

## QUICK START GUIDE

# Infinity 3U 19" Converter System

**Models: J5964803 L223 +24V to -48V**



This system: converts +24Vdc to -48Vdc using NE030DC48A converters Refer to Infinity Converter Ordering Guide for details and accessories.

### Tools Required:

- Wire cutters and strippers
- Cable crimpers
- Torque wrench-0-65 in-lb (0-10 Nm)
- Sockets - 5/16", 7/16, etc.
- Screwdrivers - Philips #1 and #2, Flat #1

### Step 1- Mount System

1. Reposition mounting ears as required for desired set back - 6 screws each. Torque to 25 in-lb (2.8Nm)-Phillips screwdriver.
2. For 23" frames-Install both 1U and 2U optional mounting brackets (separately ordered).
3. Attach shelf to the frame using a minimum of four screws (two on each side) - 12-24 (provided). Torque to 35 in-lb (4Nm)-5/16" socket. No vertical spacing is required. Provide 2 inch minimum clearance at back of system for converter airflow.

## Step 2- Plan DC Feeds

The system has three input feeds, each feeding three converter slots, and a -48V bulk output. Recommended breakers and cable sizes are in the tables below.

**Note:** Some installations do not require protectors on the inputs.

**Note:** All returns should be grounded at the power system feeding the converter shelf.

+24V in, -48V out      NE030DC48A					
Input			Output		
# Of Conv. Per feed	Input Amps	Input Cable Size (minimum)	Input Breaker Size	Output Amps	Output Cable Size (minimum)
1	80A	(1) 2 AWG	100A	30A	(1) 8 AWG
2	160A	(1) 2/0	200A	60A	(1) 6 AWG
3	240A	(2) 2/0	300A	90A	(1) 2 AWG

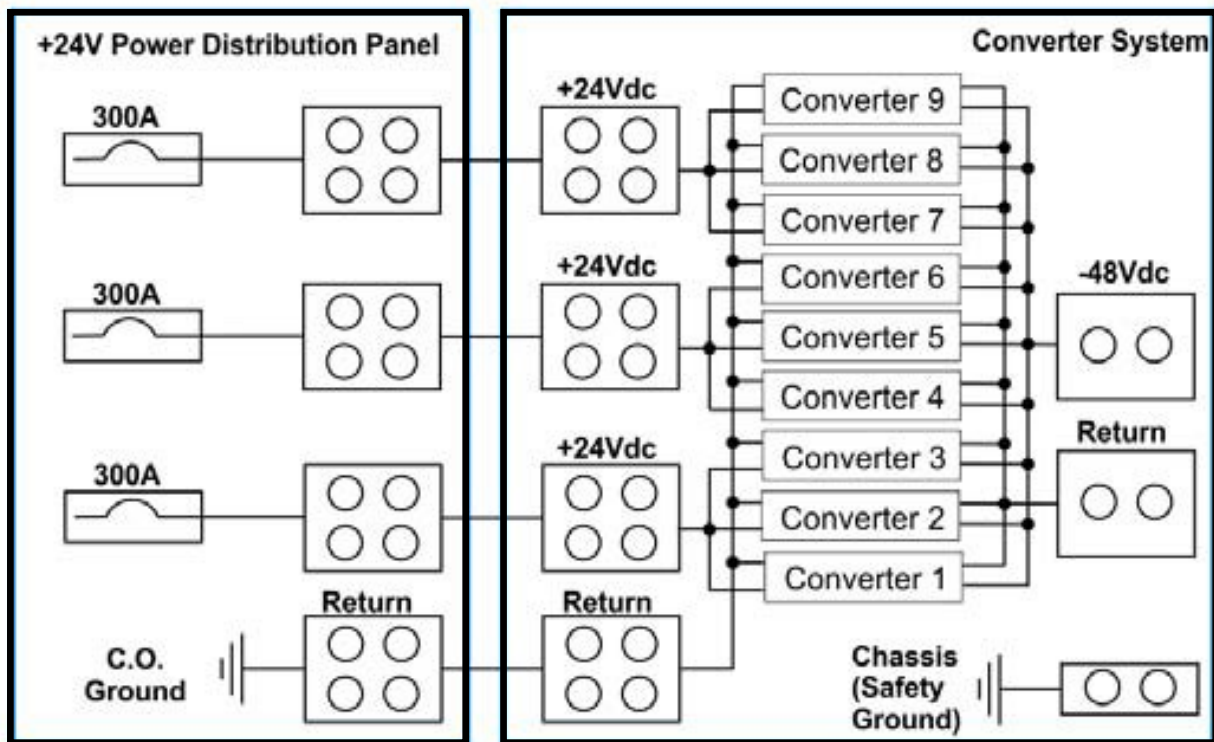

### Step 3- Connect Chassis Ground, DC Reference (CO) Ground, and DC Cables

Connections are on the rear. Not provided: lugs and lug hardware.

**CAUTION:** Verify battery voltage and polarity with a voltmeter before proceeding.

**DANGER:** Protect input cables or disconnect all input circuit protectors prior to making connections to the system.

1. Ground chassis - 6 AWG recommended, #10 or 1/4" on 5/8" center lug. Torque to 35 in-lb (4Nm) - 5/16" socket.

**Note:** Some applications rely on frame mounting screws for shelf ground omitting the shelf ground cable.

**Note:** Some applications rely on grounding a single shelf of a multi-shelf system, omitting the shelf ground cable on other shelves.

2. DC Reference Ground - Make a single DC Reference Ground connection to Output Feed Return either at the converter system or to the Return bar of external -48V distribution - 6AWG recommended.

3. Install DC cables—Lug Landings: 3/8" on 1" centers. Max tongue width: 1.4" Torque to 240 in-lb (27Nm).

**Note:** Input Feed Returns must be externally connected to DC Reference (CO) ground.

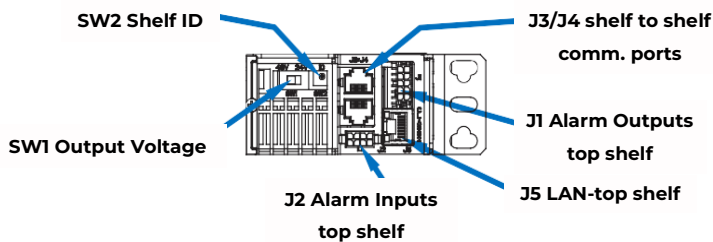
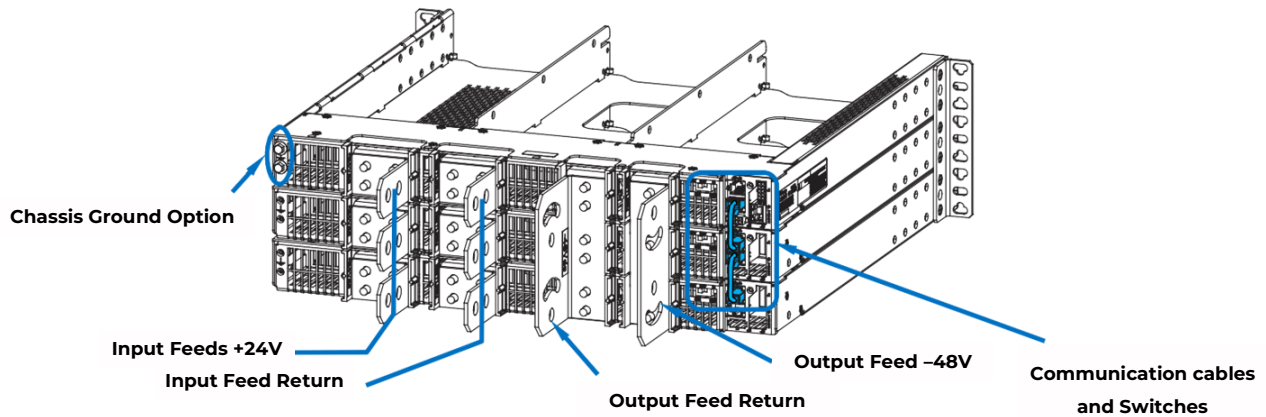

USB Craft Port

J1 ,J2 and J5 are covered on supplementary shelves

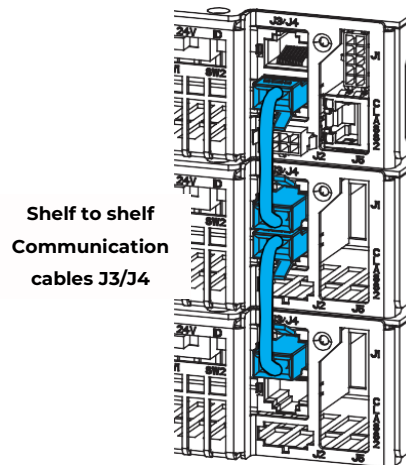

Signal Connections and Shelf Switches

## Step 4 - Install Shelf to Shelf Communications Cables

if not factory installed

Install CC848847780 shelf to shelf communication cable cables in daisy chain between all shelves-J3 /J4.

## Step 5 - Shelf Switches

SW1 Verify output voltage is set to 48V (V Sense alarm if not set correctly).

SW2 Set shelf number: 1 for bottom shelf; 2 for middle shelf, 3 for top shelf. Converter ID conflict alarm if two shelves are set to the same number.

## Step 6 - Set Jumpers - LAN Port and Relay per Galaxy Pulsar Edge Controller Quick Start Guide

1. Set Jumpers - LAN Port and Relay

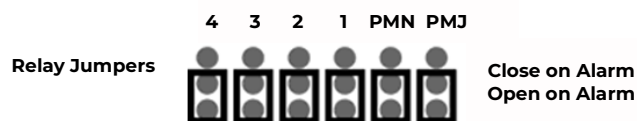

## Step 7 - Install Controller

Controller has a thumb screw to secure it to the shelf. Controller installs into the Controller Slot on the left of the shelf.

1. Align Controller in the Controller Slot.
2. Slide controller firmly into the slot.
3. Secure with thumbscrew

## Step 8 - Install Controller Communications Cables

Connectors are on rear.

See Information: Connections ... for Details

1. J1-2 Alarms and Inputs - Connect to office alarms and signals.
2. J5 LAN - Connect to Ethernet network.

## Step 9 - Install Converters

Slide the converter into the converter slot approximately 3/4 of the way.

Open the faceplate by sliding the faceplate latch to the left until the faceplate releases and swings outward.

Slide the unit into the slot until it engages with the back of the shelf. Swing the faceplate closed to fully seat the converter. Verify the faceplate is latched.

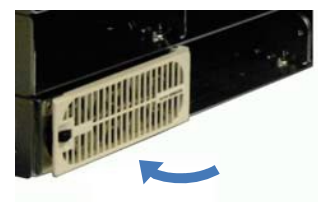
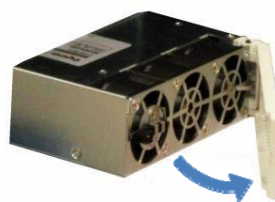

## Step 10 - Initial Start Up

Verify that all AC, DC and Alarm connections are complete and secure. Turn on DC input breakers. If there are no alarms, make required adjustments to the default settings on the controller for this installation.

## Step 11 - Configure Controller per Galaxy Pulsar Edge Controller Quick Start Guide

Verify and edit controller basic configuration parameters per site engineering instructions.

### Information: Controller Define Alarm Inputs and Outputs

#### Converter Alarm Outputs:

Select the Settings tab > Converters to set alarm thresholds, severity and relays on J1 connector.

Select the drop down arrow next to the LED field and select ALM to activate the ALM LED for that alarm condition. Factory defaults are shown in the web page to the right.

#### Auxiliary Alarm Inputs:

Select the Settings tab > Auxiliary Inputs to define up to four external alarms through connector J2.

Alarm	Severity	Relay	LED	Threshold
Converter High Voltage Major	MAJ			28.5
Converter High Voltage Minor	MIN			27
Converter Very Low Voltage	MAJ	R1	ALM	23
Multiple Converter Fail	MAJ	R2		2
Converter Redundancy Loss	MAJ	R2		1
Converter Fail	MAJ	R2		
Converter Distribution Fuse	MAJ	R3		
Converter ID Conflict	MAJ			
Converter Fan Minor	MIN	R2		

Converter Alarm Outputs: Settings tab > Converters

REF	Signal Description	Alarm Assignment	Alarm Criteria *	Click to Edit Assoc. Alarm
Internal (I001)	Fuse Alarm Major	FAJ1	CLOSED	
Internal (I002)	Open String	OSA1	CLOSED	
J2.3 (I003)	Auxiliary Major Alarm	AMJ1	CLOSED	
J2.4 (I004)	Air Conditioner Fail	AUX1	CLOSED	
J2.5 (I005)	Door Open	AUX2	CLOSED	
J2.1 (I006)	SPD Fail	AUX3	CLOSED	

Auxiliary Alarm Inputs: Settings tab > Auxiliary Inputs

### Information: Controller Default Voltage Settings and Ranges

Parameter	Range		Default	
	24V	48V	48V	24V
Converter Internal Selective High Output Voltage Shutdown	25.0 to 30.0V	50.0 to 60.0V	<b>58.0</b>	<b>29.0</b>
High Output Voltage Major Alarm	25.0 to 30.0V	50.0 to 60.0V	<b>56.0</b>	<b>28.5</b>
High Output Voltage Minor Alarm	24.0 to 30.0V	48.0 to 60.0V	<b>54.0</b>	<b>27.0</b>
Output Voltage Set-Point	23.0 to 27.2V	46.0 to 54.5V	<b>52.0</b>	<b>26.0</b>
Low Voltage Alarm	20.0 to 27.0V	40.0 to 54.0V	<b>46.0</b>	<b>23.0</b>

## Information: Connections - Alarm - J1 and J2

See the Infinity Converter Ordering Guide for details. Alarm connectors are on the rear of the shelf - J1 and J2. Change alarm descriptions via LAN port (Web pages) or Craft port (EasyView2) when required.

<b>J2</b>	
<b>Alarm Input Cable 24AWG solid</b>	
<b>Ordering code</b>	<b>Cable length</b>
CC848890203	5 ft
CC848853614	15 ft
CC848890211	50 ft
CC848890228	150 ft

<b>Pin</b>	<b>Color</b>	<b>Description</b>
1	Y	Input: SPD Fail
2	S	--
3	O	Input: AUX MAJ
4	V	Input: Air Cond. Fail
5	W	Input: Door Open
6	BL	-48V
7	BR	-48V
8	BK	-48V

<b>J1</b>	
<b>Alarm Output Cable 24GA solid</b>	
<b>Ordering Codes</b>	<b>Cable Length</b>
CC848890153	5 ft
CC848865980	15 ft
CC848817651	50 ft
CC848817668	150 ft

<b>Pin</b>	<b>Color</b>	<b>Description</b>
1	BK	Output: R3 = Rtn
2	BR	Output: R2 = Rtn
3	R	Output: R1 = Rtn
4	O	Output: PMN Rtn
5	Y	Output: PMJ Rtn
6	G	Output: R3 = Converter Distribution Fuse
7	BL	Output: R2 = Converter Fail
8	V	Output: R1 = Very Low System Voltage
9	S	Output: PMN
10	W	Output: PMJ

## Specifications and Application

Specifications and ordering information are in the Infinity Converter Brochure available at [omnionpower.com](https://omnionpower.com)

- Equipment and subassembly ports: 1. are suitable for connection to intra-building or unexposed wiring or cabling;  
2. can be connected to shielded intra-building cabling grounded at both ends.
- Grounding / Bonding Network – Connect to an Isolated Ground Plane (Isolated Bonding Network) or an Integrated Ground Plane (Mesh- Bonding Network or Common Bonding Network).
- Installation Environment - Install in Network Telecommunication Facilities, OSP, or where NEC applies.
- Battery return may be either Isolated DC return (DC-I) or Common DC return (DC-C).

### Reference Documents

These documents are available at [omnionpower.com](https://omnionpower.com)

Document	Title
850035894	Galaxy Pulsar Edge Quick Start Guide
850035895CC848815341	Pulsar Edge Controller Family Product Manual Infinity Converter Brochure

**OmniOn Power Inc.**

601 Shiloh Rd.  
Plano, TX USA

[omnionpower.com](http://omnionpower.com)

We reserve the right to make technical changes or modify the contents of this document without prior notice. OmniOn Power does not accept any responsibility for errors or lack of information in this document and makes no warranty with respect to and assumes no liability as a result of any use of information in this document.

We reserve all rights in this document and in the subject matter and illustrations contained therein. Any reproduction, disclosure to third parties or utilization of its contents – in whole or in parts – is forbidden without prior written consent of OmniOn Power. This document does not convey license to any patent or any intellectual property right. Copyright© 2023 OmniOn Power Inc. All rights reserved.