

## ORDERING GUIDE

# CPS6000 Cabinet Power System

-48V DC Outside Plant and Customer Premise Solution



## TABLE OF CONTENTS

03	Overview
04	Key Features
05–06	Specifications
07–08	Controllers
09–23	Ordering Information
24–25	References

# CPS6000 Cabinet Power System

## -48V DC Outside Plant and Customer Premise Solution

### Overview

CPS6000 systems are easy to setup and operate with a broad range of applications in outside plant and customer premise locations. The controller can be configured using either the front panel display, a laptop computer connected to the local port, or remotely using the Ethernet connection. Battery management features and options include slope thermal compensation, low voltage battery disconnect, battery high temperature alarm and battery shorted cell detection. Ideally suited for applications where space and durability in harsh environments are critical, CPS6000 is available in either front or rear wiring configurations.

### Shelf Options

CPS6000 is a -48Vdc compact power system that is 2U high (3.50 in./ 89 mm) and mounts in either 19" or 23" wide frameworks. The CPS6000 is a vertical airflow system consisting of rectifiers, ringers, controller, battery monitoring and integrated or external distribution options.

### Rectifier/Ringer Options

The CPS6000 offers a wide range of rectifiers from 10A to 50A with input voltages both in 120V and 208/240V nominal for worldwide applications. A six position rectifier shelf (300A) with external distribution panel accommodates up to 26 bullet breaker positions. The entire rectifier line is designed for operation in the temperature range -40°C to +75°C. The CPS6000 is NEBS Level 3 certified and Zone 4 rated. The CPS6000 also has an available ringer module for 100VA ring voltage generation with true 1+1 redundancy for reliable remote terminal deployment.

### Controller Options

The CPS6000 incorporates two controller types. The shelf configurations utilize the Pulsar Edge Controller which consolidates all controller functionality into a single plug-in module for higher reliability. CPS6000 systems with external distribution utilize the Pulsar Plus Controller which further extends the number of alarm relays and provides a larger display.

### Advantages

- Hardened for extreme environments
- OSP cabinet and customer premise applications
- Efficiency approaching 97%
- High density power
- 10 to 600A Systems at -48V
- Flexible AC Input

## CPS6000 TE Rectifiers



The CPS6000 TE rectifiers are designed to operate in harsh temperature environments converting AC power to DC power. Integrated into the CPS6000 Power System, the Total Efficiency™ QS Series Rectifiers provide a battery reserve system with battery management features such as slope thermal compensation, low-voltage disconnect, battery high temperature alarm and shorted cell detection.

### Applications

- OSP Cabinets
- DSL Equipment
- Customer Premise
- Indoor/outdoor wireless
- Fiber in the loop
- Digital Loop Carrier
- Data networks
- PBX

### Key Features

- Extended temp range
- Redundant fan cooling
- Front panel LED indicators
- 2U height, minimized depth
- Analog load sharing
- Constant Power Operation
- Hot pluggable
- RoHS compliant

### Input/Output

ORDERING CODE	RECTIFIER MODEL NUMBER	NOMINAL OUTPUT CURRENT	INPUT VOLTAGE*	INPUT AMPS	OUTPUT POWER**	HEAT DISSIPATION
CC109158176	QS860ATEZ Rectifier	10A	85-150Vac	5.0A	545 W	184 BTU
		10A	165-275Vac	2.8A	545 W	162 BTU
CC109158168	QS861ATEZ Rectifier	15A	85-150Vac	7.3A	818 W	210 BTU
		15A	165-275Vac	4.2A	818 W	162 BTU
CC109158184	QS862ATEZ Rectifier	25A	85-150Vac	12.0A	1362W	339 BTU
		25A	165-275Vac	6.9A	1363 W	245 BTU
CC109161758	QS863ATEZ Rectifier	25A	85-150Vac	12.0A	1362 W	339 BTU
		30A	165-275Vac	8.3A	1635 W	318 BTU
CC109158151	QS864ATEZ Rectifier	25A	85-150Vac	12.0A	1362 W	339 BTU
		40A	165-275Vac	11.1A	2180 W	424 BTU
CC109149340	QS865ATEZ Rectifier	25A	85-150Vac	12.0A	1362 W	339 BTU
		50A	165-275Vac	14.0A	2725 W	614 BTU
CC848902841	CPS6000 Insulating Rectifier Slot Filler					
150019315	QS-Blank Rectifier Chassis					

\*Operating frequency range 45-66Hz \*\*Nominal Output voltage is 54.5Vdc

## Specifications

Operating Voltage Range	42-58 Vdc
Boost Voltage	48-58 Vdc
Operating Frequency	45-66Hz
Output Voltage Regulation	+/- 0.5%
Output Ripple Noise	250mV
Psophometric Noise	2 mV
Power Factor	>0.95 for >50% loads
Total Harmonic Distortion	<5% at full load for QS863/QS864/QS865 <10% at full load for QS860/QS861/QS862

<b>ENVIRONMENTAL</b>	
Operating Temperature	-40°C to +75°C (-40°F to 167 °F)
Storage Temperature	-40°C to +85°C (-40°F to 185 °F)
Power Derating	> +55°C
Relative Humidity	0 to 95% non-condensing
Altitude	4000m max
Audible Noise	< 60dBA
<b>MECHANICAL</b>	
Length (in. / mm)	11.2 / 285
Width (in. / mm)	3.4 / 87
Height (in. / mm)	3.4 / 87
Weight (lbs. / kg)	5.75 / 2.6
<b>SAFETY AND COMPLIANCE</b>	
NEBs	Evaluated by independent NRTL test lab to Telcordia GR63 and GR1089-CORE, Issue 4 NEBs Level 3 Certified Zone 4 rated (all floor)
Safety	CE mark to low Voltage Directive 2006/95/EC and EMC Directive 2004/108/E UL 609501-1 Recognized CSA C22.2 No. 60950-1-03 Certified
RoHS	Compliant to RoHS Directive 2011/65/EU and amended Directive (EU)
EMC	FCC and EN 55022 Class B, FCC Class B
ESD	EN61000-4-2 Level 4

OUTLINE DRAWINGS

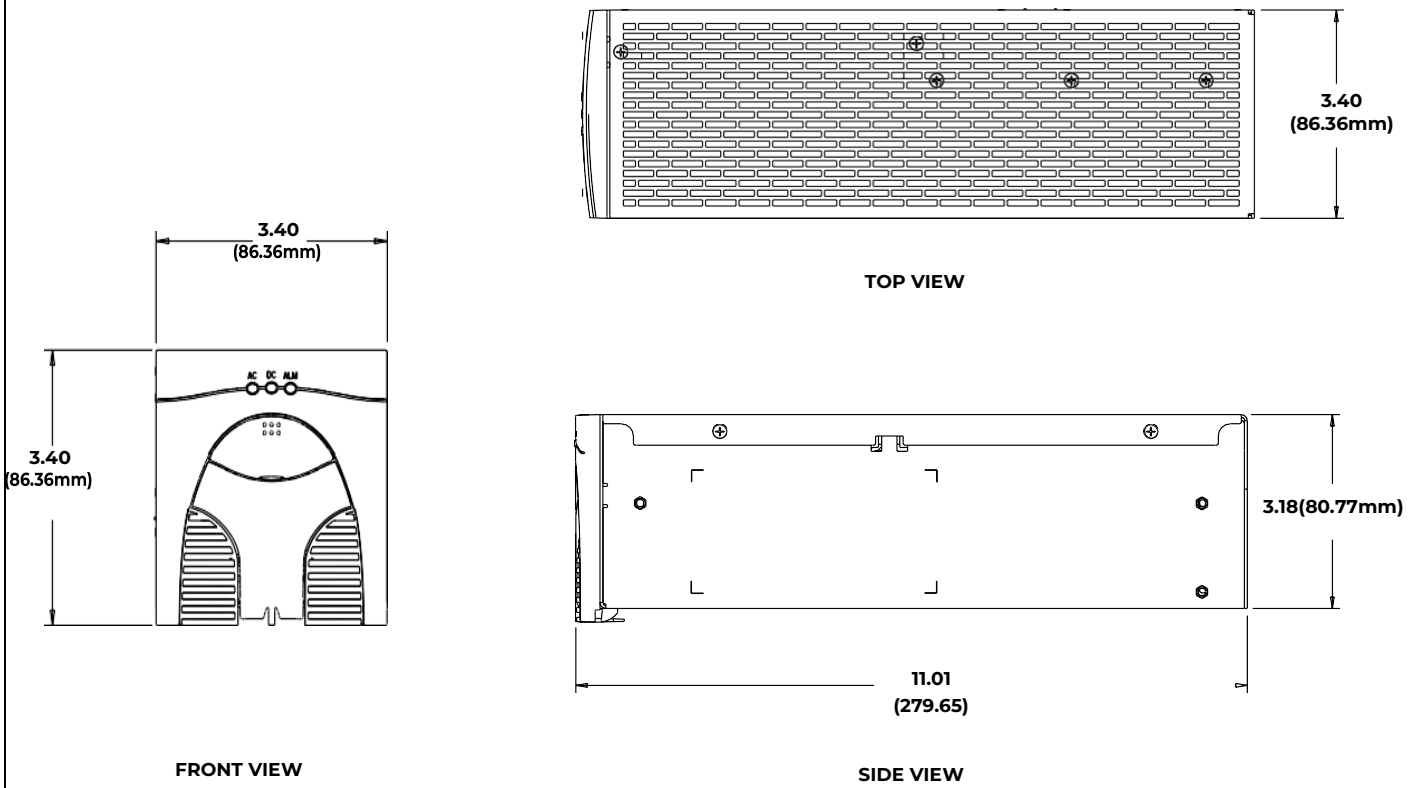

## CPS6000 Series 2 Controllers

### Pulsar Edge and Pulsar Plus System Controllers



The CPS6000 Power System is compatible with several controllers. These controllers monitor and control system components including rectifiers, converters, and distribution modules via a multi-drop RS485 digital communications bus. System status, parameters, settings, and alarm thresholds can be viewed and configured from the controller's front panel display or remote monitor ports. Assignment and configuration of alarm inputs and output relays can be performed from a laptop computer connected to a local port, or by remote access through a network connection to the World Wide Web (internet) or your enterprise network (intranet). An optional modem is also available.

These controllers utilize standard network management protocols allowing for advanced network supervision. OmniOn Power Critical Power Galaxy Manager™ software is the centralized visibility and control component of a comprehensive power management system designed to meet engineering, operations and maintenance needs. The Galaxy Manager client-server architecture enables remote access to system controllers across the power network.

<b>GENERAL</b>	
Operating Voltage	±24 Vdc, ±48 Vdc (Range: ±18 to ±60 Vdc)
Input Power	Less than 7W
Operating Temperature Range	-40°C to +75°C (-40°F to 167 °F)
Operating Relative Humidity	0 - 95% (non-condensing)
Storage Temperature Range	-40°C to +85°C (-40 to 185 °F)
Physical Specifications	Sizes vary by packaging option
Display	8-line by 40-character with alarm context sensitive backlit LCD
EMC	FCC/EN55022 Class A, CISPR22 Level A
<b>AGENCY CERTIFICATIONS</b>	
Electrostatic Discharge	EN 61000-4-2 level 4
Radiated Emissions	FCC Part 15, Class B EN55022 (CISPR22), Class A
Safety	Underwriters Laboratories (UL) Listed per Subject Letter 1801: Power Distribution Center for Communications Equipment, and cUL Certified (CSA 22.2 950): Safety of Information Technology Equipment
RoHS	Compliant to RoHS Directive 2011/65/EU and amended Directive (EU)

## Controller Feature Comparison

FEATURE	PULSAR PLUS	PULSAR EDGE
Slope Thermal Compensation	Yes	Yes
Office Alarms - Form C Relays	10	5
Binary Input Monitor Channels	10	6
Battery Test / Reserve time prediction	Yes	Yes
Battery Recharge Current Limit	Yes	Yes
Battery Monitoring - Temperature	Yes	Yes
Analog Temp Probes (Direct)	No	No
Battery Monitoring - Mid String Voltage	Yes	Yes
Battery Shunt Monitoring	Yes	Yes
Audible Alarm	Yes	No
ACO (Audible Alarm Cut Off)	Yes	N/A
Float and Boost Modes	Yes	Yes
Local RS232 Port (TI.317)	Yes	Yes
10/100 Base-T Ethernet Port for LAN	Yes	Yes
DHCP for Local Port Access	Yes	Yes
HTTP Web Server	Yes	Yes
SMTP Alarms by email / pager	Yes	Yes
SNMP v2C Remote Monitoring	Yes	Yes
Telnet / FTP (remote S/W upgrade)	Yes	Yes
Multiple Security level user access	Yes	Yes
RS485 Rectifier / Peripheral Bus	Yes	Yes
Active Rectifier Management (ARM)	Yes	Yes
Optional Modem	Yes	Yes
External Alarm Monitoring	Yes	Yes
LVBD / LVLD Contactor Control	Yes	Yes
Local Control Panel and Display	Yes	Yes
Emergency Power Off (EPO) feature	Yes	Yes
Control Panel LEDs	3	2
Non-Volatile memory for settings	Yes	Yes
Digital Rectifier communications	Yes	Yes
Rectifier Support	60	64
Converter Support	Yes	No
Derived Channels/ User Defined	Yes	Yes
History / Statistics w/ real time clock	Yes	Yes
Remote Peripheral Monitor support	No	No
User Configurable Alarm Severity	Yes	Yes
Redundancy Loss Alarm	Yes	Yes



## Ordering Information-CPS6000 Series 2 System



CPS6000 is a -48Vdc power system that is based upon a 2U high (3.50 in./ 89 mm) shelf with 19" and 23" wide mounting options. CPS6000 is a vertical airflow system consisting of rectifiers, ringers, controller, battery monitoring and either shelf integrated or external distribution options.

CPS6000 systems are easy to setup and operate. The controller can be configured using either the front panel display, a laptop computer connected to the local port, or remotely using the Ethernet connection. Battery management features and options include slope thermal compensation, low voltage battery disconnect, battery high temperature alarm and battery shorted cell detection. CPS6000 is available in either front or rear wiring configurations and up to four shelves may be interconnected. This makes CPS6000 an excellent platform to meet a wide range of applications.

### Applications

- Outside Plant (OSP)
- Digital loop carrier, remote switch, fiber in the loop, cable television
- Remote CO / Shelter Power
- Intelligent Vehicle Highway System (IVHS)
- Customer Premise applications.
- Personal Communications Service (PCS), cellular

### Features



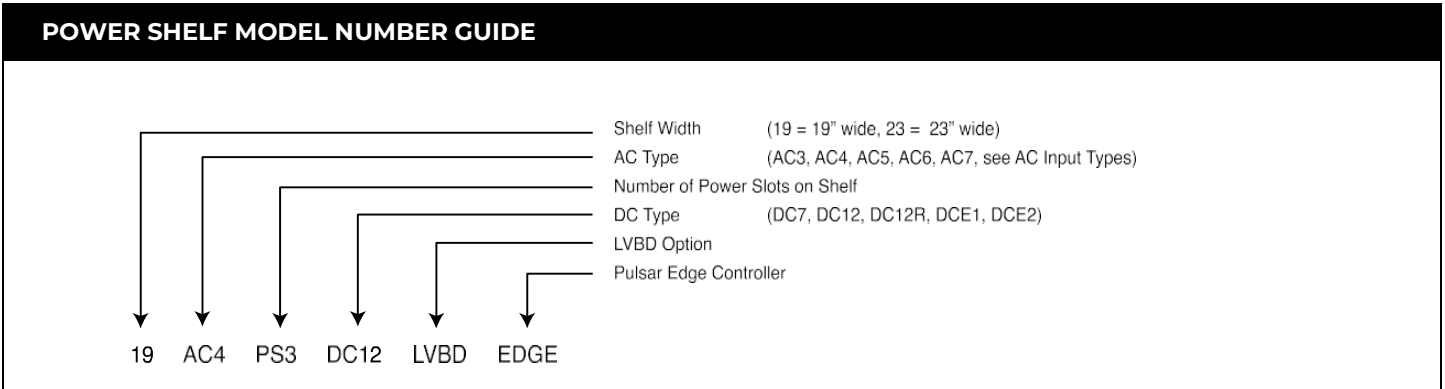

- Compact – up to 300A in a 3.5" (2U) high, 12" deep shelf
- Flexible - 19" and 23" rack mountable configurations with multiple rectifier and distribution options
- Expandable – up to two rectifier shelves can be combined with up to 2 distribution panels for larger power/distribution applications.
- Constant Power – delivers more current at lower voltages to meet load and recharge demand.
- Agency Certifications – NEBS Level 3 and UL 1801 Listed
- Wide Operating Range – worldwide auto select from 85VAC to 275VAC input.
- Temperature Hardened – continuous operation from -40°C to +75°C (-40°F to 167°F)
- Remote Access – supports standard web browsers and various internet protocols including SNMP/ TL1/SMTP/FTP. Supports DHCP client, Static IP and server mode functionality.
- Integrated Distribution Density – shelf supports up to 12 GMT fuses and 4 plug-in bullet style protectors.
- External Distribution Density – 4 RU panels support 20 (19") or 26 (23") bullet style protectors with optional LVLD and/or LVBD.

## Model Number Descriptions

Each CPS6000 power system has a model number that describes the width of the power system, type of ac input, number of power slots, and the dc distribution arrangement. Once you select a power system in Step 1 then Steps 2-9 list field installed accessories to customize the system.

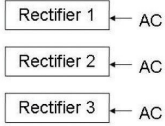
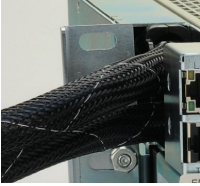
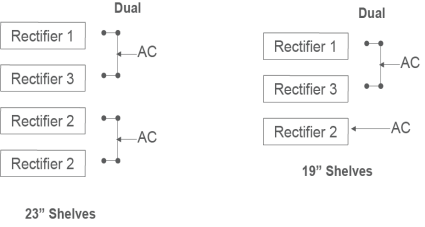
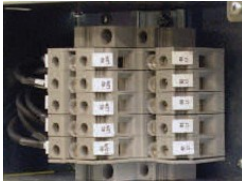
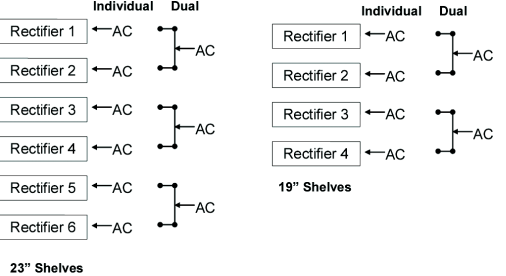

## AC Input Types

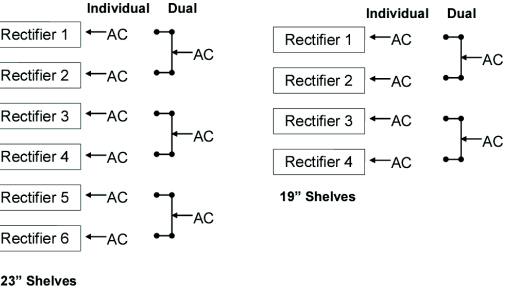
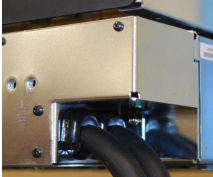
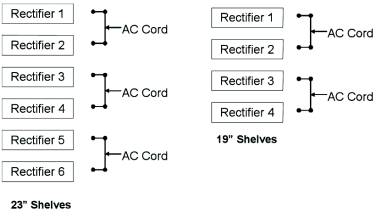
TYPE	DESCRIPTION	SCHEMATIC
AC3	Series 2 Rear Feed, IEC C13 Receptacles	 <p>Cord per Rectifier 847861192: blunt cut            CC848776105: 5-15P CC848905340: L5-15P            CC848820317: L6-20P</p>
		
AC4	Front, Dual Feed Line Cords	
		
AC5	Rear, Terminal Blocks for Individual, Single or Dual Feed Plant Systems	
		
AC6	Front, Terminal Blocks for Individual or dual feed Plant Systems.	
		
AC7	Rear AC Cords for Plant Systems.	
		

## DC Output Types

TYPE	DESCRIPTION	SCHEMATIC
DC7	4 load positions, 12 GMT fuses 3 Rear battery bulk, 1 Rear AUX position	<p>4 Circuit Breaker Battery Connections 2 hole #10 studs on 5/8" centers</p> <p>12 GMT Fuse Connections #6-32 Screws</p> <p>1 Bulk Aux Connections 2 hole #10 studs on 5/8" centers</p> <p>3 Bulk Battery Connections 2 hole #10 studs on 5/8" centers</p> <p>Optional LVD &amp; Shunt</p>
DC12		<p>12 GMT Fuse Terminal Block Connections (10GA Max)</p> <p>2 Circuit Breaker Connections 2 hole 1/4" studs on 5/8" centers</p> <p>2 Circuit Breaker Battery Connections 2 hole 1/4" studs on 5/8" centers</p> <p>Optional LVD and Shunt</p>
DC12R		<p>12 GMT Fuse Terminal Block Connections (10GA Max)</p> <p>2 Circuit Breaker Connections 2 hole 1/4" studs on 5/8" centers</p> <p>2 Circuit Breaker Battery Connections 2 hole 1/4" studs on 5/8" centers</p> <p>Optional LVD and Shunt</p>
DCE1	Single External Bullet Breaker Distribution Panel 20 Positions for 19" configuration / 26 Positions for 23" configuration Ratings: 300A output (300A discharge), 150A max breaker (75C Ambient)	<p>1 to A Breakers</p> <p>1 to B Breakers</p> <p>Configurable Battery Breaker Connections 2 hole 1/4" studs on 5/8" centers</p> <p>Configurable Load Breaker Connections 2 hole 1/4" studs on 5/8" centers</p> <p>Optional LVD &amp; Shunt</p> <p>A+B = 20 for 19" shelves and A+B = 26 for 23" shelves. Each position is configurable for load or battery.</p>
DCE2	Dual External Bullet Breaker Distribution Panel 40 Positions for 19" configuration / 52 Positions for 23" configuration Ratings: 300A output (300A discharge), 150A max breaker (75C Ambient)	<p>1 to A Breakers</p> <p>1 to B Breakers</p> <p>1 to C Breakers</p> <p>Configurable Battery Breaker Connections 2 hole 1/4" studs on 5/8" centers</p> <p>Configurable Load Breaker Connections 2 hole 1/4" studs on 5/8" centers</p> <p>Optional LVD &amp; Shunt</p> <p>A+B = 20 + C for 19" shelves and A+B = 26 + C for 23" shelves. Each position in the primary panel is configurable for load or battery. All positions in the secondary panel are 1 to C.</p>

## Step 1: Select the Power System

KITTED SHELF SOLUTIONS WITH QS841E CONTROLLER INCLUDED		
ORDERING CODE	DESCRIPTION	PHOTO
CC109169677	23-in Dual AC cord 4 slot rectifier shelf with 5-20P plugs and internal distribution; 2 load, 2 battery and 12 GMT positions, LVBD. Kit includes 15A TEZ rectifiers.	
	<ul style="list-style-type: none"> <li>(1) CPS6000 series 2 shelf, 23"</li> <li>(2) QS861ATEZ 15A rectifiers</li> <li>(2) Rectifier slot fillers</li> <li>(1) Pulsar Edge Controller (QS841E)</li> <li>(1) 15ft alarm cable</li> <li>(1) QS873A thermal probe</li> <li>(1) 10ft thermal probe cable</li> </ul>	
CC109169685	23-in Dual AC cord 4 slot rectifier shelf with L6-30P plugs and internal distribution; 2 load, 2 battery and 12 GMT positions, LVBD. Kit includes 25A TEZ rectifiers.	
	<ul style="list-style-type: none"> <li>(1) CPS6000 series 2 shelf, 23"</li> <li>(2) QS862ATEZ 25A rectifiers</li> <li>(2) Rectifier slot fillers</li> <li>(1) Pulsar Edge Controller (QS841E)</li> <li>(1) 15ft alarm cable</li> <li>(1) QS873A thermal probe</li> <li>(1) 10ft thermal probe cable</li> </ul>	
CC109171121	23-in Rear Access AC terminal box 4 slot rectifier shelf with internal rear wire distribution; 2 load, 2 battery and 12 GMT positions, LVBD. Kit includes AC cables with 5-20P plugs and 15A TEZ rectifiers.	
	<ul style="list-style-type: none"> <li>(1) CPS6000 series 2 shelf, 23"</li> <li>(2) QS861ATEZ 15A rectifiers</li> <li>(2) Rectifier slot fillers</li> <li>(1) Pulsar Edge Controller (QS841E)</li> <li>(1) 15ft alarm cable</li> <li>(1) QS873A thermal probe</li> <li>10ft thermal probe cable</li> <li>10ft AC cable</li> </ul>	
CC109171138	23-in Rear Access AC terminal box 4 slot rectifier shelf with internal rear wire distribution; 2 load, 2 battery and 12 GMT positions, LVBD. Kit includes AC cables with L6-30P plugs and 25A TEZ rectifiers.	
	<ul style="list-style-type: none"> <li>(1) CPS6000 series 2 shelf, 23"</li> <li>(2) QS862ATEZ 25A rectifiers</li> <li>(2) Rectifier slot fillers</li> <li>(1) Pulsar Edge Controller (QS841E)</li> <li>(1) 15ft alarm cable</li> <li>(1) QS873A thermal probe</li> <li>10ft thermal probe cable</li> <li>10ft AC cable</li> </ul>	

## Step 1: Select the Power System (continued)

KITTED SHELF SOLUTIONS WITH QS841E CONTROLLER INCLUDED		
ORDERING CODE	DESCRIPTION	PHOTO
CC109171146	19-in Rear Access AC terminal box 3 slot rectifier shelf with internal rear wire distribution; 2 load, 2 battery and 12 GMT positions, LVBD. Kit includes 15A TEZ rectifiers.	
	(1) CPS6000 series 2 shelf, 19" (3) QS861ATEZ 15A rectifiers (1) Pulsar Edge Controller (QS841E) (1) 15ft alarm cable (1) 19" to 23" adapter bracket kit	
CC109171154	19-in Rear Access AC terminal box 3 slot rectifier shelf with internal rear wire distribution; 2 load, 2 battery and 12 GMT positions, LVBD. Kit includes 25A TEZ rectifiers.	
	(1) CPS6000 series 2 shelf, 19" (3) QS862ATEZ 25A rectifiers (1) Pulsar Edge Controller (QS841E) (1) 15ft alarm cable (1) 19" to 23" adapter bracket kit	
CC109171162	19-in Single AC cord 3 slot rectifier shelf with L5-15P plug and internal distribution; 2 load, 2 battery and 12 GMT positions, LVLD. Kit includes 15A TEZ rectifiers.	
	(1) CPS6000 series 2 shelf, 19" (2) QS861ATEZ 15A rectifiers (1) QS850 slot filler (1) Pulsar Edge Controller (QS841E) (1) 15ft alarm cable	
CC109170437	19-in Single AC cord 3 slot rectifier shelf with L5-20P plug and internal distribution; 2 load, 2 battery and 12 GMT positions, LVLD. Kit includes 15A TEZ rectifiers.	
	(1) CPS6000 series 2 shelf, 19" (2) QS861ATEZ 15A rectifiers (1) QS841E_016R_USB Controller (1) QS873A thermal probe (1) 20ft thermal probe cable (1) 15ft alarm cable (1) 19" to 23" adapter bracket kit	

## Step 1: Select the Power System (continued)

EXTERNAL DISTRIBUTION SYSTEMS WITH PULSAR PLUS CONTROLLER						
ORDERING CODE	MODEL	WIDTH	AC	RECTIFIER SLOTS	BREAKER POSITIONS	LVD
CC109155388	19-AC5-PS4-DC1E	19"	Rear Terminal Block	4	20 Configurable	No
CC109155396	19-AC5-PS4-DC1E-LVBD	19"	Rear Terminal Block	4	20 Configurable	LVBD
CC109155413	19-AC5-PS8-DC1E	19"	Rear Terminal Block	8	20 Configurable	No
CC109155421	19-AC5-PS8-DC1E-LVBD	19"	Rear Terminal Block	8	20 Configurable	LVBD
CC109155454	19-AC5-PS8-DC2E-LVBD	19"	Rear Terminal Block	8	20 Configurable / 20 Load	LVBD
CC109156642	19-AC6-PS8-DC1E-LVBD	19"	Front Terminal Block	8	20 Configurable	LVBD
CC109156626	23-AC7-PS6-DC1E-	23"	Rear AC Cords	6	26 Configurable	LVL D
CC109158325	23-AC7-PS6-DC2E-	23"	Rear AC Cords	6	26 Configurable / 26 Load	LVL D

EXTERNAL DISTRIBUTION SYSTEMS WITH PULSAR PLUS CONTROLLER						
ORDERING CODE	MODEL	WIDTH	AC	RECTIFIER SLOTS	BREAKER POSITIONS	LVD
CC109155487	23-AC5-PS6-DC1E	23"	Rear Terminal	6	26 Configurable	No
CC109155495	23-AC5-PS6-DC1E-	23"	Rear Terminal	6	26 Configurable	LVBD
CC109155553	23-AC5-PS12-DC2E-LVBD	23"	Rear Terminal Block	12	26 Configurable / 26 Load	LVBD
CC109156691	23-AC6-PS12-DC1E	23"	Front Terminal	12	26 Configurable	No
CC109156700	23-AC6-PS12-DC1E-	23"	Front Terminal	12	26 Configurable	LVBD
CC109156725	23-AC6-PS12-DC2E	23"	Front Terminal Block	12	26 Configurable / 26 Load	No
CC109156733	23-AC6-PS12-DC2E-LVBD	23"	Front Terminal Block	12	26 Configurable / 26 Load	LVBD

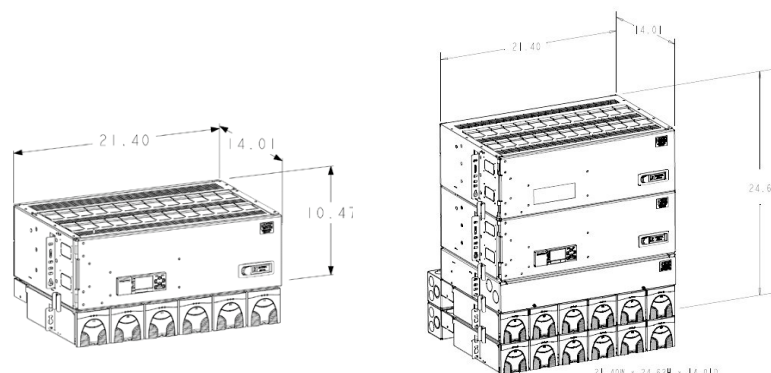

### Step 1: Select the Power System (continued)

EXTERNAL DISTRIBUTION SYSTEMS IN A FRAME WORK WITH PULSAR PLUS CONTROLLER							
ORDERING CODE	MODEL	WIDTH	AC	RECTIFIER SLOTS	DISTRIBUTION PANELS	LVD	BATTERY TRAYS
CC109160561	23-AC5-PS6-DC1E-7ftF-3BT	23"	Rear Terminal	6	1	No	3
CC109160578	23-AC5-PS6-DC1E-LVBD-7ftF-3BT	23"	Rear Terminal	6	1	LVBD	3
CC109160586	23-AC6-PS12-DC1E-7ftF-3BT	23"	Front Terminal Block	12	1	No	3
CC109160594	23-AC6-PS12-DC1E-LVBD-7ftF-3BT	23"	Front Terminal Block	12	1	LVBD	3
CC109160603	23-AC7-PS6-DC1E-LVLD-7ftF-2BT	23"	Rear AC	6	1	LVLD	2
CC109160611	23-AC7-PS6-DC2E-LVLD-7ftF-4BT	23"	Rear AC	6	2	LVLD	4

BULK RETROFIT SOLUTIONS							
ORDERING CODE	MODEL	WIDTH	AC INPUT	RECTIFIER SLOTS	LOAD POSITION	BATTERY POSITION	LVD
CC109167334	23-AC5-PS6-BULK	23"	Rear Terminal	6	Bulk	Bulk	No
CC109157855	23-AC5-PS6-BULK Supplemental Shelf	23"	Rear Terminal	6	Bulk	Bulk	No
CC109167136	23-AC6-PS12-BULK	23"	Front Terminal	12	Bulk	Bulk	No





## Step 1: Select the Power System (continued)

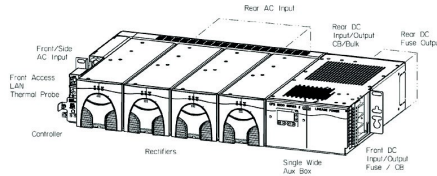

SHELF SYSTEMS USES PULSAR EDGE (QS841E) CONTROLLER (CONTROLLER NOT INCLUDED)							
ORDERING CODE	MODEL	WIDTH	AC INPUT	RECTIFIER SLOTS	LOAD POSITION	BATTERY POSITION	LVD
CC109161130	19-AC4S-PS3-DC12-EDGE	19"	Single Line Cord	3	2 Bullet, 12 GMT	2 Bullet Breakers	No
CC109170420	19-AC4-PS3-DC12-LVLD-EDGE - 1L5-15P	19"	Dual Feed Line Cords	3	2 Bullet, 12 GMT	2 Bullet Breakers	LVLD
CC109161865	19-AC3-PS3-DC12-EDGE	19"	Individual IEC Plug	3	2 Bullet, 12 GMT	2 Bullet Breakers	No
CC109163556	19-AC3-PS3-DC12- LVBDEEDGE	19"	Individual IEC Plug	3	2 Bullet, 12 GMT	2 Bullet Breakers	LVB D
CC109159488	19-AC4-PS3-DC12-EDGE	19"	Dual Feed Line Cords	3	2 Bullet, 12 GMT	2 Bullet Breakers	No
CC109160173	19-AC4-PS3-DC12-LVBD-EDGE	19"	Dual Feed Line Cords	3	2 Bullet, 12 GMT	2 Bullet Breakers	LVB D
CC109170981	19-AC5-PS3-DC7-EDGE	19"	Rear Terminal	3	4 Bullet, 12 GMT	3 Rear Bulk	No
CC109161378	19-AC5-PS3-DC7-LVBD-EDGE	19"	Rear Terminal	3	4 Bullet, 12 GMT	3 Rear Bulk	LVB D
CC109161898	19-AC5-PS3-DC12R-EDGE	19"	Rear Terminal	3	2 Bullet, 12 GMT	2 Bullet Breakers	No
CC109161907	19-AC5-PS3-DC12R-LVBD-EDGE	19"	Rear Terminal	3	2 Bullet, 12 GMT	2 Bullet Breakers	LVB D
CC109163721	19-AC5-PS3-DC12-EDGE	19"	Rear Terminal	3	2 Bullet, 12 GMT	2 Bullet Breakers	No
CC109163738	19-AC5-PS3-DC12-LVBD-EDGE	19"	Rear Terminal	3	2 Bullet, 12 GMT	2 Bullet Breakers	LVB D
CC109165164	19-AC5-PS3-DC8-EDGE	19"	Rear Terminal	3	4 Bullet	3 Rear Bulk	No
CC109161147	19-AC5-PS4-BULK-EDGE	19"	Rear Terminal	4	Bulk	Bulk	No
CC109161873	23-AC3-PS4-DC12-EDGE	23"	Individual IEC Plug	4	2 Bullet, 12 GMT	2 Bullet Breakers	No
CC109163564	23-AC3-PS4-DC12- LVBD-EDGE	23"	Individual IEC Plug	4	2 Bullet, 12 GMT	2 Bullet Breakers	LVB D
CC109159463	23-AC4-PS4-DC12-EDGE	23"	Dual Feed Line Cords	4	2 Bullet, 12 GMT	2 Bullet Breakers	No
CC109160181	23-AC4-PS4-DC12-LVBD-EDGE	23"	Dual Feed Line Cords	4	2 Bullet, 12 GMT	2 Bullet Breakers	LVB D
CC109169900	23-AC4-PS4-DC12-LVBD-EDGE -5 -20P	23"	Dual Feed Line Cords	4	2 Bullet, 12 GMT	2 Bullet Breakers	LVB D
CC109169917	23-AC4-PS4-DC12-LVBD-EDGE -L6 -30P	23"	Dual Feed Line Cords	4	2 Bullet, 12 GMT	2 Bullet Breakers	LVB D
CC109170998	23-AC5-PS4-DC7-EDGE	23"	Rear Terminal	4	4 Bullet, 12 GMT	3 Rear Bulk	No
CC109164851	23-AC5-PS4-DC7-LVBD-EDGE	23"	Rear Terminal	4	4 Bullet, 12 GMT	3 Rear Bulk	LVB D

## Step 1: Select the Power System (continued)

SHELF SYSTEMS USES PULSAR EDGE (QS841E) CONTROLLER (CONTROLLER NOT INCLUDED)							
ORDERING CODE	MODEL	WIDTH	AC INPUT	RECTIFIER SLOTS	LOAD POSITION	BATTERY POSITION	LVD
CC109159455	23-AC5-PS4-DC12R-EDGE	23"	Rear Terminal	4	2 Bullet, 12 GMT	2 Bullet Breakers	No
CC109160198	23-AC5-PS4-DC12R-LVBD-EDGE	23"	Rear Terminal	4	2 Bullet, 12 GMT	2 Bullet Breakers	LVBD
CC109163746	23-AC5-PS4-DC12-EDGE	23"	Rear Terminal	4	2 Bullet, 12 GMT	2 Bullet Breakers	No
CC109163754	23-AC5-PS4-DC12-LVBD-EDGE	23"	Rear Terminal	4	2 Bullet, 12 GMT	2 Bullet Breakers	LVBD
CC109161163	23-AC5-PS5-BULK-EDGE	23"	Rear Terminal	5	Bulk	Bulk	No

## Step 2: Select Rectifiers and Ringers

RECTIFIERS						
ORDERING CODE	RECTIFIER MODEL NUMBER	NOMINAL OUTPUT CURRENT	INPUT VOLTAGE*	INPUT AMPS	OUTPUT POWER**	HEAT DISSIPATION
CC109158176	QS860ATEZ Rectifier	10A	85-150Vac	5.0A	545 W	184 BTU
		10A	165-275Vac	2.8A	545 W	162 BTU
CC109158168	QS861ATEZ Rectifier	15A	85-150Vac	7.3A	818 W	210 BTU
		15A	165-275Vac	4.2A	818 W	162 BTU
CC109158184	QS862ATEZ Rectifier	25A	85-150Vac	12.0A	1362 W	339 BTU
		25A	165-275Vac	6.9A	1363 W	245 BTU
CC109161758	QS863ATEZ Rectifier	25A	85-150Vac	12.0A	1362 W	339 BTU
		30A	165-275Vac	8.3A	1635 W	318 BTU
CC109158151	QS864ATEZ Rectifier	25A	85-150Vac	12.0A	1362 W	339 BTU
		40A	165-275Vac	11.1A	2180 W	424 BTU
CC109149340	QS865ATEZ Rectifier	25A	85-150Vac	12.0A	1362 W	339 BTU
		50A	165-275Vac	14.0A	2725 W	614 BTU
CC848902841	CPS6000 Insulating Rectifier Slot Filler					
150019315	QS-Blank Rectifier Chassis					



RINGERS					
ORDERING CODE	DESCRIPTION				PHOTO
		Output Current	Input Voltage	Input Amperage	
108990082	QS820A Ringer	1 or 2 Ringers plug into Ringer Chassis.			
108991337	QS820A Ringer Kit	Chassis occupies a single slot in the rectifier shelf (includes 1 ringer)			
847922101	Ringer Output Cable (connects to Ringer Chassis)	15-foot cable			
CC84880476		150-foot cable			
Ringers convert -48Vdc to a 100VA ringing power output with configurable ac voltage, ac frequency, and dc offset. The ringing output can be either Redundant (1+1 ringer module) or non-redundant (1 ringer module). The QS820M ringer chassis mounts in the rightmost available power slot.					

### Step 3: Select AC Cord

Example: 208/240VAC for a 23-AC1-PS4-DC3 shelf using 15A rectifiers would use a CC848862532 ac 10 gauge single cord set. Customer should provide one 30A protecting circuit breaker. Note: If PS# of your shelf model number is not listed in table, choose the next higher number. AC cords are 10 feet long and unterminated on the end. See optional accessories for twist lock connectors

ORDERING CODE	AC TYPE	GAUGE	SHELF TERMINATION	ORDER # OF			LENGTH	USER TERMINATION	120 VAC	208/240 VAC
				SHELF	DUAL	INDIV.				
847861192	AC3	14	IEC C13 Plug				10'	Unterminated	X	X
CC848776105			IEC C13 Plug				10'	5-15P	X	
CC848905340			IEC C13 Plug				15'	L5-15P	X	
CC848820317			IEC C13 Plug				10'	L6-20P		X
N/A	AC4	10	Hard Wired	N/A	N/A	N/A	N/A	N/A	N/A	N/A
CC109171204	AC5	14	Ferrules	1			10'	5-15P	X	
850039625			Ferrules	1			10'	L5-15P	X	
CC848905332		12	Ferrules	1			15'	L6-20P		X
CC109171170		10	Ferrules	1			10'	L6-30P		X
CC109154976			Ferrules	1			20'	L6-30P		X
CC109155330			Ferrules	1			20'	Unterminated	X	X
CC848905332		AC6	12	Ferrules	1			15'	L6-20P	
CC109154976	10		Ferrules	1			20'	L6-30P		X
CC109155330			Ferrules	1			20'	Unterminated	X	X
N/A	AC7	10	Hard Wired	N/A	N/A	N/A	N/A	N/A	N/A	N/A

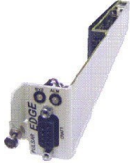
### Step 4: Select Controller

ORDERING CODE	DESCRIPTION	PHOTO
CC109156535	Pulsar Edge Controller (QS841E)	
CC109142056	Pulsar Plus Controller (NE843E)  NOTE: Included in Systems with External Distribution. Order for spares only.	

## Step 5: Select Alarm Cables

ORDERING CODE	DESCRIPTION	PHOTO
CC848817651	50ft Auxiliary input alarm cable for Pulsar Plus Controller	
CC848817668	150ft auxiliary input alarm cable for Pulsar Plus Controller	
CC109157442	15ft alarm cable for Pulsar Plus Controller (for systems with external distribution)	
CC848817635	50ft alarm cable for Pulsar Plus Controller (for systems with external distribution)	
CC848817643	150ft alarm cable for Pulsar Plus Controller (for systems with external distribution)	
CC848890178	15ft alarm cable for Pulsar Edge Controller	
CC848890186	50ft alarm cable for Pulsar Edge Controller	
CC848890194	150ft alarm cable for Pulsar Edge Controller	

## Step 6: Select Battery Monitoring

ORDERING CODE	DESCRIPTION	PHOTO
CC109142980	QS873A Thermal Probe (A)	
CC848817024	10 ft wire set (B: thermal probe to controller)	
CC109157434	20 ft wire set (B:thermal probe to controller)	
CC848822560	1 ft wire set (C: thermal probe to thermal probe)	
848719803	5 ft wire set (C: thermal probe to thermal probe)	
CC848822321	10 ft wire set (C: thermal probe to thermal probe)	
850027334	20 ft wire set (C: thermal probe to thermal probe)	
108958422	ES771A Battery Voltage Monitor Card	
CC848791517	2-1/2 ft wire (D: ES771A to thermal probe)	
CC848797290	6 ft wire set (D: ES771A to thermal probe)	
848719829	10 ft wire set (D: ES771A to thermal probe)	
CC848791500	4 ft wire set (G: ES771A to ES771A or controller)	
848652947	10 ft wire set (G: ES771A to ES771A or controller)	
555052-1	In-Line Coupler	

Temperature/Voltage probes are needed for battery monitoring. They are connected to each battery or battery string to provide slope thermal compensation, temperature alarms and voltage imbalance alarms.

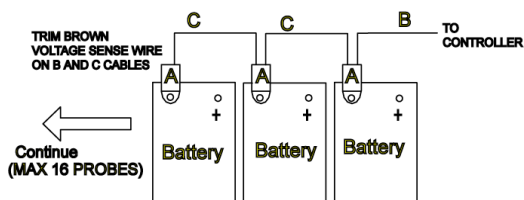

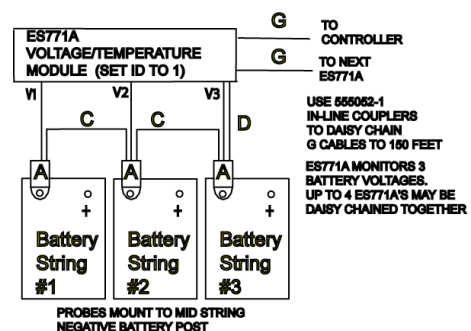

Temperature Measurement



Temperature and Voltage Measurement

## Step 7: Select Distribution Components

<b>BULLET BATTERY CIRCUIT BREAKERS (YELLOW HANDLE) (ALARMS ON MID-TRIP AND IN OF F POSITION)</b>				
<b>ORDERING CODE</b>	<b>AMPERAGE</b>	<b>ORDERING CODE</b>	<b>AMPERAGE</b>	<b>PHOTO</b>
CC408612758	30	CC408574387	70	
CC408612766	40	CC408574395	100	
CC408612774	45	CC408574404	125 (2-pole)	
CC408574370	50	CC408574412	150 (2-pole)	
408560123	60	CC408574420	200 (2-pole)	
CC109106548	100A battery bullet bus strap (substitute for battery breaker)			

<b>BULLET LOAD CIRCUIT BREAKERS (ALARMS ON MID-TRIP)</b>				
407998137	3	407998236	60	
407998145	5	407998244	70	
407998152	10	407998251	80	
407998160	15	407998269	90	
407998186	20	407998277	100	
407998194	25	CC848808551	100 (2-pole)	
407998202	30	408185353	125 (2-pole)	
408213486	40	408185346	150 (2-pole)	
407998210	45	408564941	200 (3-pole)	
407998228	50			
850021775	2-pole Adapter bus for 100-150A breakers; used for 3/8" on 1" Lugs (order 2 per 2 pole breaker to accommodate load and return lugs)			
CC848756916	2-pole Adapter bus for 100-150A breakers; used for 1/4" on 5/8" Lugs (order 2 per 2 pole breaker to accommodate load and return lugs)			
850021955	3-pole Adapter bus for 200-250A breakers; used for 3/8" on 1" Lugs (order 2 per 3 pole breaker to accommodate load and return lugs)			
CC848756924	3-pole Adapter bus for 200-250A breakers; used for 1/4" on 5/8" Lugs (order 2 per 3 pole breaker to accommodate load and return lugs)			

## Step 7: Select Distribution Components (continued)

<b>BULLET STYLE FUSE HOLDER AND TPS FUSES</b>				
<b>ORDERING CODE</b>	<b>AMPERAGE</b>	<b>ORDERING CODE</b>	<b>AMPERAGE</b>	<b>PHOTO</b>
406700567	3	406700633	25	
406700583	5	406700641	30	
406700591	6	406700658	40	
406700609	10	406700674	50	
406700617	15	406700682	60	
406700625	20	406700690	70	
402328926	0.18 Alarm Fuse			
408548944	Bullet Fuse Holder, TFD-101-011-09 (Alarms on Blown Fuse or Fuse			
CC408617410	Bullet Fuse Holder, TFD-101-011-10 (Alarms on Blown Fuse Only)			

### GMT FUSES

405006222	0.25A	406159061	5A	
3150439	0.5A	405725433	7.5A	
401841473	1A	406159236	10A	
405673146	1.33A	407845197	12A	
405181983	2A	406473959	15A	
406976985	3A	408555453	20A	

### FUSE ACCESSORIES

408515823	Fuse Puller
402099436	Dummy Fuse
CC109103157	6 Position GMT Bullet Fuse Holder

## Step 8: Select Lugs

<b>STRAIGHT LUG (1/4" BOLT ON 5/8" CENTERS) FOR DC1, DC2 REAR OUTPUT, DC4 TOP BATTERY</b>					
<b>ORDERING CODE</b>	<b>STR WIRE GA (CLASS B)</b>	<b>FLEX WIRE GA (CLASS I)</b>	<b>WP-91412 LIST</b>	<b>PHOTO</b>	
406021626*	8	8	75		
405347519*	6	6	3		
405347576*	4	4	5		
405348202*	2	-	54		
405347683*	-	2	8		
<b>STRAIGHT LUG (#10 BOLT ON 5/8" CENTERS) FOR DC2, DC3, DC4, DC6 LOAD</b>					
405356171*	14-10	14-10	73		
405348178*	8	8	52		
406338400*	6	6	108		
<b>STRAIGHT LUG (1/4" BOLT ON 3/4" CENTERS) FOR DC5 REAR OUTPUT</b>					
406338343	8	8	103		
406338442	6	6	110		
406338574	4	4	117		
406338673	2	-	122		

\* Order 848201919 Hardware Kits (grade 2) for each Return Lug. Hardware is provided for Load Lugs.

## Step 9: Select Optional Accessories

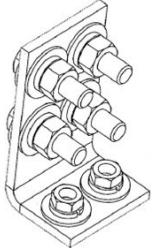
ORDERING CODE	DESCRIPTION	PHOTO
848683009	19" to 23" Adapter Bracket Kit	
850022254	Battery Lug Connection Bus Kit Used to expand bulk battery landing capacity on external distribution panels. Order (1) for -48V and (1) for Return	
CC109160446	Distribution Hardware Kit	
150024415	Perpendicular Wall mount bracket (shelf stands off from the wall)	
CC848864504	Flush wall mount bracket (shelf is flat on the wall)	
CC408628515	5-15P 15A 120V straight male AC plug	
CC408644917	L6-15P 15A 120V twist lock male AC plug	
CC408642961	L5-20P 20A 120V twist lock male AC plug	
CC408627062	L6-20P 20A 240V twist lock male AC plug	
402530976	L6-30P 30 amp twist lock male AC plug	
450024122	L6-30R 30 amp twist lock female AC connector	
450024416	L6-50P 50 amp twist lock plug	
450024417	L6-50R 50 amp twist lock connector	

## Cabinet Power System

- Vertical Airflow
- 12" Depth Applications
- Rectifier and Ringers
- Flexible Distribution Options
- Temperature Hardened

## Intelligence

- Industry leading controller features
- Ethernet interface for remote access
- Centralized network management

## Investment Protection

- Retrofit Applications
- Leverage Deployed Solutions
- Flexible Upgrade Options

## On Time Delivery

- Standard building blocks
- 4 - 6 week availability
- 24/7 technical support

## Management Visibility

Galaxy Manager\* software is the centralized visibility and control component of a comprehensive power management system designed to meet engineering, operations and maintenance needs. The Galaxy Manager client-server architecture enables remote access to system controllers across the power network.

- Dashboard display with one-click access to management information database
- Trend analysis
- Scheduled or on demand reports
- Fault, configuration, asset, and performance management

## Training

Omnion Power offers on-site and classroom training options based on certification curriculum. Technical training can be tailored to individual customer needs. Training enables customers and partners to more effectively manage and support the power infrastructure. We have built our training program on practical learning objectives that are relevant to specific technologies or infrastructure design objectives.

## Service & Support

Omnion Power field service and support personnel are trusted advisors to our customers – always available to answer questions and help with any project, large or small. Our certified professional services team consists of experts in every aspect of power conversion with the resources and experience to handle large turnkey projects along with custom approaches to complex challenges. Proven systems engineering and installation best practices are designed to safely deliver results that exceed our customers' expectations.

## Warranty

Omnion Power is committed to providing quality products and solutions. We have developed a comprehensive warranty that protects you and provides a simple way to get your products repaired or replaced as soon as possible.

For full warranty terms and conditions please go to

[omnionpower.com](https://www.omnionpower.com)



**OmniOn Power Inc.**

601 Shiloh Rd.  
Plano, TX USA

[omnionpower.com](http://omnionpower.com)

We reserve the right to make technical changes or modify the contents of this document without prior notice. OmniOn Power does not accept any responsibility for errors or lack of information in this document and makes no warranty with respect to and assumes no liability as a result of any use of information in this document.

We reserve all rights in this document and in the subject matter and illustrations contained therein. Any reproduction, disclosure to third parties or utilization of its contents – in whole or in parts – is forbidden without prior written consent of OmniOn Power. This document does not convey license to any patent or any intellectual property right. Copyright© 2023 OmniOn Power Inc. All rights reserved.