

DATASHEET

QSVW042A0B Barracuda Series* Power Modules; DC-DC Converters

36V_{dc}-75V_{dc} Input; 12V_{dc} Output; 42A, Output Current

RoHS Compliant



Description

The QSVW042A0B Barracuda series of dc-dc converters are a new generation of DC/DC power modules designed to support 9.6 - 12V_{dc} intermediate bus applications where multiple low voltages are subsequently generated using point of load (POL) converters, as well as other application requiring a tightly regulated output voltage. The QSVW042A0B series operate from an input voltage range of 36 to 75V_{dc}, and provide up to 42A output current at output voltages from 6.0V_{dc} to 12.0V_{dc}. The 12V

output is well regulated for the entire input voltage range. The QSVW042A0B has improved line transient performance as compared to earlier generation modules. The converter incorporates digital control, synchronous rectification technology, and innovative packaging techniques to achieve efficiency reaching 96% peak at 12V_{dc} output. This leads to lower power dissipations such that for many applications a heat sink is not required. Standard features include output voltage trim, remote sense, on/off control, output overcurrent and over voltage protection, over temperature protection, input under and over voltage lockout. The output is fully isolated from the input, allowing versatile polarity configurations and grounding connections. Built-in filtering for both input and output minimizes the need for external filtering.

Applications

- Distributed power architectures
- Intermediate bus voltage applications
- Servers and storage applications
- Networking equipment including Power over Ethernet(PoE)
- Fan assemblies other systems requiring a tightly regulated output voltage

Options

- Negative Remote On/Off logic (1=option code, factory preferred)
- Auto-restart after fault shutdown (4=option code, factory preferred)
- Remote Sense and Output Voltage Trim (9=option code)
- Passive Droop Load Sharing (-P=option code)
- Higher Output Capacitance (-Q=option code)

See Footnotes On Page:2

Features

- Compliant to RoHS Directive 2011/65/EU and amended Directive (EU) 2015/863.
- Compliant to REACH Directive (EC) No 1907/2006
- Compatible with reflow pin/paste soldering process
- High efficiency – 95% at 12V_{dc}, 50% load to 100% load
- Wide Input voltage range: 36-75V_{dc}
- Delivers up to 42A_{dc} output current
- Output Voltage adjust: 6.0V_{dc} to 13.2V_{dc}
- Tightly regulated output voltage
- Low output ripple and noise
- Industry standard, DOSA compliant, Quarter brick: 58.4mm x 36.8 mm x 12.57mm (2.30in x 1.45 in x 0.495 in)
- Base plate option (-H=option code)[&]
- Constant switching frequency
- Positive Remote On/Off logic
- Output over current/voltage protection
- Over temperature protection
- Wide operating temperature range (-40°C to 85°C)
- ANSI/UL* 62368-1 and CAN/CSA† C22.2 No. 62368-1 Recognized, DIN VDE‡ 0868-1/A11:2017 (EN62368-1:2014/A11:2017)
- CE mark 73/23/EEC and 93/68/EEC directives[§]
- Meets the voltage and current requirements for ETSI 300- 132-2 and complies with and licensed for Basic insulation rating per EN62368-1
- 2250 V_{dc} Isolation tested in compliance with IEEE 802.3[¶] PoE standards
- ISO** 9001 and ISO14001 certified manufacturing facilities

Footnotes

* Trademark of OmniOn Electric Company

UL is a registered trademark of Underwriters Laboratories, Inc.

† CSA is a registered trademark of Canadian Standards Association.

‡ VDE is a trademark of Verband Deutscher Elektrotechniker e.V.

§ This product is intended for integration into end-user equipment . All of the required procedures of end-use equipment should be followed.

¶ IEEE and 802 are registered trademarks of the Institute of Electrical and Electronics Engineers, Incorporated.

** ISO is a registered trademark of the International Organization of Standards.

Technical Specifications

Absolute Maximum Ratings

Stresses in excess of the absolute maximum ratings can cause permanent damage to the device. These are absolute stress ratings only, functional operation of the device is not implied at these or any other conditions in excess of those given in the operations sections of the data sheet. Exposure to absolute maximum ratings for extended periods can adversely affect the device reliability.

Parameter	Device	Symbol	Min	Max	Unit
Input Voltage*					
Continuous		V_{IN}	-0.3	75	V_{dc}
Operating transient $\leq 100\text{ms}$				100	V_{dc}
Operating Input transient slew rate, $50V_{IN}$ to $75V_{IN}$ (Output may exceed regulation limits, no protective shutdowns shall activate, $C_O=220\mu\text{F}$ to $C_{O, max}$)		-	-	5	$\text{V}/\mu\text{s}$
Non- operating continuous		V_{IN}	80	100	V_{dc}
Operating Ambient Temperature (See Thermal Considerations section)	All	T_A	-40	85	$^{\circ}\text{C}$
Storage Temperature	All	T_{stg}	-55	125	$^{\circ}\text{C}$
I/O Isolation Voltage (100% factory Hi-Pot tested)	All	-	-	2250	V_{dc}

* Input over voltage protection will shut down the output voltage when the input voltage exceeds threshold level.

Electrical Specifications

Unless otherwise indicated, specifications apply over all operating input voltage, resistive load, and temperature conditions.

Parameter	Device	Symbol	Min	Typ	Max	Unit
Operating Input Voltage		V_{IN}	36	48	75	V_{dc}
Maximum Input Current ($V_{IN}=0\text{V}$ to 75V , $I_O=I_{O, max}$)		$I_{IN, max}$	-	-	17.5	A_{dc}
Input No Load Current ($V_{IN} = V_{IN, nom}$, $I_O = 0$, module enabled)	All	$I_{IN, No load}$		120		mA
Input Stand-by Current ($V_{IN} = V_{IN, nom}$, module disabled)	All	$I_{IN, stand-by}$			30	mA
External Input Capacitance	All		100	-	-	μF
Inrush Transient	All	I^2t	-	-	1	A^2s
Input Terminal Ripple Current (Measured at module input pin with maximum specified input capacitance and $< 500\mu\text{H}$ inductance between voltage source and input capacitance $C_{IN}=220\mu\text{F}$, 5Hz to 20MHz, $V_{IN}= 48\text{V}$, $I_O= I_{Omax}$)	All		-	500	-	mA_{rms}
Input Reflected Ripple Current, peak-to-peak (5Hz to 20MHz, $12\mu\text{H}$ source impedance; $V_{IN}= 48\text{V}$, $I_O= I_{Omax}$; See Figure 11)	All		-	70	-	mA_{p-p}
Input Ripple Rejection (120Hz)	All		-	50	-	dB
Output Voltage Set-point (Default) ($V_{IN}=V_{IN, nom}$, $I_O=21\text{A}$, $T_A =25^{\circ}\text{C}$)	All	$V_{O, set}$	11.97	12.00	12.03	V_{dc}
Output Voltage Over all operating input voltage, resistive load, and temperature conditions until end of life	All w/o -P -P Option	V_O V_O	11.76 11.63	— —	12.24 12.37	V_{dc} V_{dc}

CAUTION: This power module is not internally fused. An input line fuse must always be used.

This power module can be used in a wide variety of applications, ranging from simple standalone operation to an integrated part of sophisticated power architecture. To preserve maximum flexibility, internal fusing is not included, however, to achieve maximum safety and system protection, always use an input line fuse. The safety agencies require a fast-acting fuse with a maximum rating of 25A (see Safety Considerations section). Based on the information provided in this Data Sheet on inrush energy and maximum dc input current, the same type of fuse with a lower rating can be used. Refer to the fuse manufacturer's Data Sheet for further information.

Technical Specifications (continued)

Electrical Specifications (continued)

Parameter	Device	Symbol	Min	Typ	Max	Unit
Output Regulation						
Line	All w/o -P		—	0.2	—	% $V_{O, set}$
Load	All w/o -P		—	0.2	—	% $V_{O, set}$
Line	-P Option		—	0.5	—	% $V_{O, set}$
Load, Intentional Droop	-P Option		—	0.50	—	V_{dc}
Temperature ($T_A = -40^\circ\text{C}$ to $+85^\circ\text{C}$)	All		—	2	—	% $V_{O, set}$
Output Ripple and Noise on nominal output ($V_{IN}=V_{IN, nom}$ and $I_O=I_{O, min}$ to $I_{O, max}$, tested with a 1.0 μF ceramic, 10 μF aluminum and 220 μF polymer capacitor across the load.)						
RMS (5Hz to 20MHz bandwidth)	All		—	70	—	mV_{rms}
Peak-to-Peak (5Hz to 20MHz bandwidth)	All		—	200	—	mV_{pk-pk}
External Output Capacitance	All except -Q	C_O	220	—	10,000	μF
For $C_O > 5000\mu\text{F}$, I_O must be $< 50\%$ $I_{O, max}$ during T_{rise} .	-Q Option		6000		15,500	
Output Current	All	I_O	0		42	A_{dc}
Output Overcurrent Protection	All		46.2		54.6	A_{dc}
Efficiency $V_{IN}=V_{IN, nom}$, $V_O = V_{O, set}$ $T_A=25^\circ\text{C}$						
$I_O=100\%$ $I_{O, max}$	All	η		95.0		%
$I_O=55\%$ - 90% $I_{O, max}$	All	η		95.7		%
Switching Frequency (Primary FETs) (primary MOSFETs) (Output Ripple 2X switching frequency)		f_{sw}		150		kHz
Dynamic Load Response $di_O/dt=1A/10\mu\text{s}$; $V_{in}=V_{in, nom}$; $T_A=25^\circ\text{C}$; tested with a 10 μF ceramic and 470 μF polymer capacitor across the load.)						
Load Change from $I_O = 50\%$ to 75% of $I_{O, max}$: Peak Deviation	All	V_{pk}	—	750	—	mV_{pk}
Settling Time ($V_O < 10\%$ peak deviation)		t_s	—	800	—	μs
Load Change from $I_O = 75\%$ to 50% of $I_{O, max}$: Peak Deviation	All	V_{pk}	—	750	—	mV_{pk}
Settling Time ($V_O < 10\%$ peak deviation)		t_s	—	800	—	μs

General Specifications

Parameter	Device	Symbol	Typ	Unit
Calculated Reliability Based upon Telcordia SR-332 Issue 3: Method I, Case 3, ($I_O=80\%I_{O, max}$, $T_A=40^\circ\text{C}$, Airflow = 200 LFM), 90% confidence	All	MTBF	10,397,655	Hours
	All	FIT	96.2	$10^9/\text{Hours}$
Weight – with Base plate option		—	69.2 (2.44)	g (oz.)

Isolation Specifications

Parameter	Symbol	Min	Typ	Max	Unit
Isolation Capacitance	C_{iso}	—	2000	—	pF
Isolation Resistance	R_{iso}	10	—	—	M Ω

Technical Specifications (continued)

Feature Specifications

Unless otherwise indicated, specifications apply over all operating input voltage, resistive load, and temperature conditions. See Feature Descriptions for additional information.

Parameter	Device	Symbol	Min	Typ	Max	Unit
Remote On/Off Signal Interface ($V_{IN}=V_{IN, min}$ to $V_{IN, max}$, Signal referenced to V_{IN-} terminal) Negative Logic: device code suffix "1" Logic Low = module On, Logic High = module Off Positive Logic: No device code suffix required Logic Low = module Off, Logic High = module On Logic Low Specification						
On/Off Thresholds:						
Remote On/Off Current – Logic Low	All	$I_{on/off}$	280	—	310	μA
Logic Low Voltage	All	$V_{on/off}$	-0.3	—	0.8	V_{dc}
Logic High Voltage – (Typ = Open Collector)	All	$V_{on/off}$	2.0	—	14.5	V_{dc}
Logic High maximum allowable leakage current ($V_{on/off} = 2.0V$)	All	$I_{on/off}$	—	—	10	μA
Maximum voltage allowed on On/Off pin	All	$V_{on/off}$	—	—	14.5	V_{dc}
Turn-on Delay and Rise Time ($I_o=I_{o, max}$) T_{delay} =Time until $V_o = 10\%$ of $V_{o,set}$ from either application of V_{in} with Remote On/Off set to On (Enable with V_{in}); or operation of Remote On/Off from Off to On with V_{in} already applied for at least 150 milli-seconds (Enable with on/off). * Increased T_{delay} due to startup for parallel modules.	All w/o -P All w/o -P w/ -P w/ -P	$T_{delay, Enable with V_{in}}$ $T_{delay, Enable with on/off}$ $T_{delay, Enable with V_{in}}$ $T_{delay, Enable with on/off}$	— — — —	— — — —	150 10 180* 40*	ms ms ms ms
T_{rise} =Time for V_o to rise from 10% to 90% of $V_{o,set}$, For $C_o > 5000\mu F$, I_o must be $< 50\% I_{o, max}$ during T_{rise} . * Increased T_{rise} when V_o exists at startup for parallel modules.	All w/o -P w/ -P	T_{rise} T_{rise}		— —	25 50*	ms ms
Load Sharing Current Balance (difference in output current across all modules without outputs in parallel, no load to full load)	-P Option	I_{diff}			3	A
Output Voltage Adjustment range	All w/ "9" option	$V_{o, set}$	6.0		13.2	V_{dc}
Remote Sense Range	All w/ "9" option	V_{sense}	—	—	0.5	V_{dc}
Output Overvoltage Protection Setpoint	All	$V_{o, OVPset}$	$V_{o, SET} + 3.99V$			V_{dc}
Output Voltage Peak Limits prior to OVP Protection, (100%-0% load dump, $C_o=C_{o, min}$ all V_{IN} , I_o) ($6.0V \leq V_{o, SET} \leq 12.0V$) ($12.01V \leq V_{o, SET} \leq 13.2V$)	All All	$V_{o, limit}$ $V_{o, limit}$	$V_{o, OVPset} - 0.5V$ 15.49	— —	$V_{o, OVPset} + 2.0V$ 17.99V	V_{dc} V_{dc}
Overtemperature Protection (See Feature Descriptions)	All	T_{ref}	—	135	—	$^{\circ}C$
Input Undervoltage Lockout Turn-on Threshold Turn-off Threshold			— 31	35 33	36 —	V_{dc} V_{dc}
Input Overvoltage Lockout Turn-off Threshold Turn-on Threshold			— —	85 80	— —	V_{dc} V_{dc}

Technical Specifications (continued)

Characteristic Curves

The following figures provide typical characteristics for the QSVW042A0B (12V, 42A) at 25°C. The figures are identical for either positive or negative Remote On/Off logic.

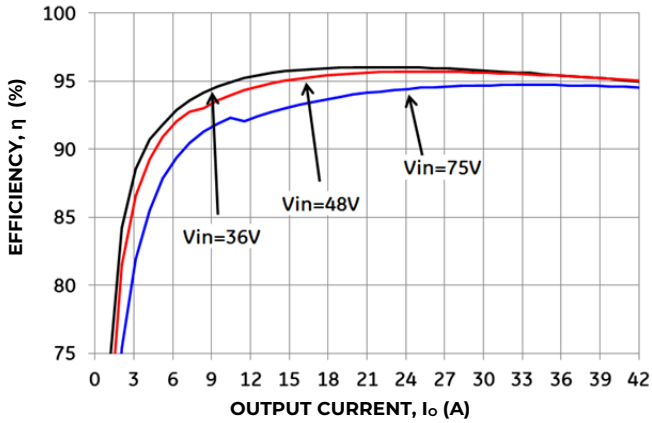

Figure 1. Typical Converter Efficiency vs. Output Current.

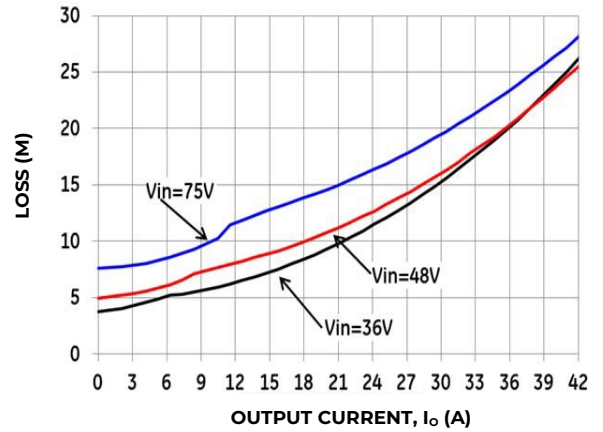

Figure 2. Typical Converter Loss vs. Output Current.

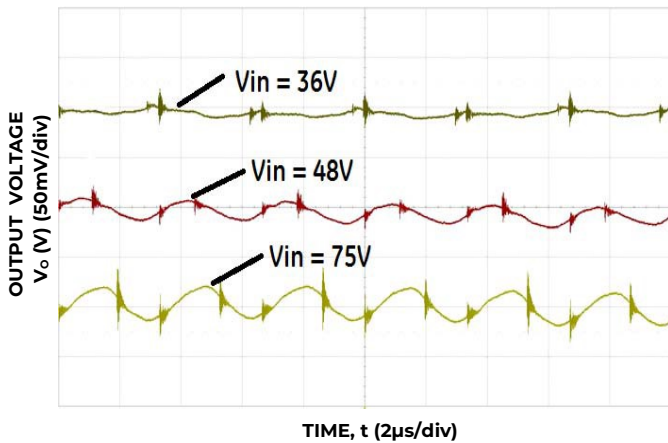

Figure 3. Typical Output Ripple and Noise, $I_o = I_{o,max}$, $C_o = C_{o,min}$

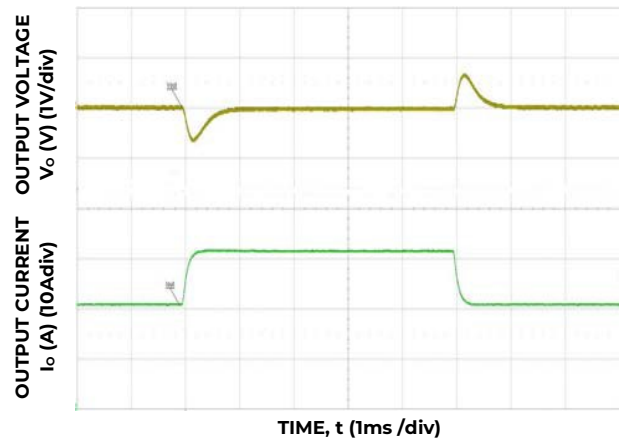

Figure 4. Typical Transient Response to 0.1A/µs Step Change in Load from 50% to 75% to 50% of Full Load, $C_o=470\mu F$ and 48 V_{dc} Input.

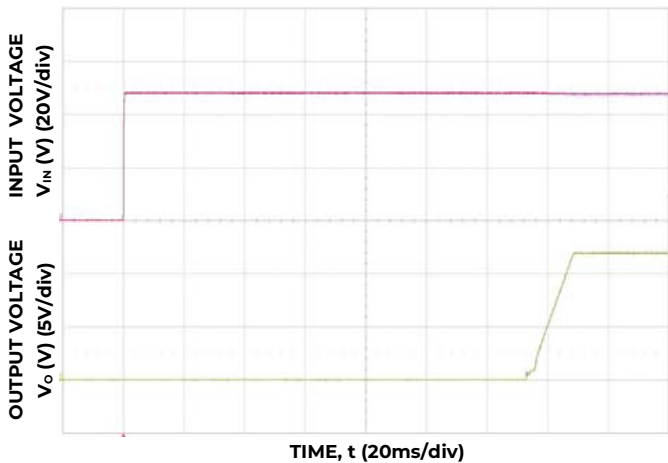

Figure 5. Typical Start-Up Using Vin with Remote On/Off enabled, negative logic version shown.

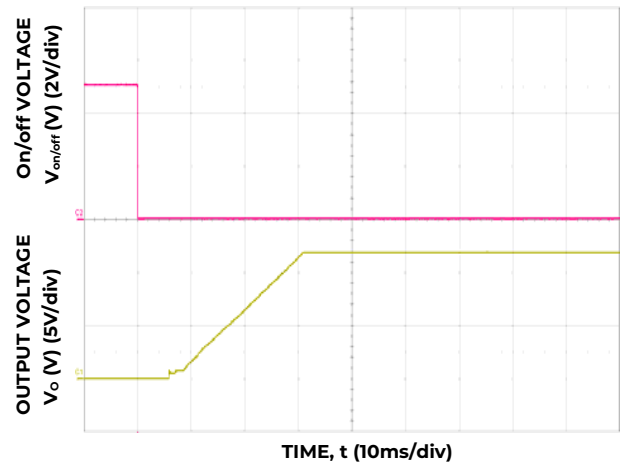

Figure 6. Typical Start-Up Using Remote On/Off with Vin applied, negative logic version shown

Technical Specifications (continued)

Characteristic Curves (continued)

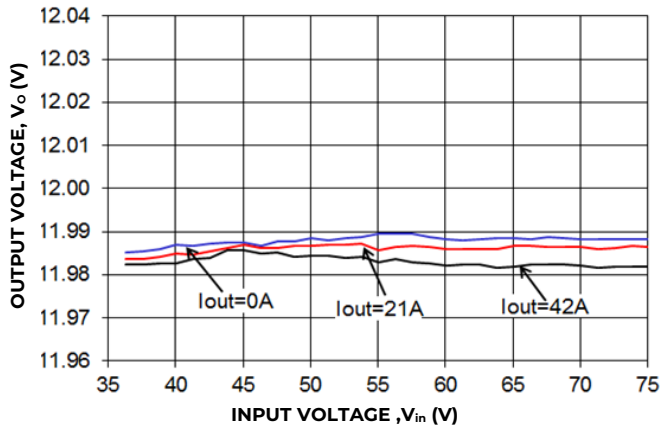

Figure 7. Typical Output Voltage Regulation vs. Input Voltage.

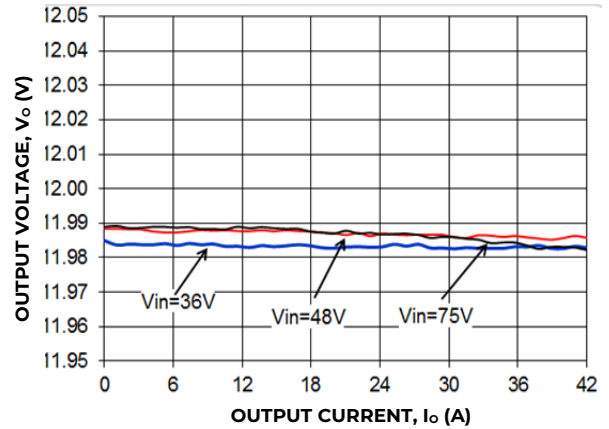

Figure 8. Typical Output Voltage Regulation vs. Output Current.

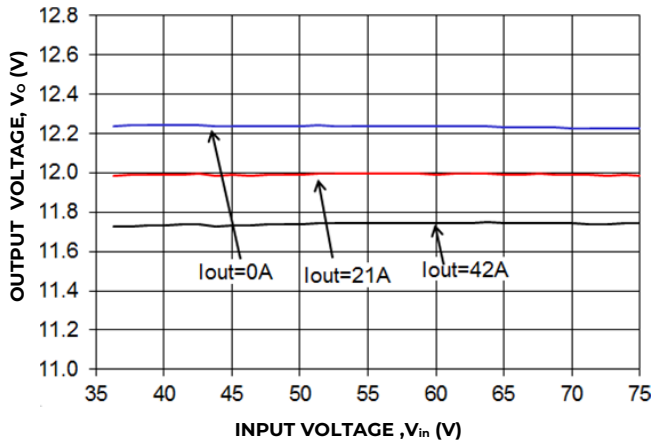

Figure 9. Typical Output Voltage Regulation vs. Input Voltage for the -P Version.

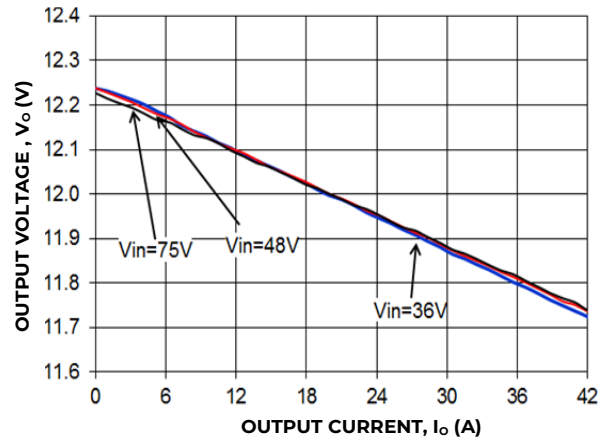
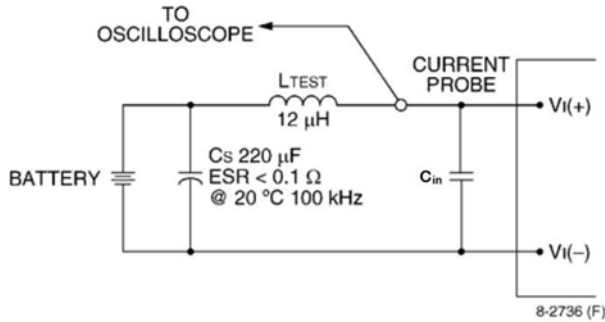

Figure 10. Typical Output Voltage Regulation vs. Output Current for the -P Version.

Technical Specifications (continued)

Test Configurations



Note: Measure input reflected-ripple current with a simulated source inductance (LTEST) of 12 μH. Capacitor CS offsets possible battery impedance. Measure current as shown above.

Figure 11. Input Reflected Ripple Current Test Setup.

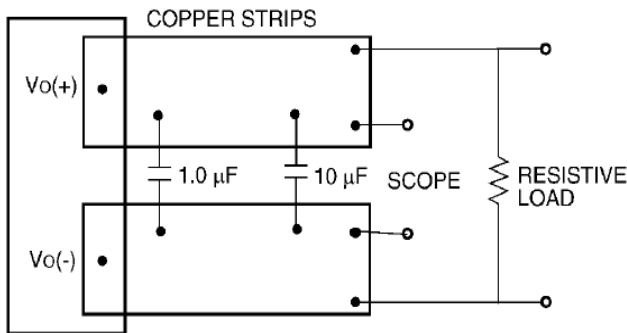

Note: Use a 1.0 μF ceramic capacitor, a 10 μF aluminum or tantalum capacitor. Scope measurement should be made using a BNC socket. Position the load between 51 mm and 76 mm (2 in. and 3 in.) from the module.

Figure 12. Output Ripple and Noise Test Setup.

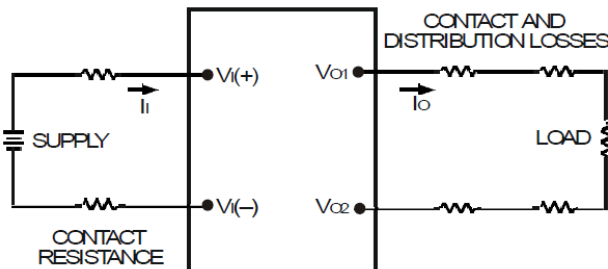

Note: All measurements are taken at the module terminals. When socketing, place Kelvin connections at module terminals to avoid measurement errors due to socket contact resistance.

$$\eta = \left(\frac{[V_o(+)-V_o(-)]I_o}{[V_i(+)-V_i(-)]I_i} \right) \times 100\%$$

Figure 13. Output Voltage and Efficiency Test Setup.

Design Considerations

Input Source Impedance

The power module should be connected to a low ac-impedance source. A highly inductive source impedance can affect the stability of the power module. For the test configuration in Figure 11, a 220μF electrolytic capacitor, Cin, (ESR<0.7Ω at 100kHz), mounted close to the power module helps ensure the stability of the unit. If the module is subjected to rapid on/off cycles, a 330μF input capacitor is required. Consult the factory for further application guidelines.

Safety Considerations

For safety agency approval the power module must be installed in compliance with the spacing and separation requirements of the end-use safety agency standards, i.e., UL ANSI/UL* 62368-1 and CAN/CSA+ C22.2 No. 62368-1 Recognized, DIN VDE 0868-1/ A11:2017 (EN62368-1:2014/A11:2017)

If the input source is non-SELV (ELV or a hazardous voltage greater than 60 Vdc and less than or equal to 75Vdc), for the module’s output to be considered as meeting the requirements for safety extra-low voltage (SELV), all of the following must be true:

- The input source is to be provided with reinforced insulation from any other hazardous voltages, including the ac mains.
- One VIN pin and one VOUT pin are to be grounded, or both the input and output pins are to be kept floating.
- The input pins of the module are not operator accessible.
- Another SELV reliability test is conducted on the whole system (combination of supply source and subject module), as required by the safety agencies, to verify that under a single fault, hazardous voltages do not appear at the module’s output.

Note: Do not ground either of the input pins of the module without grounding one of the output pins. This may allow a non-SELV voltage to appear between the output pins and ground.

The power module has safety extra-low voltage (SELV) outputs when all inputs are SELV.

The input to these units is to be provided with a maximum 25A fast-acting (or time-delay) fuse in the ungrounded input lead.

The power module has internally generated voltages exceeding safety extra-low voltage. Consideration should be taken to restrict operator accessibility.

Technical Specifications (continued)

Feature Descriptions

Overcurrent Protection

To provide protection in a fault output overload condition, the module is equipped with internal current-limiting circuitry and can endure current limiting continuously. If the overcurrent condition causes the output voltage to fall greater than 4.0V from $V_{o, set}$, the module will shut down and remain latched off. The overcurrent latch is reset by either cycling the input power or by toggling the on/off pin for one second. If the output overload condition still exists when the module restarts, it will shut down again. This operation will continue indefinitely until the overcurrent condition is corrected.

A factory configured auto-restart option (with overcurrent and overvoltage auto-restart managed as a group) is also available. An auto-restart feature continually attempts to restore the operation until fault condition is cleared.

Output Overvoltage Protection

The module contains circuitry to detect and respond to output overvoltage conditions. If the overvoltage condition causes the output voltage to rise above the limit in the Specifications Table, the module will shut down. The QSVW042A0B module is factory default configured for auto-restart operation. The auto-restart feature continually attempts to restore the operation until fault condition is cleared. If the output overvoltage condition still exists when the module restarts, it will shut down again. This operation will continue indefinitely until the overvoltage condition is corrected.

A factory configured auto-restart option (with overcurrent and overvoltage auto-restart managed as a group) is also available. An auto-restart feature continually attempts to restore the operation until fault condition is cleared.

Overtemperature Protection

The modules feature an overtemperature protection circuit to safeguard against thermal damage. The circuit shuts down the module when the default maximum device reference temperature is exceeded. The module is factory default configured to automatically restart once the reference temperature cools by $\sim 25^{\circ}\text{C}$.

Input Under/Over Voltage Lockout

At input voltages above or below the input under/over voltage lockout limits, module operation is disabled. The module will begin to operate when the input voltage level changes to within the under and overvoltage lockout limits.

Remote On/Off

The module contains a standard on/off control circuit reference to the $V_{IN(-)}$ terminal. Two factory configured remote on/off logic options are available. Positive logic remote on/off turns the module on during a logic-high voltage on the ON/OFF pin, and off during a logic LO. Negative logic remote on/off turns the module off during a logic HI, and on during a logic LO. Negative logic, device code suffix "1," is the factory-preferred configuration. The On/Off circuit is powered from an internal bias supply, derived from the input voltage terminals. To turn the power module on and off, the user must supply a switch to control the voltage between the On/Off terminal and the $V_{IN(-)}$ terminal ($V_{on/off}$). The switch can be an open collector or equivalent (see Figure 14). A logic LO is $V_{on/off} = -0.3\text{V}$ to 0.8V . The typical $I_{on/off}$ during a logic LO ($V_{in}=48\text{V}$, On/Off Terminal= 0.3V) is $147\mu\text{A}$. The switch should maintain a logic-low voltage while sinking $310\mu\text{A}$. During a logic HI, the maximum $V_{on/off}$ generated by the power module is 8.2V . The maximum allowable leakage current of the switch at $V_{on/off} = 2.0\text{V}$ is $10\mu\text{A}$. If using an external voltage source, the maximum voltage $V_{on/off}$ on the pin is 14.5V with respect to the $V_{IN(-)}$ terminal.

If not using the remote on/off feature, perform one of the following to turn the unit on:

For negative logic: short ON/OFF pin to $V_{IN(-)}$.

For positive logic: leave ON/OFF pin open.

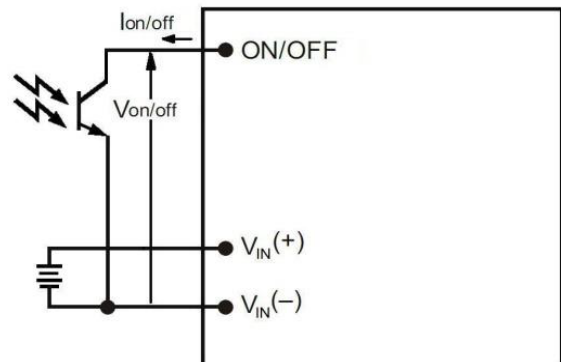

Figure 14. Remote On/Off Implementation.

Load Sharing

For higher power requirements, the QBVE094A0S10R7 power module offers an optional feature for parallel operation (-P Option code). This feature provides a precise forced output voltage load regulation droop characteristic. The output set point and droop slope are factory calibrated to insure optimum matching of multiple modules' load regulation characteristics. To implement load sharing, the following requirements should be followed:

Technical Specifications (continued)

- The $V_{OUT}(+)$ and $V_{OUT}(-)$ pins of all parallel modules must be connected together. Balance the trace resistance for each module's path to the output power planes, to insure best load sharing and operating temperature balance.
- V_{IN} must remain between $36V_{dc}$ and $75V_{dc}$ for droop sharing to be functional.
- It is permissible to use a common Remote On/Off signal to start all modules in parallel.
- These modules contain means to block reverse current flow upon start-up, when output voltage is present from other parallel modules, thus eliminating the requirement for external output ORing devices. Modules with the -P option will self-determine the presence of voltage on the output from other operating modules, and automatically increase its Turn On delay, T_{delay} , as specified in the Feature Specifications Table.
- When parallel modules startup into a pre-biased output, e.g. partially discharged output capacitance, the T_{rise} is automatically increased, as specified in the Feature Specifications table, to insure graceful startup.
- Insure that the load is $<50\% I_{O,MAX}$ (for a single module) until all parallel modules have started (load full start $>$ module T_{delay} time max + T_{rise} time).
- If fault tolerance is desired in parallel applications, output ORing devices should be used to prevent a single module failure from collapsing the load bus.

Remote Sense ("9" Option Code)

Remote sense minimizes the effects of distribution losses by regulating the voltage at the remote-sense connections (See Figure15). The SENSE(-) pin should be always connected to $V_o(-)$. The voltage between the remote-sense pins and the output terminals must not exceed the output voltage sense range given in the Feature Specifications table:

$$[V_{O(+)} - V_{O(-)}] - [SENSE(+)] \leq 0.5 V$$

Although the output voltage can be increased by both the remote sense and by the trim, the maximum increase for the output voltage is not the sum of both. The maximum increase is the larger of either the remote sense or the trim. The amount of power delivered by the module is defined as the voltage at the output terminals multiplied by the output current. When using remote sense and trim, the output voltage of the module can be increased, which at the same output current, would increase the power output of the module. Care should be taken to ensure that the maximum output power of the module remains at or below the maximum rated power

(Maximum rated power = $V_{o,set} \times I_{o,max}$)

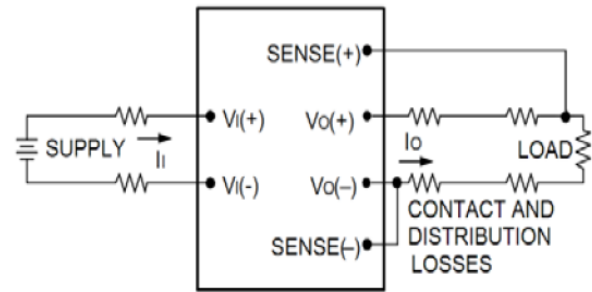

Figure 15. Circuit Configuration for Remote Sense.

Trim, Output Voltage Programming

Trimming allows the output voltage set point to be increased or decreased; this is accomplished by connecting an external resistor between the TRIM pin and either the $V_o(+)$ pin or the $V_o(-)$ pin.

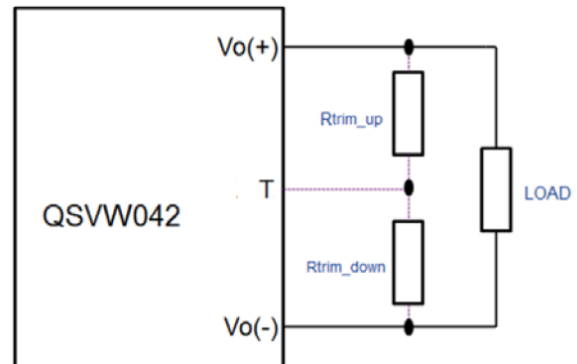

Figure 16. Circuit Configuration to Trim Output Voltage.

Connecting an external resistor ($R_{trim-down}$) between the T pin and the $V_o(-)$ (or Sense(-)) pin decreases the output voltage set point. To maintain set point accuracy, the trim resistor tolerance should be $\pm 1.0\%$.

The following equation determines the required external resistor value to obtain a percentage output voltage change of $\Delta\%$.

$$R_{trim-down} = \left[\frac{511}{\Delta\%} - 10.22 \right] K\Omega$$

Where

$$\Delta\% = \left(\frac{12.0V - V_{desired}}{12.0V} \right) \times 100$$

Technical Specifications (continued)

Trim, Output Voltage Programming (continued)

For example, to trim-down the output voltage of the module by 20% to 9.6V, $R_{trim-down}$ is calculated as follows:

$$\Delta\% = 20$$

$$R_{trim-down} = \left[\frac{511}{\Delta\%} - 10.22 \right] K\Omega$$

$$R_{trim-down} = 15.3 K\Omega$$

Connecting an external resistor ($R_{trim-up}$) between the T pin and the $V_o(+)$ (or Sense (+)) pin increases the output voltage set point. The following equations determine the required external resistor value to obtain a percentage output voltage change of $\Delta\%$:

$$R_{trim-up} = \left[\frac{5.11 \times 12.0V \times (100 + \Delta\%)}{1.225 \times \Delta\%} - \frac{511}{\Delta\%} - 10.22 \right] K\Omega$$

Where $\Delta\% = \left(\frac{V_{desired} - 12.0V}{12.0V} \right) \times 100$

For example, to trim-up the output voltage of the module by 5% to 12.6V, $R_{trim-up}$ is calculated as follows:

$$\Delta\% = 5$$

$$R_{trim-up} = \left[\frac{5.11 \times 12.0V \times (100 + 5)}{1.225 \times 5} - \frac{511}{5} - 10.22 \right] K\Omega$$

$$R_{trim-up} = 938.8 K\Omega$$

The voltage between the $V_o(+)$ and $V_o(-)$ terminals must not exceed the minimum output overvoltage protection value shown in the Feature Specifications table. This limit includes any increase in voltage due to remote-sense compensation and output voltage set-point adjustment trim.

Although the output voltage can be increased by both the remote sense and by the trim, the maximum increase for the output voltage is not the sum of both. The maximum increase is the larger of either the remote sense or the trim. The amount of power delivered by the module is defined as the voltage at the output terminals multiplied by the output current. When using remote sense and trim, the output voltage of the module can be increased, which at the same output current would increase the power output of the module. Care should be taken to ensure that the maximum output power of the module remains at or below the maximum rated power (Maximum rated power = $V_{o,set} \times I_{o,max}$).

Thermal Considerations

The thermal data presented here is based on physical measurements taken in a wind tunnel, using automated thermo-couple instrumentation to monitor key component temperatures: FETs, diodes, control ICs, magnetic cores, ceramic capacitors, opto-isolators, and module pwb conductors, while controlling the ambient airflow rate and temperature. For a given airflow and ambient temperature, the module output power is increased, until one (or more) of the components reaches its maximum derated operating temperature, as defined in IPC-9592B. This procedure is then repeated for a different airflow or ambient temperature until a family of module output derating curves is obtained.

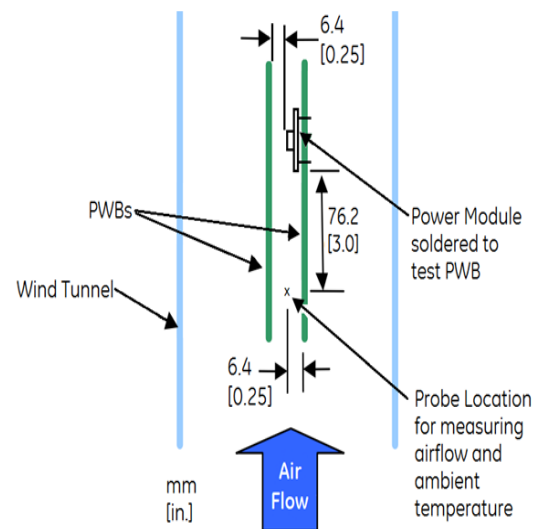

The power modules operate in a variety of thermal environments and sufficient cooling should be provided to help ensure reliable operation. Thermal considerations include ambient temperature, airflow, module power dissipation, and the need for increased reliability. A reduction in the operating temperature of the module will result in an increase in reliability.

Heat-dissipating components are mounted on the top side of the module. Heat is removed by conduction, convection and radiation to the surrounding environment. Proper cooling can be verified by measuring the thermal reference temperature (TH_1 or TH_2). Peak temperature occurs at the position indicated in Figure 17. For reliable operation this temperature should not exceed $TREF1=100^\circ C$ or $TREF2=100^\circ C$. For extremely high reliability you can limit this temperature to a lower value.

Technical Specifications (continued)

Thermal Considerations (continued)

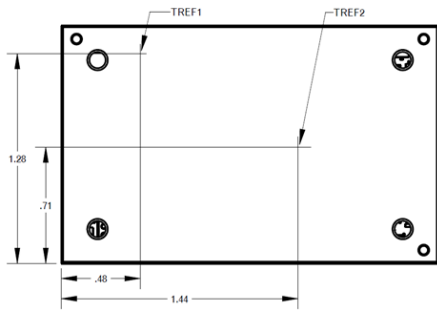

Figure 17. Location of the thermal reference temperature T_{REF1} and T_{REF2} for Baseplate module.

The output power of the module should not exceed the rated power for the module as listed in the Ordering Information table.

Please refer to the Application Note “Thermal Characterization Process For Open-Frame Board-Mounted Power Modules” for a detailed discussion of thermal aspects including maximum device temperatures.

Heat Transfer via Convection

Increased airflow over the module enhances the heat transfer via convection. The thermal derating of figure 18-21 shows the maximum output current that can be delivered by each module in the indicated orientation without exceeding the maximum T_{REFx} temperature versus local ambient temperature (T_A) for several air flow conditions. The use of Figure 19 is shown in the following example:

Example

What is the minimum airflow required for a QSVW042A0B-H operating at $V_I = 48\text{ V}$, an output current of 31A, and ambient temperature of 65°C in transverse orientation.

Solution:

Given: $V_{in} = 48\text{ V}$, $I_o = 31\text{ A}$, $T_A = 65^\circ\text{C}$

Determine required airflow velocity (Use Figure 19):

Velocity = 0.5m/s (100 LFM) or greater.

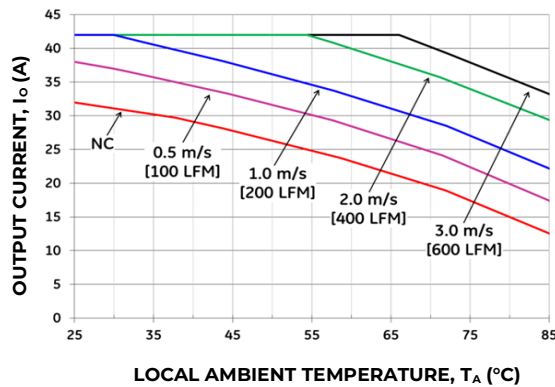

Figure 18. Output Current Derating for the Base plate QSVW042A0B-H in the Transverse Orientation; Airflow Direction from $V_{in}(-)$ to $V_{in}(+)$; $V_{in} = 48\text{ V}$.

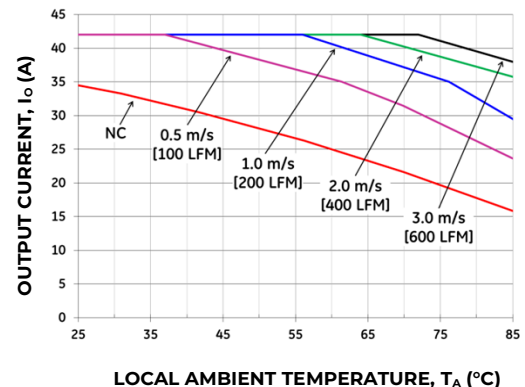

Figure 19. Output Current Derating for the Base plate QSVW042A0B-H +0.5" Heat sink in the Transverse Orientation; Airflow Direction from $V_{in}(-)$ to $V_{in}(+)$; $V_{in} = 48\text{ V}$.

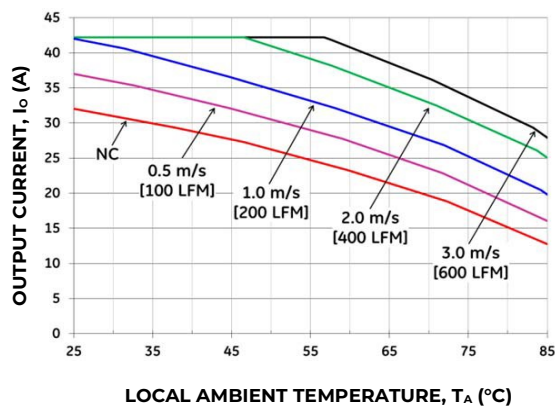

Figure 20. Output Current Derating for the Base plate QSVW042A0B-H in the Longitudinal Orientation; Airflow Direction from V_{out} to V_{in} ; $V_{in} = 48\text{ V}$.

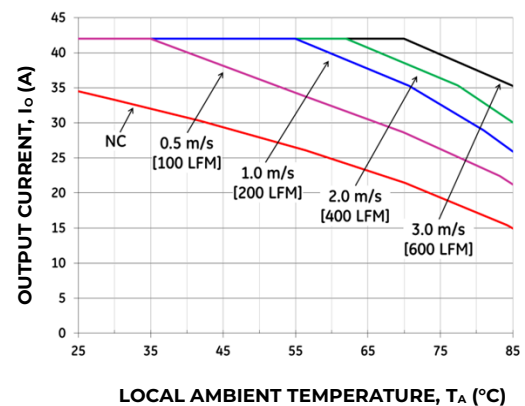

Figure 21. Output Current Derating for the Base plate QSVW042A0B-H +0.5" Heat sink in the Longitudinal Orientation; Airflow Direction from V_{out} to V_{in} ; $V_{in} = 48\text{ V}$.

Technical Specifications (continued)

Layout Considerations

The QSVW042A0B power module series are low profile in order to be used in fine pitch system card architectures. As such, component clearance between the bottom of the power module and the mounting board is limited. Avoid placing copper areas on the outer layer directly underneath the power module. Also avoid placing via interconnects underneath the power module.

For additional layout guide-lines, refer to FLTR100V10 Data Sheet.

Through-Hole Lead-Free Soldering Information

The RoHS-compliant, Z version, through-hole products use the SAC (Sn/Ag/Cu) Pb-free solder and RoHS-compliant components. The non-Z version products use lead-tin (Pb/Sn) solder and RoHS-compliant components. Both version modules are designed to be processed through single or dual wave soldering machines. The pins have an RoHS-compliant, pure tin finish that is compatible with both Pb and Pb-free wave soldering processes. A maximum preheat rate of 3°C/s is suggested. The wave preheat process should be such that the temperature of the power module board is kept below 210°C. For Pb solder, the recommended pot temperature is 260°C, while the Pb-free solder pot is 270°C max. Not all RoHS-compliant through-hole products can be processed with paste-through-hole Pb or Pb-free reflow process. If additional information is needed, please consult with your OmniOn representative for more details.

Reflow Lead-Free Soldering Information

The RoHS-compliant through-hole products can be processed with the following paste-through-hole Pb or Pb-free reflow process.

Max. sustain temperature :

245°C (J-STD-020C Table 4-2: Packaging Thickness \geq 2.5mm/ Volume $>$ 2000mm³),

Peak temperature over 245°C is not suggested due to the potential reliability risk of components under continuous high-temperature.

Min. sustain duration above 217°C : 90 seconds Min.
sustain duration above 180°C : 150 seconds Max. heat up rate: 3°C/sec

Max. cool down rate: 4°C/sec

In compliance with JEDEC J-STD-020C spec for 2 times reflow requirement.

Pb-free Reflow Profile

BMP module will comply with J-STD-020 Rev. C (Moisture/Reflow Sensitivity Classification for Nonhermetic Solid State Surface Mount Devices) for

both Pb-free solder profiles and MSL classification procedures. BMP will comply with JEDEC J-STD-020C specification for 3 times reflow requirement. The suggested Pb-free solder paste is Sn/Ag/Cu (SAC). The recommended linear reflow profile using Sn/Ag/Cu solder is shown in Figure 22.

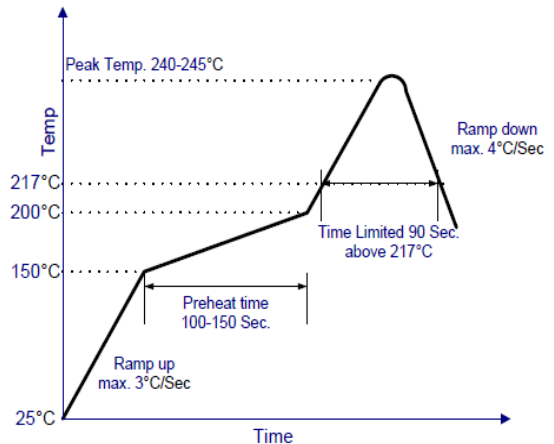

Figure 22. Recommended linear reflow profile using Sn/Ag/Cu solder

MSL Rating

The QSVW042A0B modules have a MSL rating of 2a.

Storage and Handling

The recommended storage environment and handling procedures for moisture-sensitive surface mount packages is detailed in J-STD-033 Rev. A (Handling, Packing, Shipping and Use of Moisture/Reflow Sensitive Surface Mount Devices). Moisture barrier bags (MBB) with desiccant are required for MSL ratings of 2 or greater. These sealed packages should not be broken until time of use. Once the original package is broken, the floor life of the product at conditions of \leq 30°C and 60% relative humidity varies according to the MSL rating (see J-STD-033A). The shelf life for dry packed SMT packages will be a minimum of 12 months from the bag seal date, when stored at the following conditions: $<$ 40°C, $<$ 90% relative humidity.

Post Solder Cleaning and Drying Considerations

Post solder cleaning is usually the final circuit-board assembly process prior to electrical board testing. The result of inadequate cleaning and drying can affect both the reliability of a power module and the testability of the finished circuit-board assembly. For guidance on appropriate soldering, cleaning and drying procedures, refer to OmniOn Board Mounted Power Modules: Soldering and Cleaning Application Note (AP01-056EPS).

Technical Specifications (continued)

EMC Considerations

The circuit and plots in Figure 23 show a suggested configuration to meet the conducted emission limits of EN55032 Class A. For further information on designing for EMC compliance, please refer to the FLT012A0Z data sheet.

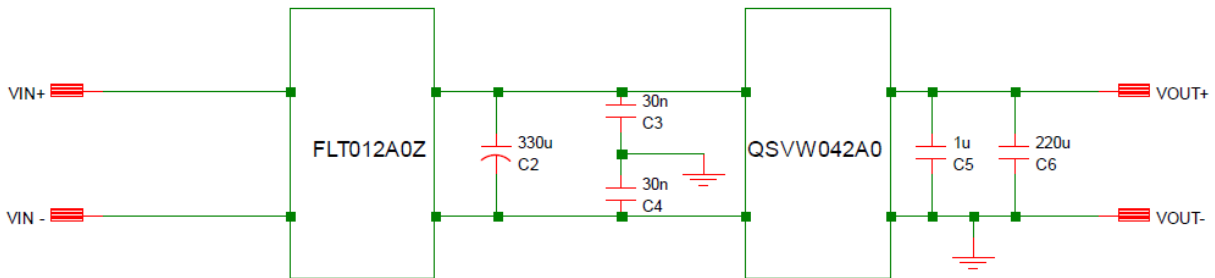

- C2 = 330µF 100V Nichicon VR series
- C3 & C4 = 3 X 0.01µF High Voltage Capacitors
- C5 = 1µF 16V 1210
- C6 = 220µF, 16V, KME Nichicon series

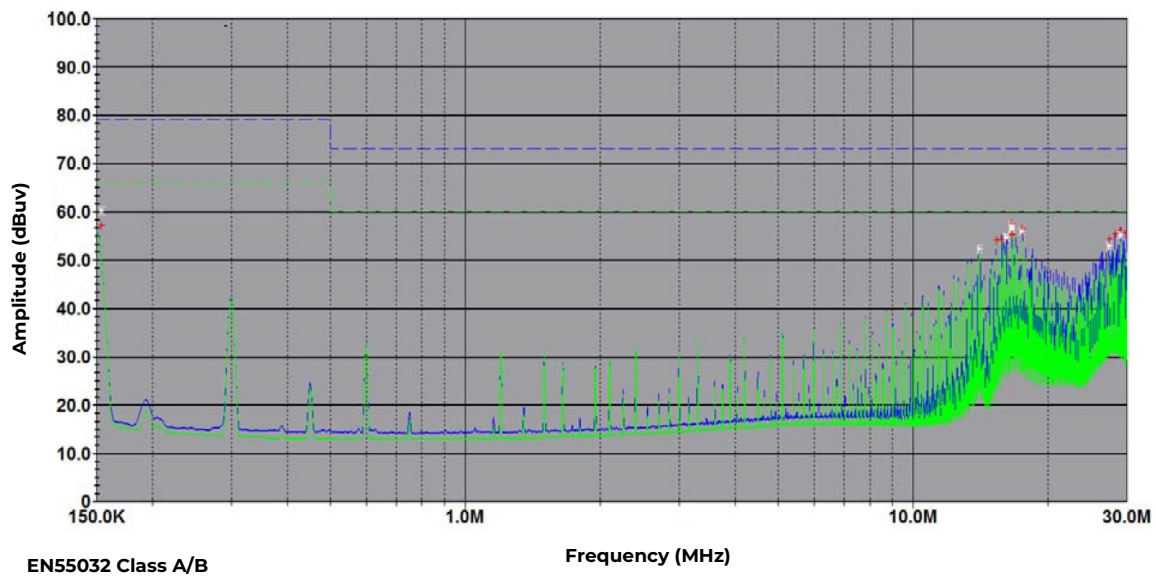

Figure 23. EMC Consideration

Technical Specifications (continued)

Packaging Details

All versions of the QSVW042A0B are supplied as standard in the plastic trays shown in Figure 24. Each tray contains a total of 12 power modules. The trays are self-stacking and each shipping box for the QSVW042A0B module contains 2 full trays plus one empty hold-down tray giving a total number of 24 power modules.

Tray Specification

Material	PET (1mm)
Max surface resistivity	$10^9 - 10^{11} \Omega/\text{PET}$
Color	Clear
Capacity	12 power modules
Min order quantity	24 pcs (1 box of 2 full trays + 1 empty top tray)

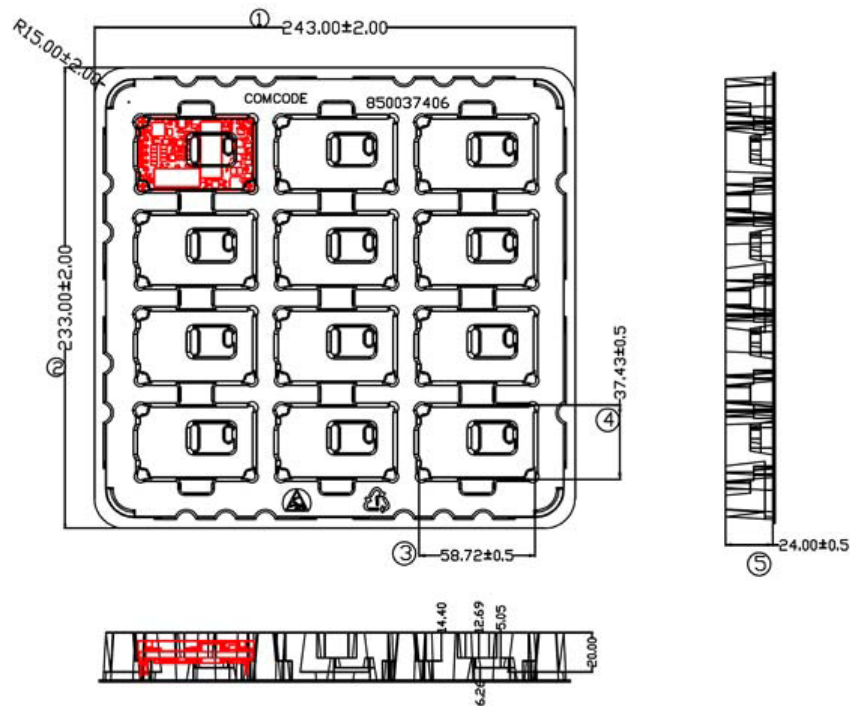

Base Plate Module Tray

Figure 24. QSVW042 Packaging Tray

Technical Specifications (continued)

Mechanical Outline for QBVE094A0S10R7-xH (Base plate) Through-hole Module

Dimensions are in millimeters and (inches).

Tolerances: x.x mm ± 0.5 mm (x.xx in. ± 0.02 in.) [unless otherwise indicated]

x.xx mm ±0.25 mm (x.xxx in ± 0.010 in.)

TOP VIEW

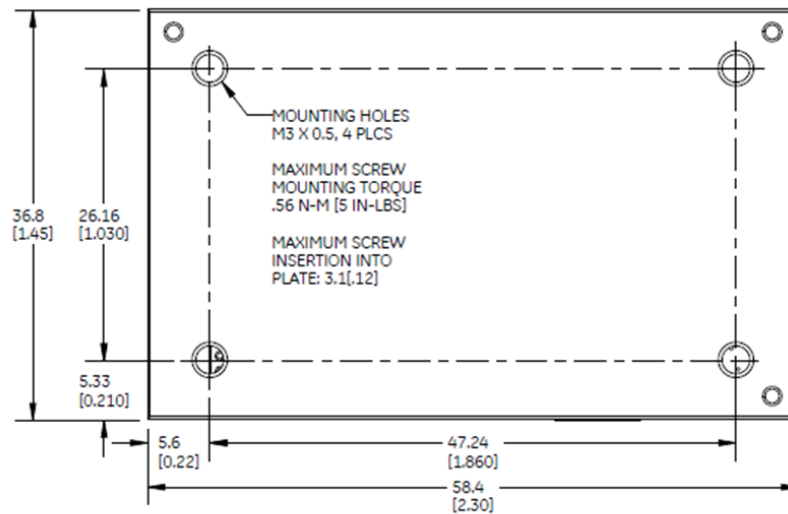

SIDE VIEWS

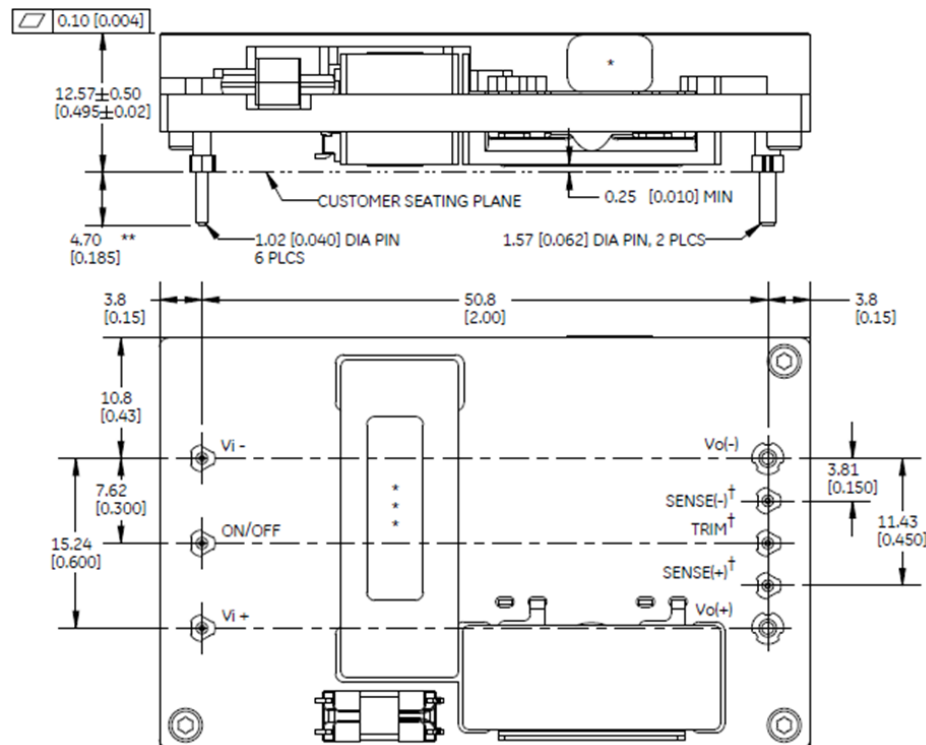

BOTTOM VIEW*

Pin Number	Pin Name
1	V _{IN} (+)
2	ON/OFF
3	V _{IN} (-)
4	V _{OUT} (-)
5 [†]	SENSE
6 [†]	TRIM
7 [†]	SENSE
8	V _{OUT} (+)

[†] -"9" Option

* Bottom side label includes OmniOn name, product designation, and data code.

** Standard pin tail length. Optional pin tail lengths shown in Table 2, Device Options.

Technical Specifications (continued)

Recommended Pad Layout

Dimensions are in millimeters and (inches).

Tolerances: x.x mm ± 0.5 mm (x.xx in. ± 0.02 in.) [unless otherwise indicated]

x.xx mm ± 0.25 mm (x.xxx in ± 0.010 in.)

Through-Hole Modules

Pin Number	Pin Name
1	V _{IN} (+)
2	ON/OFF
3	V _{IN} (-)
4	V _{OUT} (-)
5†	SENSE
6†	TRIM
7†	SENSE
8	V _{OUT} (+)

† -"9" Option

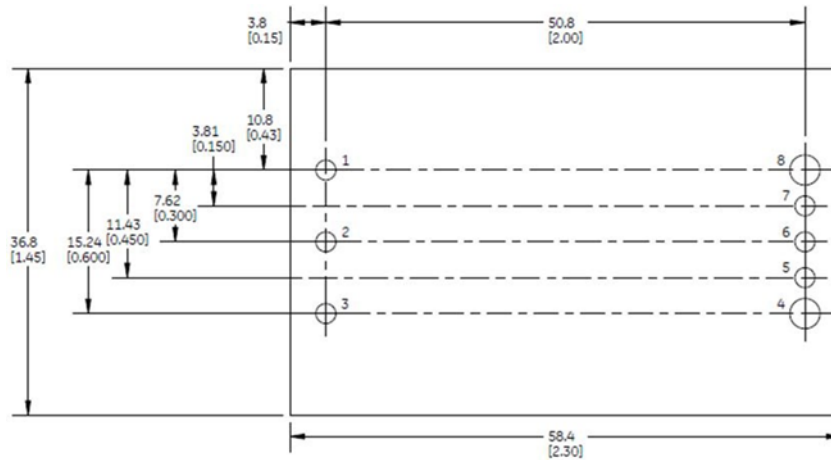

Hole and Pad diameter recommendations:

Pin Number	Hole Dia mm [in]	Pad Dia mm [in]
1, 2, 3, 5, 6, 7	1.6 [.063]	2.1 [.083]
4, 8	2.2 [.087]	3.2 [.126]

Ordering Information

Please contact your OmniOn Sales Representative for pricing, availability and optional features.

Product codes	Input Voltage	Output Voltage	Output Current	On/Off logic	Efficiency	Connector Type	MSL Rating	Ordering Codes
QSVW042A0B41-HZ	48V (36 -75Vdc)	12V	42A	Negative	95%	Through Hole	2a	150039419
QSVW042A0B641- HZ	48V (36 -75Vdc)	12V	42A	Negative	95%	Through Hole	2a	150042781
QSVW042A0B9641- HZ	48V (36 -75Vdc)	12V	42A	Negative	95%	Through Hole	2a	150048677

Table 1. Device Codes

Technical Specifications (continued)

Characteristic		Character and Position										Definition				
Ratings	Form Factor	Q											Q = Quarter Brick			
	Family Designator		SV										SV= BARRACUDA Series without PMBus Interface			
	Input Voltage			W									W=Wide Range,48/52/54v (36V-75V)			
	Output Power				042	A0							042A0= 042.0 Amps Maximum Output Current			
	Output Voltage						B						B= 12.0V nominal			
Options	Trim and Remote Sense Pins					9							Omit = Exclude Trim & Sense Pins 9= Include Trim and Sense Pins			
	Pin Length						8						Omit = Default Pin Length shown in Mechanical Outline Figures 8 = Pin Length: 2.79 mm ± 0.25mm , (0.110 in. ± 0.010 in.) 6 = Pin Length: 3.68 mm ± 0.25mm , (0.145 in. ± 0.010 in.)			
	Action following Protective Shutdown							4					Omit = Latching Mode 4 = Auto-restart following shutdown (Overcurrent/Overvoltage)			
	On/Off Logic								1				Omit = Positive Logic 1 = Negative Logic			
											-					
	Customer Specific											X Y	XY= Customer Specific Modified Code, Omit for Standard Code			
	Maximum Output Cap												Q	Q= Increased Maximum External Output Capacitance		
	Load Share													P	P= Forced Droop Output for use in parallel applications	
	Features														H	H= Heat plate, for use with heat sinks or cold-walls (must be ordered)
	RoHS															Z

Table 2. Device Options

Contact Us

For more information, call us at

+1-877-546-3243 (US)

+1-972-244-9288 (Int'l)

Change History (excludes grammar & clarifications)

Revision	Date	Description of the change
1.4	04/12/2022	Updated as per template , ROHS
1.5	12/08/2023	Updated as per OmniOn template

OmniOn Power Inc.

601 Shiloh Rd.
Plano, TX USA

omnionpower.com

We reserve the right to make technical changes or modify the contents of this document without prior notice. OmniOn Power does not accept any responsibility for errors or lack of information in this document and makes no warranty with respect to and assumes no liability as a result of any use of information in this document.

We reserve all rights in this document and in the subject matter and illustrations contained therein. Any reproduction, disclosure to third parties or utilization of its contents – in whole or in parts – is forbidden without prior written consent of OmniOn Power. This document does not convey license to any patent or any intellectual property right. Copyright© 2023 OmniOn Power Inc. All rights reserved.