

QODE136A0B: Osprey* Series DC-DC Converter

1600W Non-isolated, 40 to 60V_{DC} Input, 12V_{DC} 136A Output



RoHS Compliant



The OmniOn Power™ QODE Osprey™ series of dc-dc converters is a new generation of non-isolated, regulated DC/DC power modules designed to support 12V_{DC} intermediate bus applications. The QODE136A0B series operates from an input voltage range of 40 to 60V_{DC} and provide up to 1600W output power in an industry-standard, modified DOSA digital quarter brick. The converter incorporates digital control, synchronous rectification technology, a regulated control topology, and innovative packaging techniques to achieve full load efficiency exceeding 97% at 12V_{DC} output. Standard features include a heat plate to attach external heat sinks or contact a cold wall, on/off control, output overcurrent and over voltage protection, over temperature protection, input under and over voltage lockout and PMBus interface.

Application

- Servers and storage applications
- Supercomputers
- Distributed power architectures
- Intermediate bus voltage applications
- Networking equipment
- Automatic Test Equipment

Features

- Compliant to RoHS Directive 2011/65/EU and amended Directive (EU) 2015/863
- Compliant to REACH Directive (EC) No 1907/2006
- High and flat efficiency with peak efficiency 98%
- Input voltage range: 40-60V_{DC}
- Delivers up to 1600W output power
- Low output ripple and noise
- Industry standard, modified-DOSA Digital Quarter Brick: 58.4 mm x 36.8 mm x 14.5 mm (2.30 in x 1.45 in x 0.57 in)
- Constant switching frequency
- Remote On/Off control
- Output over current/voltage protection
- Digital interface with PMBus™ Rev.1.2 compliance
- Active current sharing
- Firmware update over I²C
- Black box
- Over temperature protection
- Pre-bias startup
- Wide operating temperature range: -40°C to 85°C, continuous
- ANSI/UL# 62368-1 and CAN/CSA+ C22.2 No. 62368-1 Recognized, TUV type approved:2017 (EN62368-1:2014/A11:2017)
- ISO** 9001 and ISO 14001 certified manufacturing facilities
- Base plate (-H option code)

QODE136A0B Technical Specifications

Absolute Maximum Ratings

Stresses in excess of the absolute maximum ratings can cause permanent damage to the device. These are absolute stress ratings only, functional operation of the device is not implied at these or any other conditions in excess of those given in the operations sections of the data sheet. Exposure to absolute maximum ratings for extended periods can adversely affect the device reliability.

Parameter	Symbol	Min	Max	Unit
Input Voltage ¹				
Continuous	V_{IN}	-0.3	65	V_{DC}
Transient (100ms)			80	
$V_{ON/OFF}$ to $V_{IN}(-)$	$V_{ON/OFF}$	-	14.5	V_{DC}
ADDR to $V_{OUT}(-)$		-0.5	3.3	V
Operating Ambient Temperature	T_A	-40	85	°C
Storage Temperature [limited by signal pins]	T_{stg}	-40	105	°C

¹Input over voltage protection will shutdown the output voltage when the input voltage exceeds threshold level.

²Base plate is considered floating.

Electrical Specifications

Unless otherwise indicated, specifications apply overall operating input voltage, resistive load, and temperature conditions.

Parameter	Device	Symbol	Min	Typ	Max	Unit
Operating Input Voltage	-H	V_{IN}	40	54	60	V_{DC}
Maximum Input Current ($V_{IN} = 54V$, $I_O = I_{O,max}$)		$I_{IN,max}$	-	-	35	A_{DC}
Input No Load Current ($V_{IN} = V_{IN,nom}$, $I_O = 0A$, module enabled)	All	$I_{IN,No\ load}$		200		mA
Input Stand-by Current ($V_{IN} = V_{IN,nom}$, module disabled)	All	$I_{IN,stand-by}$			30	mA
External Input Capacitance [to match Flex; Delta is 200]	All		220	-		μF
Input Terminal Ripple Current (Measured at module input pin with 220 μF input capacitance and < 500 μH inductance between voltage source and input capacitance) 5Hz to 20MHz, $V_{IN} = 48V$, $I_O = I_{O,max}$	All		-		600	mA_{RMS}
Surge power (Tested with a 1.0 μF ceramic, and 5200 μF low ESR Polymer capacitor at the load) ($dI_O/dt = 1A/\mu s$; $T_A = 25^\circ C$; 2400w @ 3ms, period is 16ms)	All	P_O	-	-	2400	W
Input Ripple Rejection (120Hz)	All		-	25	-	dB
Output Voltage Set-point ($V_{IN} = 54V$, $I_O = \text{half-load}$, $T_A = 25^\circ C$)	All	$V_{O,set}$	11.95	12.0	12.05	V_{DC}
Output Voltage [Overall operating input voltage (40V to 60V), resistive load, and temperature conditions until end of life]	w/o - P w - P	V_O	11.8 11.6	12.0 12.0	12.2 12.4	V_{DC}
Output Voltage Programming Range	w/o - P	V_O	9.5		12.5	V_{DC}

Trademark of OmniOn Power Inc. All other trademarks belong to their respective owners.

* UL is a registered trademark of Underwriters Laboratories, Inc.

† CSA is a registered trademark of Canadian Standards Association.

** ISO is a registered trademark of the International Organization of Standards.

#The PMBus name and logo are registered trademarks of the System Management Interface Forum (SMIF)

QODE136A0B Technical Specifications (continued)

Electrical Specifications (continued)

Parameter	Device	Symbol	Min	Typ	Max	Unit
Output Regulation ($V_{IN, min} = 40V$)						
Line ($V_{IN} = V_{IN, min}$ to $V_{IN, max}$)	All		-	0.8	-	% $V_{O, set}$
Load ($I_O = I_{O, min}$ to $I_{O, max}$)	w/o -P		-	0.5	-	% $V_{O, set}$
Load ($I_O = I_{O, min}$ to $I_{O, max}$), internal droop	-P Option		-	0.4	-	V_{DC}
Temperature ($T_A = -40^{\circ}C$ to $+85^{\circ}C$)	All		-	2	-	% $V_{O, set}$
Output Ripple and Noise, $C_O = 4000 \mu F$, $\frac{1}{2}$ Ceramic, $\frac{1}{2}$ PosCap or Oscon ($V_{IN} = V_{IN, nom}$ and $I_O = I_{O, min}$ to $I_{O, max}$)	All					
RMS (5Hz to 20MHz bandwidth)			-	50	-	mV _{RMS}
Peak-to-Peak (5Hz to 20MHz bandwidth)			-	-	150	mV _{pk-pk}
External Output Capacitance (50% ceramic, 50% Oscon or POSCAP) [matches Flex, Delta]	All	C_O	4000	-	30000	μF
Output Power, continuous, 40-60 V_{IN}	All	P_O	0	-	1600	W
Output Current for 3ms					2400	
Output Current	All	I_O	0	-	136	A
VOUT_OC_FAULT_LIMIT (Adjustable via PMBus)	All	$I_{O, lim}$	110	-	130	%
Efficiency ($V_{IN} = 54V$, $T_A = 25^{\circ}C$)						
$I_O = 100\% I_{O, max}$, $V_O = V_{O, set}$	All	η	-	97.3	-	%
$I_O = 70\% I_{O, max}$, $V_O = V_{O, set}$	All	η	-	97.4	-	%
Efficiency ($V_{IN} = 51V$, $T_A = 25^{\circ}C$) (typical ORV3)						
$I_O = 100\% I_{O, max}$, $V_O = V_{O, set}$	All	η	-	97.4	-	%
$I_O = 70\% I_{O, max}$, $V_O = V_{O, set}$	All	η	-	97.6	-	%
Switching Frequency (Primary FETs)		fsw		170		kHz
Dynamic Load Response $di_O/dt = 1A/\mu s$; $V_{IN} = V_{IN, nom}$; $T_A = 25^{\circ}C$; (Tested with a 1.0 μF ceramic, and 5200 μF low ESR Polymer capacitor at the load)						
Load Change from $I_O = 50\%$ to 75% of $I_{O, max}$:						
Peak Deviation	All	V_{pk}	-	300	-	mV _{pk}
Settling Time ($V_O < 10\%$ peak deviation) [Delta; Flex is 100]	All	t_s	-	200	-	μs
Load Change from $I_O = 75\%$ to 50% of $I_{O, max}$:						
Peak Deviation	All	V_{pk}	-	300	-	mV _{pk}
Settling Time ($V_O < 10\%$ peak deviation)	All	t_s	-	200	-	μs
Load Change from $I_O = 0\%$ to 50% of $I_{O, max}$		$V_{o, min}$	11.6	-	12.4	V
Load transient, 2 modules parallel condition, 0 to 50% load = 1.6kW		$V_{o, min}$	11.6	-	12.4	V

QODE136A0B Technical Specifications (continued)

General Specifications

Parameter	Device	Symbol	Typ	Unit
Calculated Reliability Based upon Telcordia SR-332 Issue 4: Method I, Case 3, ($I_O = 80\%I_{O,max}$, $T_c = 40^\circ\text{C}$, Airflow = 200 LFM), 90% confidence	All	MTBF	7.22	MHours
	All	FIT	138.4	$10^9/\text{Hours}$
Weight – with Base plate(-H)			95.6	g (oz.)

Feature Specifications

Unless otherwise indicated, specifications apply overall operating input voltage, resistive load, and temperature conditions. See Feature Descriptions for additional information.

Parameter	Device	Symbol	Min	Typ	Max	Unit
Remote On/Off Signal Interface ($V_{IN} = V_{IN,min}$ to $V_{IN,max}$, Signal referenced to V_{IN} -terminal) Negative Logic ("1" device code suffix): Logic Low = module On; Logic High = module Off Positive Logic (no device code suffix): Logic Low = module Off; Logic High = module On Logic Low (pull down to $V_{IN(-)}$ externally) Voltage Sink current Logic High (default; pulled up internally) Internal pull-up voltage Optional external applied voltage Leakage current of external applied device ($V_{on/off} = 2.4\text{V}$)	All	$V_{on/off}$	-	-	0.8	V_{DC}
	All	$I_{on/off}$	-	-	500	μA
	All	$V_{on/off}$	-	3.3	-	V_{DC}
	All	$V_{on/off}$	2.4	-	14.5	V_{DC}
	All	$I_{on/off}$	-	-	130	μA
Turn-On Delay and Rise Times ($I_O = I_{O,max}$, Adjustable) T_{delay} = Time until $V_O = 10\%$ of $V_{O,set}$ from either application of V_{IN} with Remote On/Off set to On (Enable with V_{IN}); or operation of Remote On/Off from Off to On with applied for at least 30 milli-seconds (Enable with on/off).	-P option	T_{delay}	-	-	40	ms
		$T_{delay, Enable}$ with on/off	-	-	10	ms
T_{rise} = Time for V_O to rise from 10% to 90% of $V_{O,set}$. Monotonic [c]	All	T_{rise}	-	15	-	ms
Current Sharing Accuracy (difference from average for all modules with outputs in parallel, no load to full load)	-P option	I_{diff}	-7.5	-	+7.5	% full load
Current Sharing Accuracy with Active Current Share (difference in output current across all modules with outputs in parallel, half load to full load)	-A option	I_{diff}	-5	-	+5	% full load
Remote Sense correction	V_{Sense}				0.5	V_{DC}
$V_{OUT_OV_FAULT_LIMIT}$ (Adjustable via PMBus)	All	$V_{O,limit}$	-	$V_{O,set} + 2\text{V}$	-	V_{DC}
Overtemperature Protection (Adjustable via PMBus)	All	$T_{OTP,set}$	-	110	-	$^\circ\text{C}$
Input Undervoltage Lockout (Adjustable via PMBus) Turn-on Threshold Turn-off Threshold Hysteresis			-	37 35 2	- - -	V_{DC} V_{DC} V_{DC}
Input Overvoltage Lockout (Adjustable via PMBus) Turn-off Threshold ($V_{IN_OV_FAULT_LIMIT}$) Turn-on Threshold			- -	63 61	- -	V_{DC} V_{DC}

QODE136A0B Technical Specifications (continued)

Digital Interface Specifications

Unless otherwise indicated, specifications apply overall operating input voltage, resistive load, and temperature conditions. See Feature Descriptions for additional information.

Parameter	Conditions	Symbol	Min	Typ	Max	Unit
PMBus Signal Interface Characteristics						
Input High Voltage (CLK, DATA)		V_{IH}	2.1		3.6	V
Input Low Voltage (CLK, DATA)		V_{IL}			0.8	V
Input High level current (CLK, DATA)		I_{IH}	-10		10	μA
Input Low level current (CLK, DATA)		I_{IL}	-10		10	μA
Output Low Voltage (CLK, DATA, SMBALERT#)		V_{OL}			0.4	V
Output Low internal sink current (CLK, DATA)	$V_{OL} = 0.4V$	I_{OL}	4			mA
Output Low internal sink current (SMBALERT#)	$V_{OL} = 0.4V$	I_{OL}	2			mA
Output High level internal leakage current (DATA, SMBALERT#)	$V_{OUT} = 3.6V$	I_{OH}	0		10	μA
Pin capacitance		C_O		0.7		pF
PMBus Operating frequency range (*5-10 kHz to accommodate hosts not supporting Clock stretching)	Slave Mode	FPMB	5*		400	KHz
Measurement System Characteristics						
Output current reading range		$I_{OUT(RNG)}$	20		136	A
Output current reading blanking		$I_{OUT(BNK)}$	0		20	A
Output current reading resolution		$I_{OUT(RES)}$		146		mA
Output current reading accuracy (absolute difference between actual and reported values)						
$25^{\circ}C \leq T_A \leq 85^{\circ}C$	$20A < I_{OUT} \leq 68A$	$I_{OUT(ACC)}$	-10		10	A
	$68A < I_{OUT} < 136A$		-5		5	%
$-10^{\circ}C \leq T_A \leq 25^{\circ}C$	$20A < I_{OUT} \leq 68A$		-10		10	A
	$68A < I_{OUT} < 136A$		-10		10	%
$-40^{\circ}C \leq T_A < -10^{\circ}C$	$20A < I_{OUT} \leq 68A$		-15		15	A
	$68A < I_{OUT} < 136A$		-10		10	%
V_{OUT} reading range		$V_{OUT(RNG)}$	0		15.9997	V
V_{OUT} reading resolution		$V_{OUT(RES)}$		0.244		mV
V_{OUT} reading accuracy		$V_{OUT(ACC)}$	-2	0.6	2	%
V_{IN} reading range		$V_{IN(RNG)}$	0		127.875	V
V_{IN} reading resolution		$V_{IN(RES)}$		125		mV
V_{IN} reading accuracy		$V_{IN(ACC)}$	-4	0.8	4	%
Temperature reading resolution		$T_{(RES)}$		0.25		$^{\circ}C$
Temperature reading accuracy		$T_{(ACC)}$	-5		5	$^{\circ}C$

QODE136A0B Technical Specifications (continued)

Characteristic Curves, 12V_{DC} Output

The following figures provide typical characteristics for the QODE136A0B (12V, 136A) at 25°C. The figures are identical for either positive or negative Remote On/Off logic.

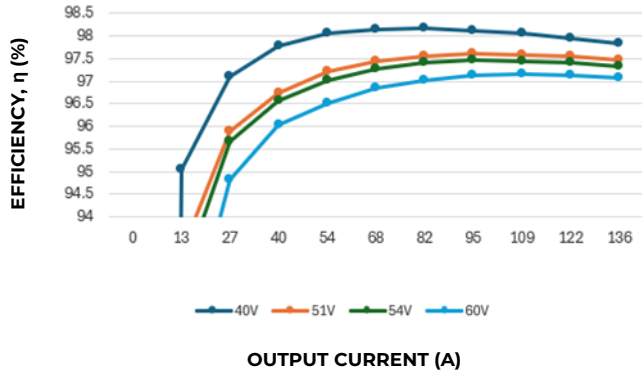

Figure 1. Converter Efficiency versus Output Current.

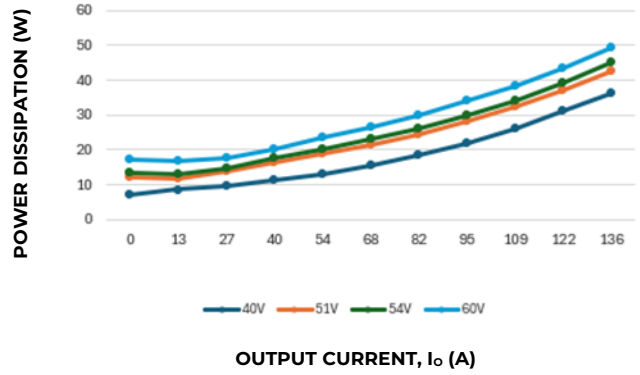

Figure 2. Power Dissipation versus Output Current

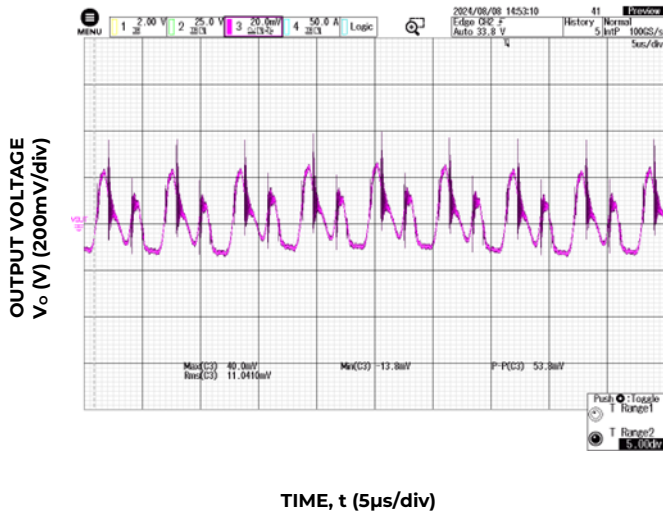

Figure 3. Typical output ripple and noise ($C_o = 250\mu\text{F}$ Ceramic + $3900\mu\text{F}$ PosCap Oscon, $V_{IN} = 54\text{V}$, $I_o = I_{o,max}$)

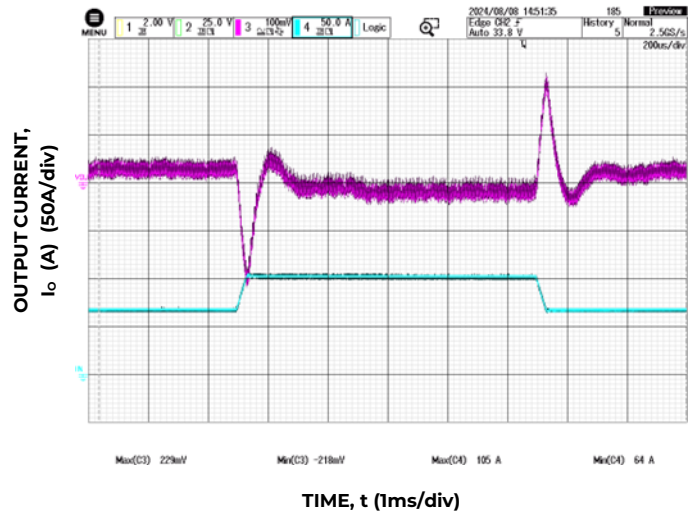

Figure 4. Dynamic Load Response, $di_o/dt=1\text{A}/\mu\text{s}$; $V_{IN}=V_{IN,nom}$; $T_A=25^\circ\text{C}$; Load Change from $I_o = 50\%$ to 75% of $I_{o,max}$; $C_o = 250\mu\text{F}$ Ceramic + $3900\mu\text{F}$ PosCap Oscon

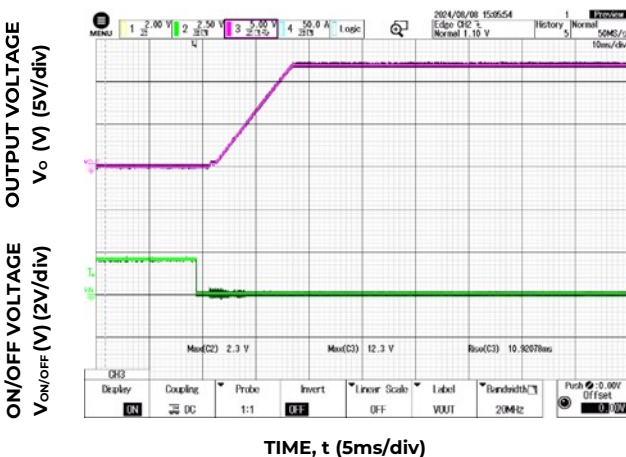

Figure 5. Typical Start-up Using On/Off Voltage $I_o = I_{o,max}$

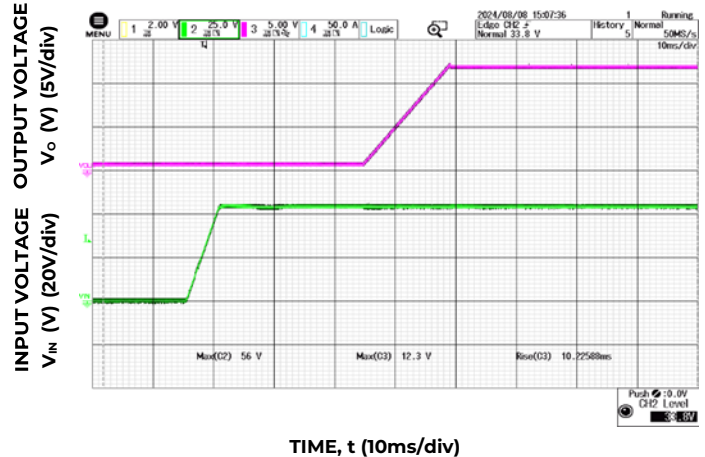

Figure 6. Typical Start-up Using Input Voltage ($V_{IN} = 54\text{V}$, $I_o = I_{o,max}$)

QODE136A0B Technical Specifications (continued)

Characteristic Curves, 12V_{DC} Output (continued)

The following figures provide typical characteristics for the QODE136A0B (12V, 136A) at 25°C. The figures are identical for either positive or negative Remote On/Off logic.

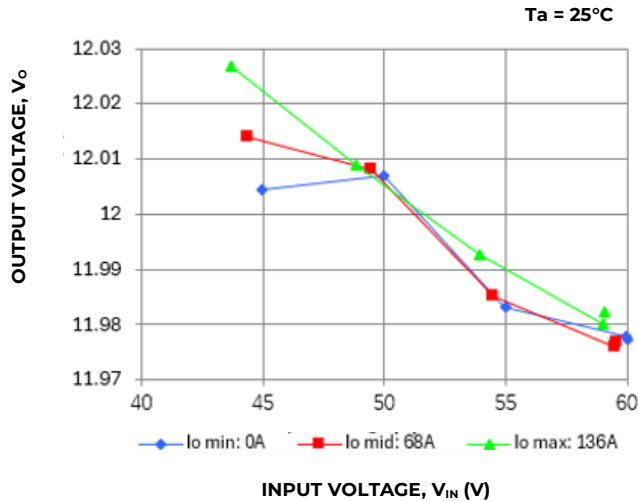

Figure 7. Typical Output Voltage Regulation vs Input Voltage

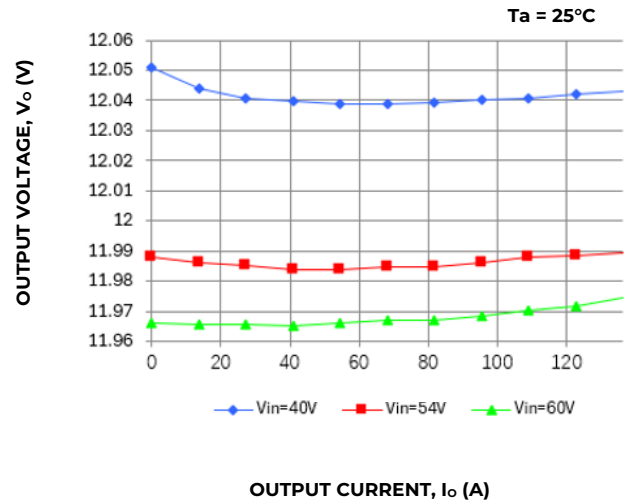

Figure 8. Typical Output Voltage Regulation vs Output Current

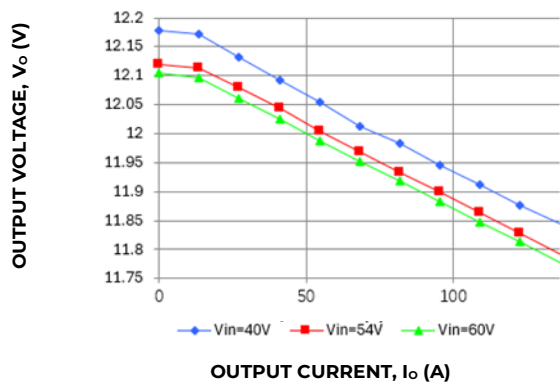

Figure 9. Typical Output Voltage Regulation vs Output Current with droop

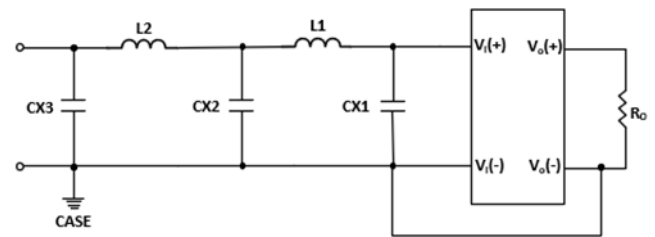

Figure 11. Optional external filter for Class A

Filter components:

$$CX1 = 330\mu\text{F} \times 3 (\text{electrolyte}) + 4.7\mu\text{F} \times 10$$

$$CX2 = 220\mu\text{F} (\text{electrolyte}) + 4.7\mu\text{F} \times 6$$

$$CX3 = 220\mu\text{F} (\text{electrolyte}) + 4.7\mu\text{F} \times 10$$

$$L1 = 1.3\mu\text{H}$$

$$L_{CM1} = L_{CM2} = 10\text{mH}$$

Test Configurations

EMC Specification

Conducted EMI measured according to EN55022 / EN55032. The fundamental switching frequency is 170kHz. The EMI characteristics below is measured at $V_{IN} = 54\text{V}$ and max I_{OUT} .

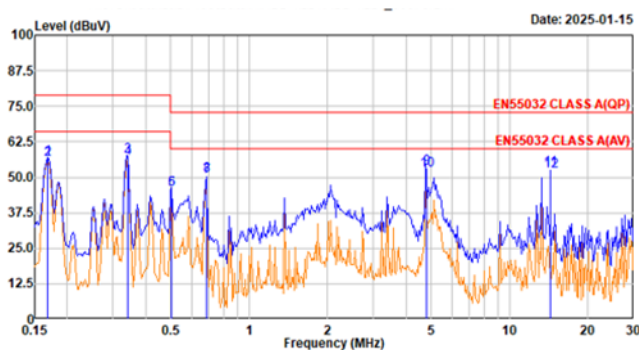
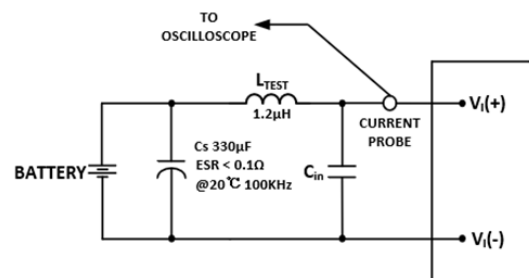

Figure 10. EMI with filter



Note: Measure input ripple current with a simulated source inductance (LTEST) of 1.2 μH . Capacitor C_s offsets possible battery impedance. Measure current as shown above.

Figure 12. Input Ripple Current Test Setup.

QODE136A0B Technical Specifications (continued)

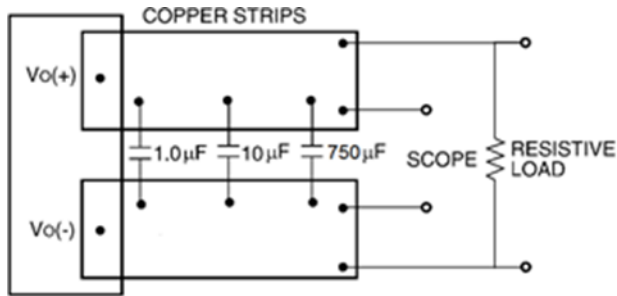

Note: Use a 1.0 µF ceramic capacitor, a 10 µF aluminum or tantalum capacitor and a 750 µF polymer capacitor. Scope measurement should be made using a BNC socket. Position the load between 51 mm and 76 mm (2 in. and 3 in.) from the module.

Figure 13. Output Ripple and Noise Test Setup.

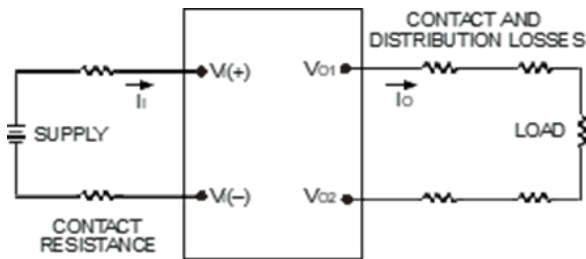

Note: All measurements are taken at the module terminals. When socketing, place Kelvin connections at module terminals to avoid measurement errors due to socket contact resistance.

$$\eta = \left(\frac{[V_{O(+)} - V_{O(-)}]I_{O}}{[V_{I(+)} - V_{I(-)}]I_{I}} \right) \times 100 \%$$

Figure 14. Output Voltage and Efficiency Test Setup.

Design Considerations

Input Source Impedance

The power module should be connected to a low ac-impedance source. Highly inductive source impedance can affect the stability of the power module. For the test configuration in Figure 13, a 660µF electrolytic capacitor, C_{in} , (ESR<0.7W at 100kHz), mounted close to the power module helps ensure the stability of the unit.

Safety Considerations

For safety-agency approval of the system in which the power module is used, the power module must be installed in compliance with the spacing and separation requirements of the end-use safety agency standards listed on the cover page of this datasheet.

If the input source is non-SELV/ES3 (ELV or a hazardous voltage greater than 60 V_{DC} and less than or equal to 75 V_{DC}), for the module's output to be considered as meeting the requirements for safety extra-low voltage (SELV/ES1), all of the following must be true:

The input source is to be provided with reinforced insulation from any other hazardous voltages, including the ac mains.

One V_{IN} pin and one V_{OUT} pin are to be grounded, or both the input and output pins are to be kept floating.

The input pins of the module are not operator accessible.

Another SELV/ES1 reliability test is conducted on the whole system (combination of supply source and subject module), as required by the safety agencies, to verify that under a single fault, hazardous voltages do not appear at the module's output.

Note: Do not ground either of the input pins of the module without grounding one of the output pins. This may allow a non-SELV/ES3 voltage to appear between the output pins and ground.

The power module has safety extra-low voltage (SELV/ES1) outputs when all inputs are SELV/ES1.

The input to these units is to be provided with a maximum 60A fast-acting (or time-delay) fuse in the ungrounded input lead.

Feature Descriptions

Overcurrent Protection

To provide protection in a fault output overload condition, the module is equipped with internal current-limiting circuitry and can endure current limiting continuously. If the overcurrent condition causes the output voltage to fall greater than 0.8V from $V_{O,SET}$, the module will shut down and remain latched off. The overcurrent latch is reset by either cycling the input power or by toggling the on/off pin for one second. If the output overload condition still exists when the module restarts, it will shut down again. This operation will continue indefinitely until the overcurrent condition is corrected.

A factory configured auto-restart option (with overcurrent and overvoltage auto-restart managed as a group, module code: 4) is also available. An auto-restart feature continually attempts to restore the operation until fault condition is cleared.

Remote ON/OFF

The module contains a standard on/off control circuit referenced to the $V_{IN}(-)$ terminal, where the ON/OFF input is pulled up internally to 3.3V, a logic high, with no external connection.

Two factory configured remote on/off logic options are available: The factory-preferred configuration is negative logic (indicated by device code suffix "1"), where the module is Off during a logic high (default) and On during a logic low.

QODE136A0B Technical Specifications (continued)

The other option (no suffix “1”) is positive logic where the module is On during a logic high (default) and Off during a logic low.

The On/Off circuit is powered from an internal bias supply, derived from the 3.3V. To turn the power module on and off, the user must supply a switch to control the voltage between the On/Off terminal and the $V_{IN(-)}$ terminal ($V_{on/off}$). The switch can be an open collector or equivalent (see Figure 15). The switch should maintain $<0.8V$ while sinking up to $200\mu A$. During a logic high when the switch is off, the maximum allowable leakage current at $V_{on/off} = 2.4V$ is $130\mu A$. If using an external voltage source, the maximum voltage $V_{on/off}$ on the pin is $14.5V$ with respect to the $V_{IN(-)}$ terminal.

If not using the remote on/off feature, perform one of the following to turn the unit on:

For negative logic, short ON/OFF pin to $V_{IN(-)}$.

For positive logic: leave ON/OFF pin open.

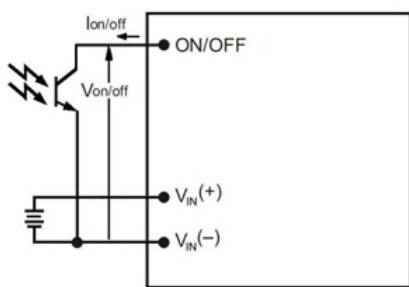

Figure 15. Remote On/Off Implementation.

Output Overvoltage Protection

The module contains circuitry to detect and respond to output overvoltage conditions. If the overvoltage condition causes the output voltage to rise above the limit in the Specifications Table, the module will shut down and remain latched off. The overvoltage latch is reset by either cycling the input power, or by toggling the on/off pin for one second. If the output overvoltage condition still exists when the module restarts, it will shut down again. This operation will continue indefinitely until the overvoltage condition is corrected.

A factory configured auto-restart option (with overcurrent and overvoltage auto-restart managed as a group, module code: 4) is also available. An auto-restart feature continually attempts to restore the operation until fault condition is cleared.

Overtemperature Protection

These modules feature an overtemperature protection circuit to safeguard against thermal damage. The circuit shuts down the module when the maximum device reference temperature is exceeded. The module will automatically restart once the reference temperature cools by $\sim 18^{\circ}C$.

Input Under/Over voltage Lockout

At input voltages above or below the input Over/under voltage lockout limits, module operation is disabled.

The module will begin to operate when the input voltage level changes to within the under and overvoltage lockout limits. However recovery from input undervoltage may be delayed by 7 microseconds, or 8 seconds if the module is hot.

Load Sharing

For higher power requirements, the QODE136A0B module offers an optional feature for parallel operation (-P Option code). This feature provides a precise forced output voltage load regulation droop characteristic. The output set point and droop slope are factory calibrated to ensure optimum matching of multiple modules' load regulation characteristics. To implement load sharing, the following requirements should be followed:

The $V_{OUT(+)}$ and $V_{OUT(-)}$ pins of all parallel modules must be connected together. Balance the trace resistance for each module's path to the output power planes, to ensure best load sharing and operating temperature balance.

V_{IN} must remain between $40V_{DC}$ and $60V_{DC}$ for droop sharing to be functional.

It is permissible to use a common Remote On/Off signal to start all modules in parallel. However if spurious shutdowns occur at startup due to very low impedance between module outputs, the modules should be started sequentially instead, waiting at least the Turn-On Delay Time + Rise Time before starting the next module.

These modules contain means to block reverse current flow upon start-up, when output voltage is present from other parallel modules, thus eliminating the requirement for external output ORing devices. Modules with the -P option may automatically increase the Turn On delay, T_{delay} , as specified in the Feature Specifications Table, if output voltage is present on the output bus at startup.

When parallel modules startup into a pre-biased output, e.g. partially discharged output capacitance, the T_{rise} is automatically increased, as specified in the Feature Specifications Table, to ensure graceful startup.

Ensure that the total load is $I_{O,MAX}$ (for a single module) until all parallel modules have started. Full load may be applied after $Max T_{delay} + T_{rise}$.

If fault tolerance is desired in parallel applications, output ORing devices should be used to prevent a single module failure from collapsing the load bus.

QODE136A0B Technical Specifications (continued)

Feature Descriptions (continued)

The current sharing accuracy equation is:

$$X\% = |I_{o,n} - I_{o_total} / n| / I_{O_MAX}$$

$I_{o,n}$ is the output current of module n

I_{o_total} is the output current of total

I_{O_MAX} is the rated full load current of per module

n is the module parallel number.

Active current sharing

The modules can provide active current sharing to improve the load-current matching among modules connected in parallel, while output-voltage droop with load remains active.

To enable active current sharing, simply connect the Ishare pins of all modules with outputs connected in parallel, and follow the guidelines described in the Load Sharing section. The voltage on the Ishare pins will be $I_o * 3.3 / (136 * 1.1)$

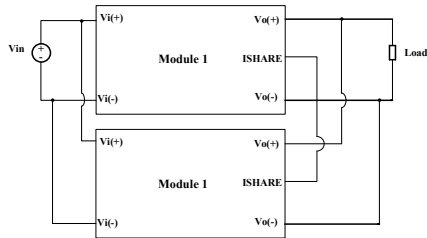

Figure 16. Parallel and active current sharing configuration.

Power Good, PG (option)

The QODE136A0B- module provides a Power Good (PG) option, which compares the module's output voltage to the module's POWER_GOOD_ON and POWER_GOOD_OFF values. These values are adjustable via PMBus. PG is asserted when the module's output voltage is above the POWER_GOOD_ON value, and PG is de-asserted if any condition such as overtemperature, overcurrent or loss of regulation occurs that would result in the output voltage going below the POWER_GOOD_OFF value.

The PG signal, provided on pin 8, is implemented with an open-drain node, it should be pulled up via a 10kΩ resistor to 3.3V externally. For Positive Logic PG (default), the PG signal is HI, when PG is asserted, and LO, when the PG is de-asserted. For Negative Logic PG, the PG signal is LO, when PG is asserted, and HI, when the PG is de-asserted.

The PMBus command MFR_PGOOD_POLARITY is used to set the logic polarity of the signal.

If not using the Power Good feature, the pin may be left N/C.

Default code is w/o PG pin.

Please contact OmniOn Power™ representative for this option.

Thermal Considerations

The power modules operate in a variety of thermal environments and sufficient cooling should be provided to help ensure reliable operation. Thermal considerations include ambient temperature, airflow, module power dissipation, and the need for increased reliability. A reduction in the operating temperature of the module will result in an increase in reliability. Heat-dissipating components are mounted on the top side of the module. Heat is removed by conduction, convection and radiation to the surrounding environment. Proper cooling can be verified by measuring the thermal reference temperature.

Peak temperature occurs at the position indicated in Figure 16. For reliable operation, this temperature should not exceed $TH1=95^{\circ}C$ any airflow condition. For extremely high reliability you can limit this temperature to a lower value.

The output power of the module should not exceed the rated power for the module as listed in the Ordering Information table, or the derated power for the actual operating conditions as indicated in Figs. 17 -22.

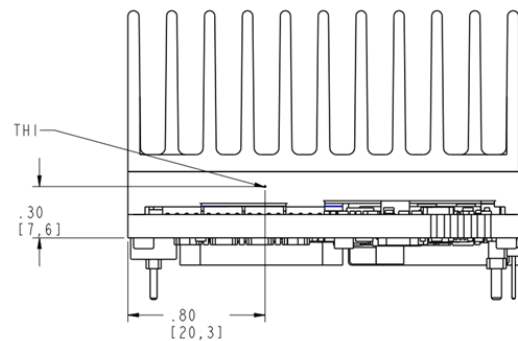

Figure 17. Location of the thermal reference temperature TH1 for base plate module with 1 inch height heatsink.

Heat Transfer via Convection

The thermal data presented here is based on physical measurements taken in a wind tunnel, using automated thermo-couple instrumentation to monitor key component temperatures: FETs, diodes, control ICs, magnetic cores, ceramic capacitors, opto-isolators, and module PWB conductors, while controlling the ambient airflow rate and temperature. For a given airflow and ambient temperature, the module output power is increased, until one (or more) of the components reaches its maximum derated operating temperature, as defined in IPC-9592B. This procedure is then repeated for a different airflow or ambient temperature until a family of module output derating curves is obtained. Please refer to the Application Note "Thermal Characterization Process For Open-Frame Board-Mounted Power Modules" for a detailed discussion of thermal aspects including maximum device temperatures.

QODE136A0B Technical Specifications (continued)

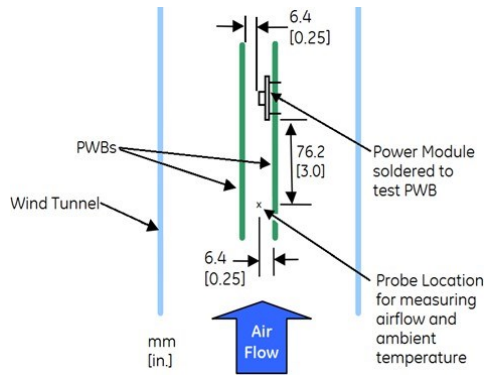

Figure 18. Thermal Test Setup

Increased airflow over the module enhances the heat transfer via convection. The thermal derating of figure 18–19 shows the maximum output current that can be delivered by each module in the indicated orientation without exceeding the maximum TH1 temperature versus local ambient temperature (TA) for several air flow conditions.

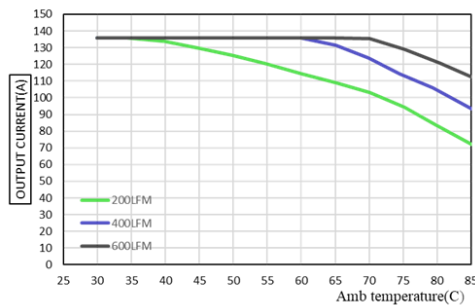

Figure 19. Maximum Output Current Derating for the QODE136A0B base plate module with 1 inch height heatsink; Airflow Direction for Vin- to Vin+ orientation; Vin = 51V.

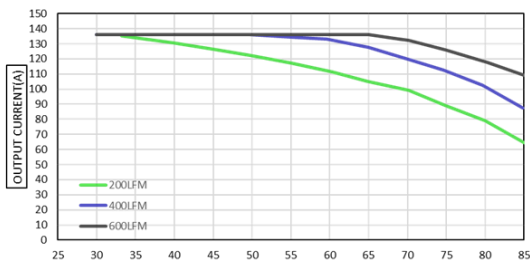

Figure 20. Maximum Output Current Derating for the QODE136A0B base plate module with 1 inch height heatsink; Airflow Direction for Vin- to Vin+ orientation; Vin = 54V

Layout Considerations

The QODE136A0B power module series are low profile in order to be used in fine pitch system card architectures. As such, component clearance between the bottom of the power module and the mounting board is limited. Avoid placing copper areas on the outer layer directly underneath the power module. Also avoid placing via interconnects underneath the power module.

For additional layout guide-lines, refer to FLT012A0Z Preliminary Data Sheet.

Through-Hole Lead-Free Soldering Information

The RoHS-compliant, Z version, through-hole products use the SAC (Sn/Ag/Cu) Pb-free solder and RoHS-compliant components. The module is designed to be processed through single or dual wave soldering machines. The pins have a RoHS-compliant, pure tin finish that is compatible with both Pb and Pb-free wave soldering processes. A maximum preheat rate of 3°C/s is suggested. The wave preheat process should be such that the temperature of the power module board is kept below 210°C. For Pb solder, the recommended pot temperature is 260°C, while the Pb-free solder pot is 270°C max.

Reflow Soldering

The base plate version(-H) RoHS-compliant through-hole products can be processed with the following pin-in-paste (paste-in-hole) Pb or Pb-free reflow process.

Max. sustain temperature:

245°C (J-STD-020C Table 4-2: Packaging Thickness >= 2.5mm / Volume > 2000mm³),

Peak temperature over 245°C is not suggested due to the potential reliability risk of components under continuous high-temperature.

Min. sustain duration above 217°C : 90 seconds
Min. sustain duration above 180°C : 150 seconds
Max. heat up rate: 3°C /sec

Max. cool down rate: 4°C C/sec

In compliance with JEDEC J-STD-020C spec for 2 times reflow requirement.

Pb-free Reflow Profile

BMP module will comply with JEDEC J-STD-020 Rev. D (Moisture/Reflow Sensitivity Classification for Non-hermetic Solid-State Surface Mount Devices) for both Pb-free solder profiles and MSL classification procedures.

BMP will comply with J-STD-020C specification for reflow up to 3 times. When removing a module, using localized hot air counts as one reflow, but using a solder pot instead to heat the pins does not count as a reflow.

The suggested Pb-free solder paste is Sn/Ag/Cu (SAC). The recommended linear reflow profile using Sn/Ag/Cu solder is shown in Figure 24.

MSL Rating

The QODE136A0B base plate modules have a MSL rating as indicated in the Device Codes table, last page of this document. The -F option with integrated heatsink is not qualified for pin-in-paste reflow.

QODE136A0B Technical Specifications (continued)

Storage and Handling

The recommended storage environment and handling procedures for moisture-sensitive surface mount packages is detailed in J-STD-033 Rev. A (Handling, Packing, Shipping and Use of Moisture/Reflow Sensitive Surface Mount Devices). Moisture barrier bags (MBB) with desiccant are required for MSL ratings of 2 or greater. These sealed packages should not be broken until time of use. Once the original package is broken, the floor life of the product at conditions of $\leq 30^{\circ}\text{C}$ and 60% relative humidity varies according to the MSL rating (see J-STD-060A). The shelf life for dry packed SMT packages will be a minimum of 12 months from the bag seal date, when stored at the following conditions: $< 40^{\circ}\text{C}$, $< 90\%$ relative humidity.

Post Solder Cleaning and Drying

Post solder cleaning is usually the final circuit board assembly process prior to electrical board testing. The result of inadequate cleaning and drying can affect both the reliability of a power module and the testability of the finished circuit board assembly. For guidance on appropriate soldering, cleaning and drying procedures, refer to OmniOn Power™ Board Mounted Power Modules: Soldering and Cleaning Application Note (AN04-001).

If additional information is needed, please consult with your OmniOn Power™ Sales representative for more details.

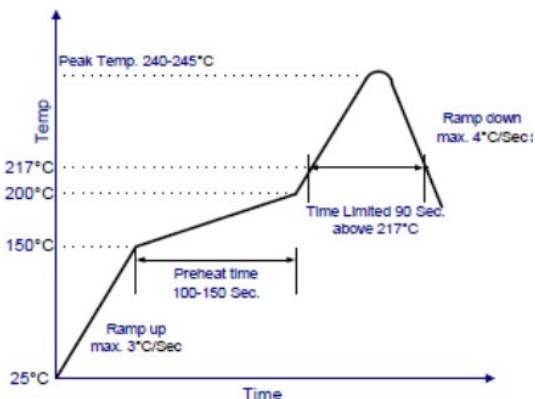

Figure 21. Recommended linear reflow profile using Sn/Ag/Cu solder.

Digital Feature Descriptions

PMBus Interface Capability

The QODE136A0B series is equipped with a digital PMBus interface to allow the module to be configured, and communicate with system controllers. Detailed timing and electrical characteristics of the PMBus can be found in the PMBus Power Management Protocol Specification, Part 1, revision 1.2, available at <http://pmbus.org>. The QODE136A0B supports both the 100kHz and 400kHz bus timing requirements.

The QODE136A0B shall stretch the clock, as long as it does not exceed the maximum clock LO period of 35ms. The power module will check the Packet Error Checking scheme (PEC) byte, if provided by the PMBus master, and include a PEC byte in all responses to the master.

The power module supports a subset of the commands in the PMBus 1.2 specification. Most all of the controller parameters can be programmed using the PMBus and stored as defaults for later use.

All commands that require data input or output use the linear format. The exponent of the data words is fixed at a reasonable value for the command and altering the exponent is not supported. Direct format data input or output is not supported by the power module. The supported commands are described in greater detail below.

The power module contains non-volatile memory that is used to store configuration settings and scale factors. The settings programmed into the device are not automatically saved into this non-volatile memory though. The STORE_DEFAULT_ALL command must be used to commit the current settings to non-volatile memory as device defaults. The settings that are capable of being stored in non-volatile memory are noted in their detailed descriptions.

SMBALERT Interface Capability

The power module also supports the SMBALERT response protocol. The SMBALERT response protocol is a mechanism through which the power module can alert the PMBus master that it has an active status or alarm condition via pulling the SMBALERT pin to an active low. The master processes this condition, and simultaneously addresses all slaves on the PMBus through the Alert Response Address. Only the slave(s) that caused the alert (and that support the protocol) acknowledges this request. The master performs a modified receive byte operation to get the slave's address. At this point, the master can use the PMBus status commands to query the slave that caused the alert. Note: The power module can only respond to a single address at any given time. Therefore, the factory default state for the power module is to retain its resistor programmed address, when it is in an ALERT active condition, and not respond to the ARA. This allows master systems, which do not support ARA, to continue to communicate with the slave power module using the programmed address, and using the various READ_STATUS commands to determine the cause for the SMBALERT. The CLEAR_FAULTS command will retire the active SMBALERT. However, when the power module is used in systems that do support ARA, Bit 4 of the MFR_CPIN_ARA_CONFIG command can be used to reconfigure the module to utilize ARA. In this case, the power module will no longer respond to its programmed address, when in an ALERT active state. The master is expected to perform the modified received byte operation, and retire the ALERT active signal.

QODE136A0B Technical Specifications (continued)

At this time, the power module will return to its resistor programmed address, allowing normal master-slave communications to proceed. The power module does not contain capability to arbitrate data bus contention caused by multiple modules responding to the modified received byte operation. Therefore, when the ARA is used in a multiple module PMBus application, it is necessary to have the power module at the lowest programmed address in order for the host to properly determine all modules' address that are associated with an active SMBAlert.

Please contact your OmniOn Power™ sales representative for further assistance, and for more information on the SMBus alert response protocol, see the System Management Bus (SMBus) specification.

PMBus Addressing

The power module has flexible PMBUS addressing capability. By connecting different resistors from Addr1 pin to VOUT(-) pin, 14 possible addresses can be acquired. The 7bit PMBUS address is defined by the value of the resistor as shown in the table below, and +/-1% resistor accuracy is acceptable. If there is any resistance exceeding the requested range, address 127 will be returned. The address in table below is in decimal.

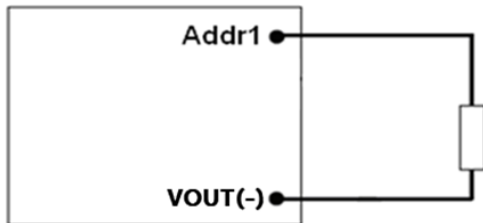

PMBUS address	Resistor (Kohm)
96	10
97	15
98	21
99	28
100	35.7
101	45.3
102	56.2
103	69.8
104	88.7
105	107
106	130
107	158
108	191
109	232

Figure 22. Circuit showing connection of resistors used to set the PMBus address of the module. (required [c])

The user must know which I²C addresses are reserved in a system for special functions and set the address of the module to avoid interfering with other system operations. Both 100kHz and 400kHz bus speeds are supported by the module. Connection for the PMBus interface should follow the High Power DC specifications given in section 3.1.3 in the SMBus specification V2.0 for the 400kHz bus speed or the Low Power DC specifications in section 3.1.2. The complete SMBus specification is available from the SMBus web site, smbus.org.

PMBus Data Formats

For commands that set or report any voltage thresholds related to output voltage (including VOUT_COMMAND, VOUT_MARGIN), the module supports the “VOUT linear” data format consisting of a two byte value with a 16-bit, unsigned mantissa, and a fixed exponent of -12. The format of the two data bytes is shown below:

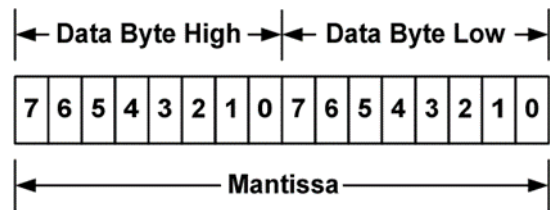

The value of the number is then given by

$$\text{Value} = \text{Mantissa} \times 2^{-12}$$

For commands that set all other thresholds, voltages or report such quantities, the module supports the “linear” data format consisting of a two byte value with an 11-bit, two’s complement mantissa and a 5-bit, two’s complement exponent. The format of the two data bytes is shown below:

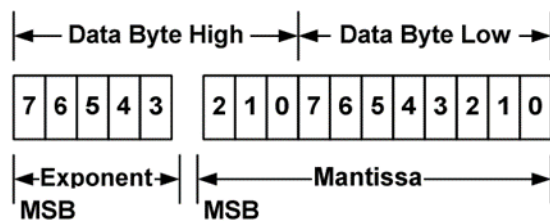

The value of the number is then given by $\text{Value} = \text{Mantissa} \times 2^{\text{Exponent}}$

For both formats, the “low” byte is transmitted first according to the PMBus and SMBus specifications.

Write Protection

Write protection is enabled by default, to prevent accidentally changing settings. The MFR_DEVICE_TYPE (0xD0) command is used to disable or enable write protection as described below. To keep changes beyond the next removal of input voltage, the STORE_DEFAULT_ALL (0x11) command is used to save all settings to non-volatile memory.

QODE136A0B Technical Specifications (continued)

PMBus Enabled On/Off

The module can also be turned On and Off via the PMBus interface using the OPERATION command, while an ON_OFF_CONFIG setting determines whether the module responds to this command.

The “ON” bit [7] in the OPERATION command data byte enables the module as follows:

0	:	Output is disabled
1	:	Output is enabled (default)

The “CMD” bit [3] in the ON_OFF_CONFIG data byte controls how the device responds to the ON bit:

Bit Value	Action
0	Module ignores the ON bit in the OPERATION command; control is by the On/Off pin only.
1	Module responds to the ON bit in the OPERATION command (default)

All other bits in the ON_OFF_CONFIG data byte are fixed at 1.

In summary, to turn On the module output, the ON/Off pin must be set to On according to the On/Off logic indicated in the product code, e.g., connected to the VIN(-) rail for module option 1 (=Negative logic). Then if CMD=1, the ON bit of the OPERATION command may be used to turn the module off & on as long as the ON/OFF pin is set to On.

PMBus Adjustable Input Undervoltage Lockout

The module allows adjustment of the input under voltage lockout and hysteresis. The command VIN_ON allows setting the input voltage turn on threshold, while the VIN_OFF command sets the input voltage turn off threshold. For both the VIN_ON and VIN_OFF commands, possible values in 0.125V steps are specified below. VIN_ON must be 2.000V greater than VIN_OFF.

Both the VIN_ON and VIN_OFF commands use the “Linear” format with two data bytes. The upper five bits [7:3] of the high data byte form the two’s complement representation of the exponent, which is fixed at -3 (decimal). The remaining 11 bits are used for two’s complement representation of the mantissa, with the 11th bit fixed at zero since only positive numbers are valid. The data associated with VIN_ON and VIN_OFF can be stored to non-volatile memory using the STORE_DEFAULT_ALL command.

PMBus Adjustable Soft Start Delay and Rise Time

The soft start delay and rise time can be adjusted in the module via PMBus. The TON_DELAY command sets the delay time in ms, and allows choosing delay times between 10ms and 500ms, with resolution of 0.5ms. The TON_RISE command sets the rise time in ms, and allows choosing soft start times between 15ms and 500ms, with resolution of 0.5ms.

When setting TON_RISE, make sure that the charging current for output capacitors can be delivered by the module in addition to any load current to avoid nuisance tripping of the overcurrent protection circuitry during startup. Both the TON_RISE and TON_DELAY commands use the “Linear” format with two data bytes. The upper five bits [7:3] of the high data byte form the two’s complement representation of the exponent, which is fixed at -1 (decimal). The remaining 11 bits are used for two’s complement representation of the mantissa, with the 11th bit fixed at zero since only positive numbers are valid. The data associated with TON_RISE and TON_DELAY can be stored to non-volatile memory using the STORE_DEFAULT_ALL command.

Output Voltage Adjustment Using the PMBus

The power module output voltage set point is adjusted using the VOUT_COMMAND. The output voltage setting uses the Linear data format, with the 16 bits of the VOUT_COMMAND formatted as an unsigned mantissa, and a fixed exponent of -12 (decimal) (read from VOUT_MODE).

$$VOUT = \text{Mantissa} \times 2^{-12}$$

The range limits for VOUT_COMMAND are 9.5V to 12.5V, and the resolution is 0.244mV.

The data associated with VOUT_COMMAND can be stored to non-volatile memory using the STORE_DEFAULT_ALL command.

Output Voltage Margining Using the PMBus

The power module can also have its output voltage margined via PMBus commands. The command VOUT_MARGIN_HIGH sets the margin high voltage, while the command VOUT_MARGIN_LOW sets the margin low voltage. Both the VOUT_MARGIN_HIGH and VOUT_MARGIN_LOW commands use the “Linear” mode with the exponent fixed at -12 (decimal). The data associated with VOUT_MARGIN_HIGH and VOUT_MARGIN_LOW can be stored to non-volatile memory using the STORE_DEFAULT_ALL command.

The module is commanded to go to the margined high or low voltages using the OPERATION command. Bits [5:2] are used to enable margining as follows:

00XX	:	Margin Off
0110	:	Margin Low (Act on Fault)
1010	:	Margin High (Act on Fault)

Measuring Output Voltage Using the PMBus

The module can provide output voltage information using the READ_VOUT command. The command returns two bytes of data in the linear format, with the 16 bits of the READ_VOUT formatted as an unsigned mantissa, and a fixed exponent of -12 (decimal).

QODE136A0B Technical Specifications (continued)

During module manufacture, an offset correction value is written into the non-volatile memory of the module to null errors in the tolerance and A/D conversion of V_{OUT}. The command MFR_VOUT_READ_CAL_OFFSET can be used to read the offset - two bytes consisting of a signed 16-bit mantissa in two's complement format, using a fixed exponent of -12 (decimal). The resolution is 0.244mV. The corrected Output voltage reading is then given by:

$$V_{OUT}(\text{Read}) = [V_{OUT}(\text{A/D}) + \text{MFR_VOU T_READ_CAL_OFFSET}]$$

Measuring Input Voltage Using the PMBus

The module can provide input voltage information using the READ_VIN command. The command returns two bytes of data in the linear format. The upper five bits [7:3] of the high data byte form the two's complement representation of the exponent, which is fixed at -3 (decimal). The remaining 11 bits are used for two's complement representation of the mantissa, with the 11th bit fixed at zero since only positive numbers are valid.

During module manufacture, offset and gain correction values are written into the non-volatile memory of the module to null errors in the tolerance and A/D conversion of V_{in}. The command MFR_VIN_READ_CAL_OFFSET can be used to read the offset - two bytes consisting of a five-bit exponent (fixed at -3) and a 11-bit mantissa in two's complement format. The resolution is 125mV. The command MFR_VIN_READ_CAL_GAIN can be used to read the gain correction - two bytes consisting of an unsigned 16 bit number. The resolution of this correction factor 0.000122. The corrected input voltage reading is then given by:

$$V_{IN}(\text{Read}) = [V_{IN}(\text{A/D}) \times (\text{MFR_VIN_READ_CAL_GAIN}/8192)] + \text{MFR_VIN_READ_CAL_OFFSET}$$

Measuring Output Current Using the PMBus

The module measures output current by using the output filter inductor winding resistance as a current sense element. The module can provide output current information using the READ_IOUT command. The command returns two bytes of data in the linear format. The upper five bits [7:3] of the high data byte form the two's complement representation of the exponent, which is fixed at -3 (decimal). The remaining 11 bits are used for two's complement representation of the mantissa, with the 11th bit fixed at zero since only positive numbers are valid. Output current readings are blanked below 20A.

During module manufacture, offset and gain correction values are written into the non-volatile memory of the module to null errors in the tolerance and A/D conversion of I_{OUT}. The command MFR_IOUT_CAL_OFFSET can be used to read the offset - two bytes consisting of a five-bit exponent (fixed at -3) and a 11-bit mantissa in two's complement format. The resolution is 125mA. The command MFR_IOUT_CAL_GAIN can be used to read the gain correction - two bytes consisting of an unsigned 16 bit number. The resolution of this correction factor 0.000122. The READ_IOUT command provides module average output current information. This command only supports positive current sourced from the module. If the converter is sinking current a reading of 0 is provided.

$$I_{OUT}(\text{Read}) = [I_{OUT}(\text{A/D}) \times (\text{MFR_IOUT_CAL_GAIN}/8192)] + \text{MFR_IOUT_CAL_OFFSET}$$

Note that the current reading provided by the module is corrected for temperature.

Measuring the Temperature using the PMBus

The module can provide temperature information using the READ_TEMPERATURE_1 command. The command returns two bytes of data in the linear format. The upper five bits [7:3] of the high data byte form the two's complement representation of the exponent, which is fixed at -2 (decimal). The remaining 11 bits are used for two's complement representation of the mantissa.

Note that the module's temperature sensor is located close to the module hot spot TH1 (see Thermal Considerations) and is subjected to temperatures higher than the ambient air temperature near the module. The temperature reading will be highly influenced by module load and airflow conditions.

Reading the Status of the Module using the PMBus

The module supports a number of status information commands implemented in PMBus. However, not all features are supported in these commands. A X in the FLAG cell indicates the bit is not supported.

QODE136A0B Technical Specifications (continued)

STATUS_WORD : Returns two bytes of information with a summary of the module's fault/warning conditions.

High Byte

Bit Position	Flag	Default Value
15	VOUT fault	0
14	IOUT fault or warning	0
13	Input Voltage fault	0
12	X	0
11	POWER_GOOD# (is negated)	0
10	X	0
9	X	0
8	X	0

Low Byte

Bit Position	Flag	Default Value
7	X	0
6	OFF	0
5	VOUT Overvoltage	0
4	IOUT Overcurrent	0
3	VIN Undervoltage	0
2	Temperature	0
1	CML (Comm. Memory Fault)	0
0	X	0

STATUS_VOUT : Returns one byte of information relating to the status of the module's output voltage related faults.

Bit Position	Flag	Default Value
7	VOUT OV Fault	0
6	X	0
5	X	0
4	X	0
Bit Position	Flag	Default Value
3	X	0
2	X	0
1	X	0
0	X	0

STATUS_IOUT : Returns one byte of information relating to the status of the module's output current related faults.

Bit Position	Flag	Default Value
7	IOUT OC Fault	0
6	X	0
5	IOUT OC Warning	0
4	X	0
3	X	0
2	X	0
1	X	0
0	X	0

STATUS_INPUT : Returns one byte of information relating to the status of the module's input voltage related faults.

Bit Position	Flag	Default Value
7	VIN OV Fault	0
6	X	0
5	X	0
4	VIN UV Fault	0
3	Module Off (Low VIN)	0
2	X	0
1	X	0
0	X	0

STATUS_TEMPERATURE : Returns one byte of information relating to the status of the module's temperature related faults.

Bit Position	Flag	Default Value
7	OT Fault	0
6	OT Warning	0
5	X	0
4	X	0
3	X	0
2	X	0
1	X	0
0	X	0

STATUS_CML : Returns one byte of information relating to the status of the module's communication related faults.

Bit Position	Flag	Default Value
7	Invalid/Unsupported Command	0
6	Invalid/Unsupported Data	0
5	Packet Error Check Failed	0
4	X	0
3	X	0
2	X	0
1	X	0
0	X	0

Black box

There is a black box function realized by D-flash in power module, can record the latest 20 events including status registers, fault time, etc.

Requires 20K erase cycles up to 120°C hotspot temp; Vin UVLO event is not record in black box. Fault time means the time elapse from Vo turn on, unit is second. Each event has the same record content, which is shown [c]

Please contact OmniOn Power™ representative for details.

Q0DE136A0B Technical Specifications (continued)

Summary of Supported PMBus Commands

(comply with [c])

This section outlines the PMBus command support for the Q0DE136A0B bus converters. Each supported command is outlined in order of increasing command codes with a quick reference table of all supported commands included at the end of the section.

Each command will have the following basic information.

Command Name [Code]

Definition

Data format

Factory default

Additional information may be provided if necessary.

OPERATION (0x01)

Command support: On/Off Immediate and Margins (Act on Fault). Soft off with sequencing not supported and Margins (Ignore Fault) not supported. Therefore bits 6, 3, 2, 1 and 0 set as read only at factory defaults.

Format	8 bit unsigned (bit field)							
Bit Position	7	6	5	4	3	2	1	0
Access	r/w	r	r/w	r/w	r	r	r	r
Function	ON/OFF		Bits[5:4]		Bits[3:2]		N/A	
Default Value	1	0	0	0	1	0	0	0

ON_OFF_CONFIG (0x02)

Command support: Bit 1 polarity will be set based upon module code [0=Negative on/off logic, 1=positive on/off logic to allow customer system to know hardware on/off logic.

Format	8 bit unsigned (bit field)							
Bit Position	7	6	5	4	3	2	1	0
Access	r	r	r	r	r	r/w	r/w	r
Function	(reserved)			Bit 4 pu	Bit 3 cmd	Bit 2 cpr	Bit 1 pol	Bit 0 cpa
Default Value	0	0	0	1	1	1	module code	1

CLEAR_FAULTS (0x03)

Command support: All functionality

WRITE_PROTECT (0x10)

STATUS_VOUT: All functionality

STORE_DEFAULT_ALL (0x11)

Command support: All functionality – Stores operating parameters to EEPROM memory.

Command requires ≤ 500ms to execute. Delay any additional commands to module for sufficient time to complete execution.

VOUT_MODE[0x20]

Command support: Supported. Factory default: 0x14 – indicates linear mode with exp = -12.

Format	8 bit unsigned (bit field)							
Bit Position	7	6	5	4	3	2	1	0
Access	r	r	r	r	r	r	r	r
Function	Mode (linear)				2's complement exponent			
Default Value	0	0	0	1	0	1	0	0

QODE136A0B Technical Specifications (continued)

Summary of Supported PMBus Commands (continued)

VOUT_COMMAND [0x21]

Data format: 16 bit unsigned mantissa (implied exponent per VOUT_MODE)

Factory default: 12.000V ($12.00/2^{-12} \rightarrow 49,152 = 0xC000$) [standard code]

Range limits (max/min): 12.500/9.500V

Units: volt

Command support: Supported

VOUT_CAL_OFFSET [0x23]

Range limits (max/min): +0.25/-0.25

Units: volt

Command support: read/write support, lockout per MFR_DEVICE_TYPE, functionality implemented

VOUT_MARGIN_HIGH [0x25]

Range limits (max/min): 13.200/8.100V

Units: volt

Command support: read/write support, full functionality except "Ignore faults".

Note: Range cross-check - value must be greater than VOUT_MARGIN_LOW value.

VOUT_MARGIN_LOW [0x26]

Range limits (max/min): 13.200/8.100V

Units: volt

Command support: read/write support, full functionality except "Ignore faults".

Note: Range cross-check - value must be less than VOUT_MARGIN_HIGH value.

VOUT_DROOP [0x28]

Range limits (max/min): 5.0/0

Units: mv/A

Command support: All functionality

VIN_ON [0x35]

Range limits (max/min): 49/35

Units: volt

Command support: All functionality

Note: Special interlock checks between VIN_ON and VIN_OFF maintain a hysteresis gap of 2V minimum and do not allow the OFF level to be higher than and ON level.

VIN_OFF [0x36]

Range limits (max/min): 46/32

Units: volt

Command support: All functionality

Note: Special interlock checks between VIN_ON and VIN_OFF maintain a hysteresis gap of 2V minimum and do not allow the OFF level to be higher than and ON level.

QODE136A0B Technical Specifications (continued)

Summary of Supported PMBus Commands (continued)

VOUT_OV_FAULT_LIMIT [0x40]

Range limits (max/min): 15.99/10.9 (See note 2)

Units: volt

Command support: All functionality

Note:

1. Range cross-check – value must be greater than VOUT_COMMAND value.
2. The maximum OV Fault Limit equals the output set point plus 2V, up to 15.99V. This is an automatic module protection feature that will override a user-set fault limit if the user limit is set too high.

VOUT_OV_FAULT_RESPONSE [0x41]

Command support:

- Response settings (bits RSP0:1) – only a setting of 10, unit shuts down and responds according to the retry settings below, is supported.
- Retry settings (bits RS0:2) – only settings of 000 (unit does not attempt to restart on fault) and 111 unit continuously restarts (normal startup) while fault is present until commanded off, bias power is removed or another fault condition causes the unit to shutdown. For module code, 4= Auto-restart, 0=Latching mode.
- Delay time setting (bits 0-2) – only DT0:2 = 0 (no delay) supported.

Default Settings: The default settings for the VOUT_OV_FAULT_RESPONSE command are;

- The unit shuts down in response to a VOUT over voltage condition.
- The unit will latch no matter VOUT over voltage condition is present or not, until re-power the unit or just ON/OFF unit by switch.
- The shutdown delay is set to 0 delay cycles.
- Whether the default protection mode should be set or not depends on definition in module code.

Format	8 bit unsigned (bit field)							
Bit Position	7	6	5	4	3	2	1	0
Access	r	r	r/w	r/w	r/w	r	r	r
Function	RSP[1]	RSP[0]	RS[2]	RS[1]	RS[0]	DT[2]	DT[1]	DT[0]
Default Value	1	0	1	1	1	0	0	0

IOUT_OC_FAULT_LIMIT [0x46]

Range limits (max/min): 175/34

Units: amp

Command support: All functionality

Note: Range cross-check – value must be greater than IOUT_OC_WARN_LIMIT value.

IOUT_OC_FAULT_RESPONSE [0x47]

Command support:

- Response settings (bits RSP0:1) – only settings of 11, unit shuts down and responds according to the retry settings below, is supported.
- Retry settings (bits RS0:2) – only settings of 000 (unit does not attempt to restart on fault) and 111 unit continuously restarts (normal startup) while fault is present until commanded off, bias power is removed or another fault condition causes the unit to shutdown. For module code, 4= Auto-restart, 0=Latching mode.
- Delay time setting (bits 0-2) – only DT0:2 = 0 (no delay) supported.

QODE136A0B Technical Specifications (continued)

Summary of Supported PMBus Commands (continued)

Default Settings: The default settings for the IOUT_OC_FAULT_RESPONSE command are;

- The unit shuts down in response to an IOUT over current condition.
- The unit will latch no matter the IOUT over current condition is present, until re-power the unit or just ON/OFF unit by switch
- The shutdown delay is set to 0 delay cycles.
- Whether the default protection mode should be set or not depends on definition in module code.

Format	8 bit unsigned (bit field)							
Bit Position	7	6	5	4	3	2	1	0
Access	r	r	r/w	r/w	r/w	r	r	r
Function	RSP[1]	RSP[0]	RS[2]	RS[1]	RS[0]	DT[2]	DT[1]	DT[0]
Default Value	1	1	1	1	1	0	0	0

IOUT_OC_WARN_LIMIT [0x4A]

Range limits (max/min): 170/25

Units: amp

Command support: read/write support, functionality complete

Note: Range cross-check – value must be less than IOUT_OC_FAULT_LIMIT value.

OT_FAULT_LIMIT [0x4F]

Range limits (max/min): 120/25

Units: degrees C.

Command support: All functionality

Note: Range cross-check – value must be greater than OT_WARN_LIMIT value.

OT_FAULT_RESPONSE [0x50]

Command support:

- Response settings (bits RSP0:1) – only setting of 10, unit shuts down and responds according to the retry settings below.
- Retry settings (bits RS0:2) – only settings of 000 (unit does not attempt to restart on fault) and 111 unit continuously restarts (normal startup) while fault is present until commanded off, bias power is removed or another fault condition causes the unit to shutdown.
- Delay time setting (bits 0-2) – only DT0:2 = 0 (no delay) supported.

Default Settings: The default settings for the OT_FAULT_RESPONSE command are;

- The unit shuts down in response to an over-temperature condition.
- The unit will continuously restart (normal startup) while the over-temperature condition is present until it is commanded off, bias power is removed or another fault condition causes the unit to shutdown.
- The shutdown delay is set to 0 delay cycles.

Format	8 bit unsigned (bit field)							
Bit Position	7	6	5	4	3	2	1	0
Access	r	r	r/w	r/w	r/w	r	r/w	r
Function	RSP[1]	RSP[0]	RS[2]	RS[1]	RS[0]	DT[2]	DT[1]	DT[0]
Default Value	1	0	1	1	1	0	0	0

QODE136A0B Technical Specifications (continued)

Summary of Supported PMBus Commands (continued)

OT_WARN_LIMIT [0x51]

Range limits (max/min): 115/25

Units: degrees C.

Command support: All functionality

Note: Range cross-check – value must be less than OT_FAULT_LIMIT value.

VIN_OV_FAULT_LIMIT [0x55]

Range limits (max/min): 65/48

Units: volt

Command support: All functionality

POWER_GOOD_ON [0x5E]

Range limits (max/min): 11.7/9.2

Units: volt

Command support: full support

Note: Range cross-check – value must be greater than POWER_GOOD_OFF value by 0.5V.

POWER_GOOD_OFF [0x5F]

Range limits (max/min): 10.1/7.6

Units: volt

Command support: full support

Note: Range cross-check – value must be less than POWER_GOOD_ON value by 0.5V.

TON_DELAY [0x60]

Range limits (max/min): 500/0

Units: milliseconds

Command support: full support

TON_RISE [0x61]

Range limits (max/min): 500/12

Units: milliseconds

Command support: full support

QODE136A0B Technical Specifications (continued)

Summary of Supported PMBus Commands (continued)

STATUS_WORD [0x79]

Command support: full implementation for supported functions.
(note: Fans, MFR_SPECIFIC, Unknown not supported).

Format		8 bit unsigned (bit field)						
Bit Position	15	14	13	12	11	10	9	8
Access	r	r	r	r	r	r	r	r
Function	VOUT	I/POUT	INPUT	x	#PWR_GOOD	x	x	x

Format		8 bit unsigned (bit field)						
Bit Position	7	6	5	4	3	2	1	0
Access	r	r	r	r	r	r	r	r
Function	x	OUTPUT_OFF	VOUT_OV_FAULT	IOUT_OC_FAULT	VIN_UV_FAULT	TEMP	CML	x

STATUS_VOUT [0x7A]

Command support: VOUT_OV_FAULT support, all bit reset supported.

Format		8 bit unsigned (bit field)						
Bit Position	7	6	5	4	3	2	1	0
Access	r/reset(1)	r/ reset	r/ reset	r/ reset	r/ reset	r/ reset	r/ reset	r/ reset
Function	VOUT_OV_FAULT	x	x	x	x	x	x	x

STATUS_IOUT [0x7B]

Command support: IOUT_OC_FAULT support, all bit reset supported.

Format		8 bit unsigned (bit field)						
Bit Position	7	6	5	4	3	2	1	0
Access	r/ reset(1)	r/ reset	r/ reset	r/ reset	r/ reset	r/ reset	r/ reset	r/ reset
Function	IOUT_OC_FAULT	x	IOUT_OC_WARN	x	x	x	x	x

STATUS_INPUT [0x7C]

Command support: VIN_OV_FAULT support, all bit reset supported.

Format		8 bit unsigned (bit field)						
Bit Position	7	6	5	4	3	2	1	0
Access	r/ reset(1)	r/ reset	r/ reset	r/ reset	r/ reset	r/ reset	r/ reset	r/ reset
Function	VIN_OV_FAULT	VIN_OV_WARN ¹	VIN_UV_WARN ¹	VIN_UV_FAULT	Unit Off (low input voltage)	IIN_OC_FAULT ¹	IIN_OC_WARN ¹	PIN_OP_WARN ¹

QODE136A0B Technical Specifications (continued)

Summary of Supported PMBus Commands (continued)

STATUS_TEMPERATURE [0x7D]

Command support: OT_WARN, OT_FAULT supported, all bit reset supported.

Format		8 bit unsigned (bit field)						
Bit Position	7	6	5	4	3	2	1	0
Access	r/ reset(1)	r/ reset	r/ reset	r/ reset	r/ reset	r/ reset	r/ reset	r/ reset
Function	OT_FAULT	OT_WARN	x	x	x	x	x	x

STATUS_CML [0x7E]

Command support: PEC_FAULT, INVALID_DATA, INVALID_CMD supported, all bit reset supported.

Format		8 bit unsigned (bit field)						
Bit Position	7	6	5	4	3	2	1	0
Access	r/ reset(1)	r/ reset	r/ reset	r/ reset	r/ reset	r/ reset	r/ reset	r/ reset
Function	INVALID_CMD	INVALID_DATA	PEC FAILED	x	x	x	x	x

READ_VIN [0x88]

Command support: full support

READ_VOUT [0x8B]

Command support: full support

READ_IOUT [0x8C]

Command support: full support

READ_TEMPERATURE_1 [0x8D]

Command support: full support

PMBUS_REVISION [0x98]

Command support: full support

*See Table below:

Format		8 bit unsigned (bit field)						
Bit Position	7	6	5	4	3	2	1	0
Access	r	r	r	r	r	r	r	r
Function	Part I Revision			Part II Revision				
Default Value	0	0	1	reserved	0	0	1	0

PMBus Revision Data Byte Contents			
Bits [7:4]	Part I Revision	Bits [3:0]	Part II Revision
0000	1.0	0000	1.0
0001	1.1	0001	1.1
0010	1.2	0010	1.2

QODE136A0B Technical Specifications (continued)

Summary of Supported PMBus Commands (continued)

MFR_DEVICE_TYPE [0xD0]

Command support: partial support in place (Mod Name)

Format		Unsigned Binary																
Bit Pos.		7	6	5	4	3	2	1	0	7	6	5	4	3	2	1	0	
Access		r/w	r/w	r/w	r/w	r/w	r/w	r/w	r/w	r/w	r/w	r/w	r/w	r/w	r/w	r/w	r/w	
Function		Reserved								Module Name							WPE	Res
Default		0	0	0	0	0	0	0	0	0	1	0	1	1	1	1	0	

Byte	Bit	Description	Value	Meaning
High Byte	7:0	Reserved		
Low Byte	7:2	Module Name ¹	0xxxxx	Module Name
	1	WPE	0	Write Protect Enable not active.
			1	Write Protect Enable active.
	0	Reserved	0	Reserved

1. Present module designations (Non-isolated units will have a 0XXXXX format)

- QODE136A0Bxxx: 010111

MFR_VOUT_READ_CAL_GAIN [0xC1]

Factory default: 0x2000

Range limits (max/min): 0x2666/0x1999

Units: N/A

Command support: support for VOUT gain calibration (factor in flash), lockout per MFR_DEVICE_TYPE

MFR_VOUT_READ_CAL_OFFSET [0xC2]

Range limits (max/min): exp must = -12

Units: N/A

Data format: VOUT linear except with a two's complement (signed) mantissa

Command support: support for VOUT offset calibration (factor in flash), lockout per MFR_DEVICE_TYPE

MFR_VIN_READ_CAL_GAIN [0xD3]

Factory default: 0x2000

Range limits (max/min): 0x2666/0x1999

Command support: support for VIN gain calibration (factor in flash), lockout per MFR_DEVICE_TYPE

MFR_VIN_READ_CAL_OFFSET [0xD4]

Data format: VIN linear format

Range limits (max/min): exp must = -3

Units: N/A

Command support: support for IOUT offset calibration, lockout per MFR_DEVICE_TYPE

MFR_IOUT_CAL_GAIN [0xD6]

Range limits (max/min): 0x2666/0x1999

Units: N/A

Command support: support for IOUT gain calibration, lockout per MFR_DEVICE_TYPE

QODE136A0B Technical Specifications (continued)

Summary of Supported PMBus Commands (continued)

MFR_IOUT_CAL_OFFSET [0xD7]

Range limits (max/min): 20/-20

Units: A

Command support: support for IOUT offset calibration, lockout per MFR_DEVICE_TYPE

MFR_FW_REV [0xDB]

Range limits (max/min): 9999/0000

Units: N/A

Command support: full read support

Format: 4 hex characters: Major revision, Minor revision, Build high, Build low (0xMj.Mn.Bh.Bl)

Example: 0x1218 indicates firmware revision 1.2.18.

MFR_FW_REV [0xDB]

Range limits (max/min): 9999/0000

Units: N/A

Command support: full read support

Format: 4 hex characters: Major revision, Minor revision, Build high, Build low (0xMj.Mn.Bh.Bl)

Example: 0x1218 indicates firmware revision 1.2.18.

MFR_PGOOD_POLARITY [0xE2]

Command support: full support (bit 0) as follows:

Bit 0: 0 = Negative PGOOD logic (module PGOOD asserted when pin is LO, PGOOD de-asserted when pin is HI)

1 = Positive PGOOD logic (module PGOOD de-asserted when pin is LO, PGOOD asserted when pin is HI)

Command	MFR_PGOOD_POLARITY							
Format	8 bit unsigned (bit field)							
Bit Position	7	6	5	4	3	2	1	0
Access	r	r	r	r	r	r	r	r/w
Function	Reserved							logic
Default Value	0	0	0	0	0	0	0	1

MFR_MODULE_DATE_LOC_SN [0xF0]

Command support: read/write support for 12 byte block, lockout per MFR_DEVICE_TYPE

QODE136A0B Technical Specifications (continued)

Summary of Supported PMBus Commands (continued)

PMBus Command Quick Reference Table

PMBUS CMD	CMD CODE	DATA BYTES	DATA FORMAT	DATA UNITS	TRANSFER TYPE*	DEFAULT VALUE
OPERATION	0x01	1	Bit field	N/A	R/W byte	0x88
ON_OFF_CONFIG	0x02	1	Bit field	N/A	R/W byte	0x1D (Neg Logic) 0x1F (Pos Logic)
CLEAR_FAULTS	0x03	0	N/A	N/A	Send byte	none
WRITE_PROTECT	0x10	1	Bit field	N/A	R/W byte	0x00
STORE_DEFAULT_ALL	0x11	0	N/A	N/A	Send byte	none
RESTORE_DEFAULT_ALL	0x12	0	N/A	N/A	Send byte	none
CAPABILITY	0x19	1	Bit field	N/A	Read byte	0xB0
VOUT_MODE	0x20	1	mode + exp	N/A	Read byte	0x14
VOUT_COMMAND	0x21	2	VOUT linear	Volts	R/W word	12.0V (Std code)
VOUT_CAL_OFFSET	0x23	2	VOUT linear	Volts	R/W word	MS
VOUT_MARGIN_HIGH	0x25	2	VOUT linear	Volts	R/W word	12.000V
VOUT_MARGIN_LOW	0x26	2	VOUT linear	Volts	R/W word	11.400V
VOUT_DROOP	0x28	2	linear	mV/A	R/W word	0 (without -P) 2.9 (with -P)
VIN_ON	0x35	2	linear	V	R/W word	37V
VIN_OFF	0x36	2	linear	V	R/W word	35V
VOUT_OV_FAULT_LIMIT	0x40	2	VOUT linear	V	R/W word	14V
VOUT_OV_FAULT_RESPONSE	0x41	1	Bit field	N/A	R/W byte	0XB8
IOUT_OC_FAULT_LIMIT	0x46	2	linear	Amps	R/W word	160A
IOUT_OC_FAULT_RESPONSE	0x47	1	Bit field	N/A	R/W byte	0XF8
IOUT_OC_WARN_LIMIT	0x4A	2	linear	Amps	R/W word	155A
OT_FAULT_LIMIT	0x4F	2	linear	Deg. C	R/W word	110C
OT_FAULT_RESPONSE	0x50	1	Bit field	N/A	R/W byte	0xB8
OT_WARN_LIMIT	0x51	2	linear	Deg. C	R/W word	105C
VIN_OV_FAULT_LIMIT	0x55	2	linear	V	R/W word	63V
POWER_GOOD_ON	0x5E	2	VOUT linear	V	R/W word	11.4V
POWER_GOOD_OFF	0x5F	2	VOUT linear	V	R/W word	9.8V
TON_DELAY	0x60	2	linear	msec	R/W word	0ms
TON_RISE	0x61	2	linear	msec	R/W word	15ms (without -P) 15ms (with -P)
STATUS_WORD	0x79	2	Bit field	N/A	Read word	N/A
STATUS_VOUT	0x7A	1	Bit field	N/A	Read byte	N/A
STATUS_IOUT	0x7B	1	Bit field	N/A	Read byte	N/A
STATUS_INPUT	0x7C	1	Bit field	N/A	Read byte	N/A
STATUS_TEMPERATURE	0x7D	1	Bit field	N/A	Read byte	N/A
STATUS_CML	0x7E	1	Bit field	N/A	Read byte	N/A
READ_VIN	0x88	2	linear	v	Read word	N/A
READ_VOUT	0x8B	2	VOUT linear	v	Read word	N/A
READ_IOUT	0x8C	2	linear	Amps	Read word	N/A
READ_TEMP1	0x8D	2	linear	Deg. C	Read word	N/A
PMBUS_REVISION	0x98	1	Bit Field	n/a	Read byte	1.2
MFR_ID	0x99	5	8-bit char	N/A	Read block	OMPW
MFR_MODEL	0x9A	18	8-bit char	N/A	Read block	N/A
MFR_REVISION	0x9B	8	8-bit char	N/A	Read block	N/A
MFR_LOCATION	0x9C	12	8-bit char	N/A	Read block	N/A
MFR_DATE	0x9D	6	8-bit char	N/A	Read block	N/A
MFR_SERIAL	0x9E	18	8-bit char	N/A	Read block	N/A
MFR_VOUT_READ_CAL_GAIN	0xC1	2	16 bit unsigned	N/A	R/W word	0x2000

QODE136A0B Technical Specifications (continued)

Summary of Supported PMBus Commands (continued)

PMBus Command Quick Reference Table (continued)

PMBUS CMD	CMD CODE	DATA BYTES	DATA FORMAT	DATA UNITS	TRANSFER TYPE*	DEFAULT VALUE
MFR_VOUT_READ_CAL_OFFSET	0xC2	2	mod VOUT linear	N/A	R/W word	MS
MFR_DEVICE_TYPE	0xD0	2	Custom	N/A	R/W word	0x005E
MFR_VIN_READ_CAL_GAIN	0xD3	2	16 bit unsigned	N/A	R/W word	MS
MFR_VIN_READ_CAL_OFFSET	0xD4	2	linear	N/A	R/W word	MS
MFR_IOUT_CAL_GAIN	0xD6	2	16 bit unsigned	N/A	R/W word	MS
MFR_IOUT_CAL_OFFSET	0xD7	2	linear	N/A	R/W word	MS
MFR_FW_REV	0xDB	2	16 bit unsigned	N/A	Read word	current version
MFR_PGOOD_POLARITY	0xE2	1	Bit field	N/A	R/W byte	0x01
MFR_MOD_DATE_LOC_SN	0xF0	12	8 bit char	N/A	R/W block	YYLLWW123456

*Some Write commands are ignored until Write Protection is disabled using the MFR_DEVICE_TYPE (0xD0) command. These are identified by "lockout per MFR_DEVICE_TYPE" in the preceding detailed command descriptions.

Note: Customer should not update registers, which are related to protection (OCP, UVP, OVP), if those registers need to be updated please contact your OmniOn Power™ Field Application Engineer

QODE136A0B Mechanical Specifications

Mechanical Outline

Dimensions are in millimeters and [inches].

Tolerances: x.x mm ± 0.5 mm [x.xx in. ± 0.02 in.] (Unless otherwise indicated)

x.xx mm ± 0.25 mm [x.xxx in ± 0.010 in.]

TOP VIEW

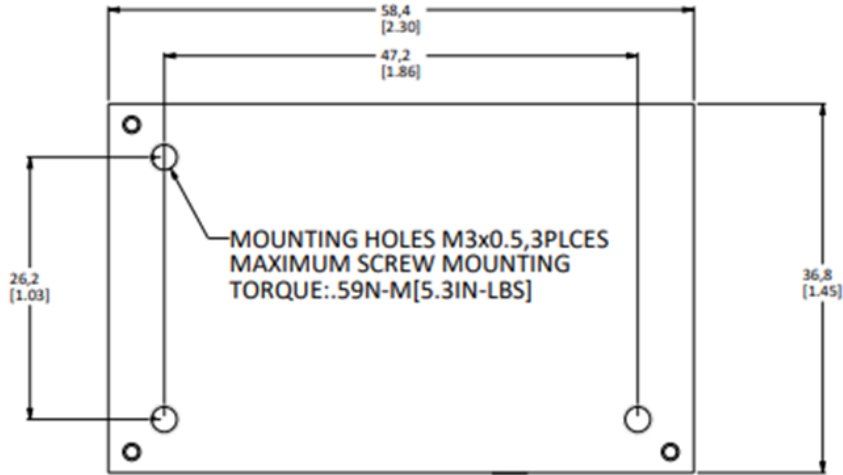

SIDE VIEW



BOTTOM VIEW

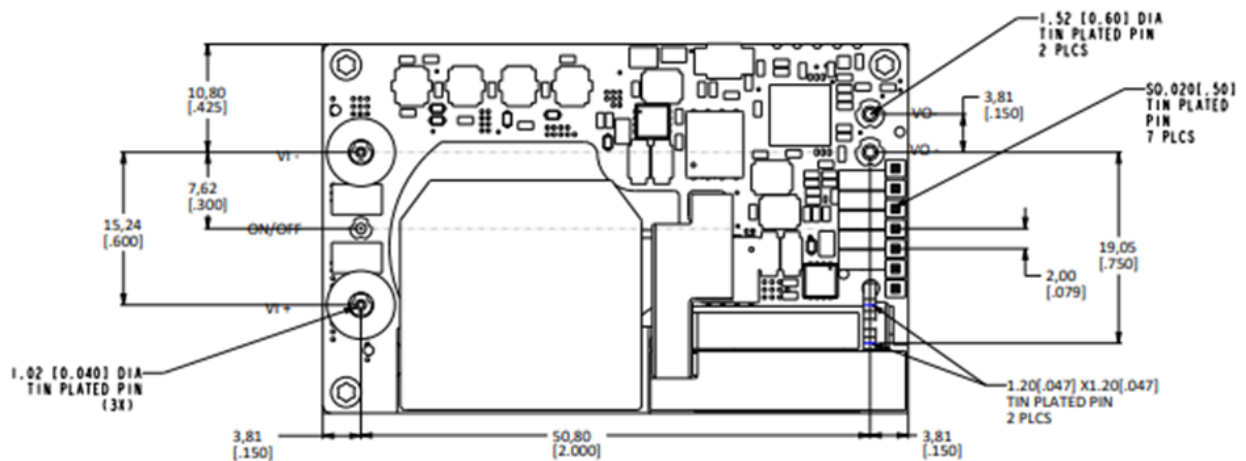

QODE136A0B Mechanical Specifications (continued)

Recommended Pad Layouts

Dimensions are in millimeters and (inches).

Tolerances: x.x mm ± 0.5 mm [x.xx in. ± 0.02 in.] (unless otherwise indicated)

x.xx mm ± 0.25 mm [x.xxx in ± 0.010 in.]

PIN configuration is shown below.

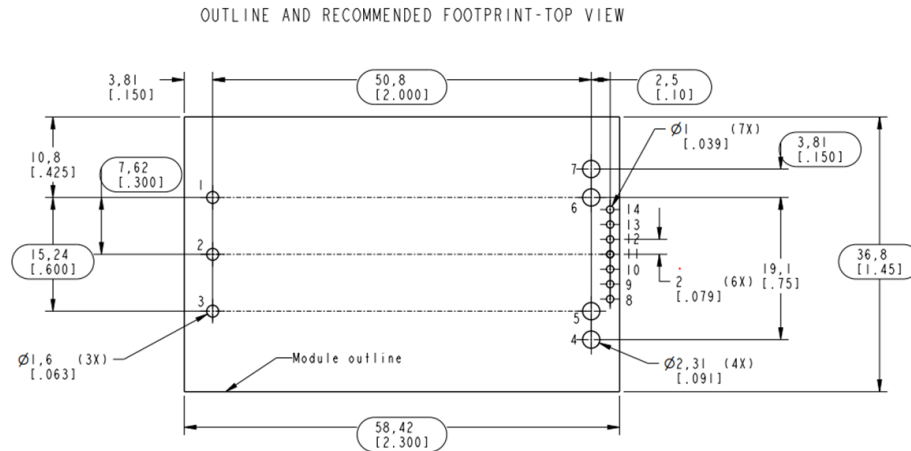

Pin Number	Pin Name	Pin Number	Hole Dia mm [in]	Pad Dia mm [in]
1	VIN(+)	1, 2, 3	1.6 [.063]	2.1 [.083]
2	ON/OFF	8, 9, 10, 11, 12, 13, 14	1.0 [.039]	1.5 [.059]
3	VIN(-)	4, 5, 6, 7	2.3 [.091]	3.3 [.130]
4	VOUT(-)			
5	VOUT(-)			
6	VOUT(+)			
7	VOUT(+)			
8	PG			
9	SENSE-			
10	SDA			
11	SALERT			
12	SCL			
13	ADDR1			
14	SENSE+			

- Heatsink mounting holes: 3 required, M3, 110mil min screw penetration, 3 thread engagement, 5.3 in-lbs., cct protected from metal shavings [c]

Packaging Details

QODE136A0B (with base plate) are supplied as standard in the plastic trays shown in figure 22.

Tray Specification

Material	PET(1.2mm)
Max surface resistivity	10 ⁵ -10 ¹¹ Ω/PET
Color	Clear
Capacity	12 power modules
Min order quantity	24 pcs (1 box of 2 full trays + 1 empty top cover tray)

Each tray contains a total of 12 power modules. The trays are self-stacking and each shipping box for the QODE136A0B module contains 2 full trays plus one empty hold-down tray giving a total number of 24 power modules.

QODE136A0B Mechanical Specifications (continued)

Recommended Pad Layouts (continued)

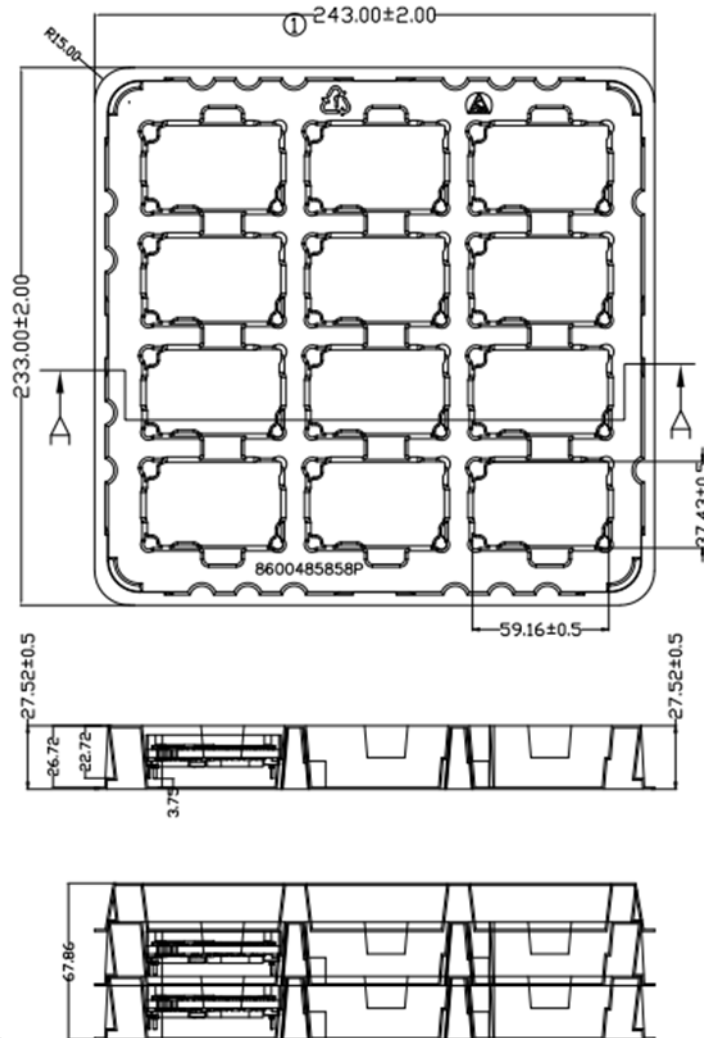

Figure 22. QODE136A0B Packaging Tray

QODE136A0B Ordering Information

Table 1: Device Codes [stocked codes in boldface]

Product Codes	Input Voltage	Output Voltage	Output Current	Efficiency	Connector Type	MSL Rating	Ordering Code
QODE136A0B41-HZ	54V (40-60V _{DC})	12V	136A	97.3%	Through hole	2a	1600483940A
QODE136A0B41-PHZ							1600484837A
QODE136A0B41-AHZ							1600487276A
QODE136A0B641-HZ							1600486249A
QODE136A0B641-PHZ							1600486971A
QODE136A0B541-HZ							1600487214A
QODE136A0B541-PHZ							1600487216A
QODE136A0B541-AHZ							1600487277A
QODE136A0B841-HZ							1600487213A
QODE136A0B841-PHZ							1600487215A

Table 2: Device Options

Characteristic	Character and Position										Definition	
Form Factor	Q											Q = Quarter Brick
Family Designator		OD										OD = OSPREY Digital Series with PMBus Interface
Input Voltage			E									E = Expanded, 40V - 60V
Output Power				136A0								136A0 = 136.0A Rated Output Current
Output Voltage					B							B = 12V nominal
Pin Length						8	6	5				Omit = Default Pin Length shown in Mechanical Outline (6.35 mm) 8 = Pin Length: 2.79 mm ± 0.25mm, (0.110 in. ± 0.010 in.) 6 = Pin Length: 3.68 mm ± 0.25mm, (0.145 in. ± 0.010 in.) 5 = Pin length: 4.57 mm ± 0.25mm, (0.180 in. ± 0.010 in.)
Action following Protective Shutdown							4					Omit = Latching Mode 4 = Auto-restart following shutdown (Overcurrent/Overvoltage)
On/off Logic							1					Omit = Positive Logic 1 = Negative Logic
									-			
Load share										P		P = Forced Droop Output for use in parallel applications
										A		A = Active current share for use in parallel applications
Heat Plate											H	H = Heat plate, for use with a heat sink or cold wall
RoHS											Z	Z = RoHS Compliant

Change History (excludes grammar & clarifications)

Revision	Date	Description of the change
1.0	01/21/2025	Initial release
1.1	01/29/2025	EMI updated

OmniOn Power Inc.

601 Shiloh Rd.
Plano, TX USA

omnionpower.com

We reserve the right to make technical changes or modify the contents of this document without prior notice. OmniOn Power™ does not accept any responsibility for errors or lack of information in this document and makes no warranty with respect to and assumes no liability as a result of any use of information in this document.

We reserve all rights in this document and in the subject matter and illustrations contained therein. Any reproduction, disclosure to third parties or utilization of its contents – in whole or in parts – is forbidden without prior written consent of OmniOn Power™. This document does not convey license to any patent or any intellectual property right. Copyright© 2025 OmniOn Power Inc. All rights reserved.