

DATASHEET

QBVS128A0B : Barracuda* DC-DC Converter

48 to 60V_{DC} input; 12V_{DC} output; 128A output current

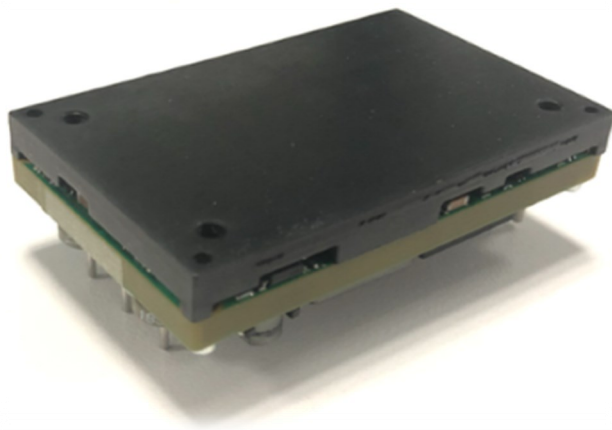

RoHS Compliant

The QBVS128A0B Barracuda™ series of dc-dc converters is a new generation of fully regulated DC/DC power modules designed to support 12Vdc intermediate bus applications. The QBVS128A0B series operate from an input voltage range of 48 to 60Vdc and provide up to 1540W output power in an industry-standard, modified DOSA analog quarter brick. The converter incorporates digital control, synchronous rectification technology, a fully regulated control topology, and innovative packaging techniques to achieve full load efficiency exceeding 97% at 12dc output. Standard features include a heat plate to attach external heat sinks or contact a cold wall, on/off control, output overcurrent and over voltage protection, over temperature protection, input under and over voltage lockout. The output is fully isolated from the input, allowing versatile polarity configurations and grounding connections.

Application

- Distributed power architectures
- Intermediate bus voltage applications
- Networking equipment
- Servers and storage applications
- Supercomputers
- Automatic Test Equipment

Features

- Compliant to RoHS Directive 2011/65/EU and amended Directive (EU) 2015/863
- Compliant to REACH Directive (EC) No 1907/2006
- High and flat efficiency with peak efficiency 97%
- Input voltage range: 48-60Vdc
- Delivers up to 1540W output power
- Low output ripple and noise
- Industry standard, modified-DOSA Digital Quarter Brick: 58.4mm x 36.8mm x 14.5 mm (2.30in x 1.45in x 0.57in)
- Constant switching frequency
- Remote On/Off control
- Output over current/voltage protection
- Over temperature protection
- Pre-bias startup
- Wide operating temperature range: -5°C to 85°C, continuous
- ANSI/UL# 62368-1 and CAN/CSA† C22.2 No. 62368-1 Recognized, DIN VDE‡ 0868-1/A11:2017 (EN62368-1:2014/A11:2017)
- ISO** 9001 and ISO 14001 certified manufacturing facilities
- Base plate (-H=option code, always required)
- Class II, Category 2, Isolated DC/DC Converter (IPC-9592B)

* UL is a registered trademark of Underwriters Laboratories, Inc.

† CSA is a registered trademark of Canadian Standards Association.

‡ VDE is a trademark of Verband Deutscher Elektrotechniker e.V.

** ISO is a registered trademark of the International Organization of Standards # The PMBus name and logo are registered trademarks of the System Management Interface Forum (SMIF)

QBVS128A0B Technical Specifications

Absolute Maximum Ratings

Stresses in excess of the absolute maximum ratings can cause permanent damage to the device. These are absolute stress ratings only, functional operation of the device is not implied at these or any other conditions in excess of those given in the operations sections of the data sheet. Exposure to absolute maximum ratings for extended periods can adversely affect the device reliability.

Parameter	Symbol	Min	Max	Unit
Input Voltage ¹				
Continuous	V_{IN}	-0.3	60	V_{dc}
$V_{ON/OFF}$ to $V_{IN}(-)$	$V_{ON/OFF}$	–	14.5	V_{dc}
ADDR to $V_{out}(-)$		-0.5	3.8	V
Operating Ambient Temperature				
Long-Term Operating	T_A	-5	85	°C
Storage Temperature	T_{stg}	-40	125	°C
I/O Isolation Voltage ² (100% factory Hi-Pot tested)	–	–	750	V_{dc}

¹ Input over voltage protection will shutdown the output voltage when the input voltage exceeds threshold level.

² Base plate is considered floating.

Electrical Specifications

Unless otherwise indicated, specifications apply overall operating input voltage, resistive load, and temperature conditions.

Parameter	Device	Symbol	Min	Typ	Max	Unit
Operating Input Voltage		V_{IN}	48	54	60	V_{dc}
Maximum Input Current ($V_{IN}=48V$, $I_O=I_{O,max}$)		$I_{IN,max}$	–	–	34	A_{dc}
Input No Load Current ($V_{IN} = V_{IN,nom}$, $I_O = 0A$, module enabled)	All	$I_{IN, No load}$		200		mA

Technical Specifications (continued)

Parameter	Device	Symbol	Min	Typ	Max	Unit
Input Stand-by Current ($V_{IN} = V_{IN,nom}$, module disabled)	All	$I_{IN, stand-by}$			70	mA
External Input Capacitance	All		260	–	1300	μ F
Inrush Current (Inrush Current is defined as the peak current drawn by the unit when unit is enabled after V_{in} is present. I_{in} is defined as the steady-state operating current when unit is operating at V_{in} Max and P_{out} Max. While V_{out} is rising, P_{out} is $\leq 25\%$ of P_{out} Max with a resistive load)	All		–	–	50	% of I_{in}
Input Terminal Ripple Current (Measured at module input pin with maximum specified input capacitance and $< 500\mu$ H inductance between voltage source and input capacitance) 5Hz to 20MHz, $V_{IN} = 54V$, $I_O = I_{O,max}$	All		–	1540	–	mA_{rms}
Input Ripple Rejection (120Hz)	All		–	25	–	dB
Output Voltage Set-point ($V_{IN} = 54V$, $I_O = 64A$, $T_A = 25^\circ C$)	All	$V_{O,set}$	11.88	12	12.12	V_{dc}
Output Voltage (Over all operating input voltage (48V to 60V), resistive load, and temperature conditions until end of life)	All	V_O	11.2	12	12.36	V_{dc}
Output Voltage (Over all operating input voltage (52V to 60V), resistive load, and temperature conditions until end of life)	All	V_O	11.64	12	12.36	V_{dc}
Output Regulation [$V_{IN,min} = 52V$]						
Line ($V_{IN} = V_{IN,min}$ to $V_{IN,max}$)	All		–	0.5	–	% $V_{O,set}$
Load ($I_O = I_{O,min}$ to $I_{O,max}$)	All		–	0.5	–	% $V_{O,set}$
Temperature ($T_A = -5^\circ C$ to $+85^\circ C$)	All		–	2	–	% $V_{O,set}$

Technical Specifications (continued)

Parameter	Device	Symbol	Min	Typ	Max	Unit
Output Ripple and Noise, $C_O=1540 \mu\text{F}$, $\frac{1}{2}$ Ceramic, $\frac{1}{2}$ PosCap or Oscon ($V_{IN} = V_{IN,nom}$ and $I_O=I_{O,min}$ to $I_{O,max}$) RMS (5Hz to 20MHz bandwidth) Peak-to-Peak (5Hz to 20MHz bandwidth)	All		–	50	–	mV_{rms} $\text{mV}_{\text{pk-pk}}$
External Output Capacitance (Typically 50% ceramic, 50% Oscon or POSCAP)	All	$C_{O,max}$	0	–	15000	μF
Output Power	All	P_O	0	–	1540	W
Output Current	All	I_O	0	–	128.3	A
VOUT_OC_FAULT_LIMIT	All	$I_{O,lim}$	–	150	–	A_{dc}
Efficiency ($V_{IN} = 54\text{V}$, $T_A = 25^\circ\text{C}$) $I_O=100\% I_{O,max}$, $V_O= V_{O,set}$ $I_O=50\% I_{O,max}$ to $80\% I_{O,max}$, $V_O= V_{O,set}$ $I_O=65\% I_{O,max}$, $V_O= V_{O,set}$, Peak efficiency	All All All	η η η		97 97.3 97.4		% % %
Switching Frequency (Primary FETs)		fsw		160		kHz
Dynamic Load Response $di_O/dt=1\text{A}/\mu\text{s}$; $V_{in}=V_{in,nom}$; $T_A=25^\circ\text{C}$; (Tested with a $1.0\mu\text{F}$ ceramic, and $6160\mu\text{F}$ low ESR Polymer capacitor at the load) Load Change from $I_O = 50\%$ to 75% of $I_{O,max}$: Peak Deviation Settling Time ($V_O < 10\%$ peak deviation) Load Change from $I_O = 75\%$ to 50% of $I_{O,max}$: Peak Deviation Settling Time ($V_O < 10\%$ peak deviation)	All All All	V_{pk} t_s V_{pk} t_s	— — — —	350 300 350 300	— — — —	mV_{pk} μs mV_{pk} μs

Technical Specifications (continued)

Isolation Specifications

Parameter	Symbol	Min	Typ	Max	Unit
Isolation Capacitance	C_{iso}	–	10	–	nF
Isolation Resistance	R_{iso}	10	–	–	M Ω

General Specifications

Parameter	Device	Symbol	Typ	Unit
Calculated Reliability Based upon Telcordia SR-332 Issue 3: Method I, Case 3, (IO=80% $I_{o,max}$, Tc=40°C, Airflow = 200 LFM), 90% confidence	All	MTBF	7,391,717	Hours
	All	FIT	135	10 ⁹ /Hours
Weight – with Base plate			90.2(3.2)	g (oz.)

Feature Specifications

Unless otherwise indicated, specifications apply overall operating input voltage, resistive load, and temperature conditions. See Feature Descriptions for additional information.

Parameter	Device	Symbol	Min	Typ	Max	Unit
Remote On/Off Signal Interface ($V_{IN}=V_{IN,min}$ to $V_{IN,max}$, Signal referenced to V_{IN-} terminal) Negative Logic (“1” device code suffix): Logic Low = module On; Logic High = module Off Positive Logic (no device code suffix): Logic Low = module Off; Logic High = module On Logic Low (pull down to $V_{IN(-)}$ externally) Voltage Sink current Logic High (default; pulled up internally) Internal pull-up voltage Optional external applied voltage Leakage current of external pull-down device ($V_{on/off} = 2.4V$)	All	$V_{on/off}$	–	–	0.8	Vdc
	All	$I_{on/off}$	–	–	500	μA
	All	$V_{on/off}$	2.4	–	–	Vdc
	All	$V_{on/off}$	2.4	–	14.5	Vdc
	All	$I_{on/off}$	–	–	130	μA

Technical Specifications (continued)

Parameter	Device	Symbol	Min	Typ	Max	Unit
Turn-On Delay and Rise Times ($I_o=I_{o,max}$, Adjustable via PMBus) T_{delay} =Time until V_o begin start up from either application of V_{in} with Remote On/Off set to On (Enable with V_{in}); or operation of Remote On/Off from Off to On with V_{in} already applied for at least 30 milli-seconds (Enable with on/off).	All	$T_{delay,}$ Enable with V_{in} $T_{delay,}$ Enable with on/off	- -	- -	30 5	ms ms
T_{rise} =Time for V_o to rise from 10% to 90% of $V_{o,set}$,	All	T_{rise}	-	15	-	ms
Over shoot at turn on					350	mV
Under shoot at turn off					350	mV
VOUT_OV_FAULT_LIMIT	All	$V_{o,limit}$	-	$V_{o,set} + 3V$	-	V_{dc}
Overtemperature Protection	All	$T_{OTP,set}$	-	128	-	°C
Input Undervoltage Lockout						
Turn-on Threshold			-	47	-	V_{dc}
Turn-off Threshold			-	43	-	V_{dc}
Hysteresis			2			V_{dc}
Input Overvoltage Lockout						
Turn-off Threshold [VIN_OV_FAULT_LIMIT]			-	62	-	V_{dc}
Turn-on Threshold			60		-	V_{dc}

Technical Specifications (continued)

Characteristic Curves, 12Vdc Output

The following figures provide typical characteristics for the QBVS128A0B (12V, 128A) at 25°C. The figures are identical for either positive or negative Remote On/Off logic.

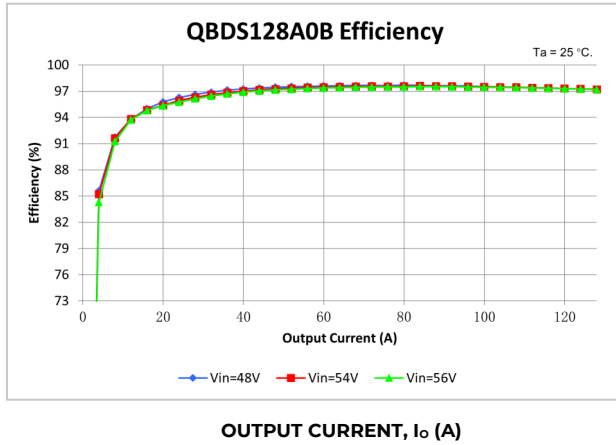

Figure 1. Converter Efficiency versus Output Current.

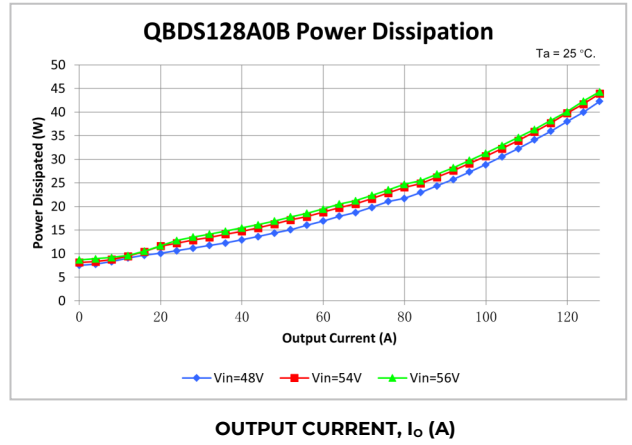

Figure 2. Derating Output Current versus Ambient Temperature and Airflow.

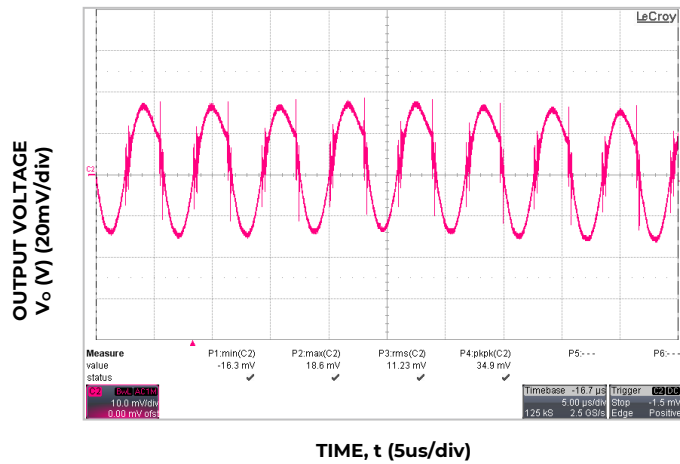

Figure 3. Typical output ripple and noise (Co = 650uF Ceramic + 650uF PosCap Oscon, Vin = 54V, Io = Io,max.).

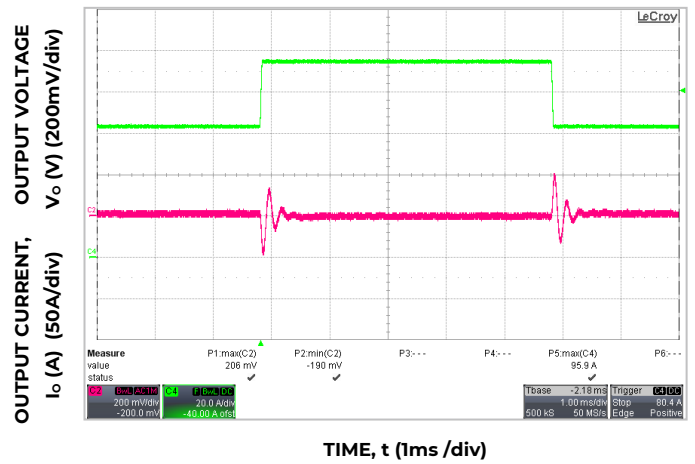

Figure 4. Dynamic Load Response, dIo/dt=1A/us; Vin=Vin,nom; TA=25°C; Load Change from Io = 50% to 75% of Io,max; Co = 6160uF Ceramic;

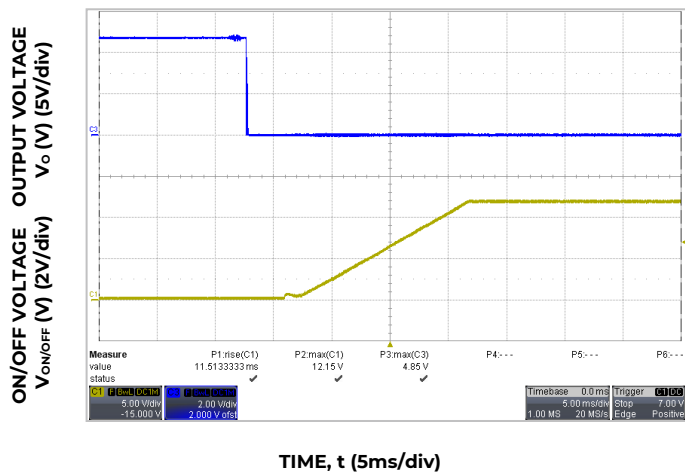

Figure 5. Typical Start-up Using On/Off Voltage (Io = Io,max.).

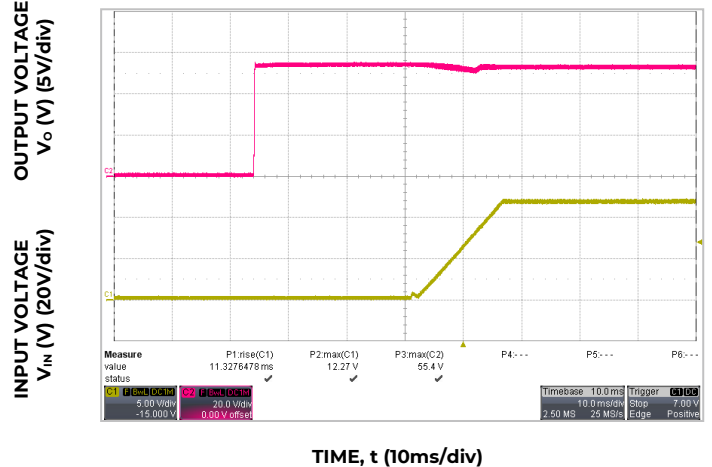

Figure 6. Typical Start-up Using Input Voltage (Vin = 54V, Io = Io,max.).

Technical Specifications (continued)

Characteristic Curves, 12Vdc Output

The following figures provide typical characteristics for the QBVS128A0B (12V, 128A) at 25°C. The figures are identical for either positive or negative Remote On/Off logic.

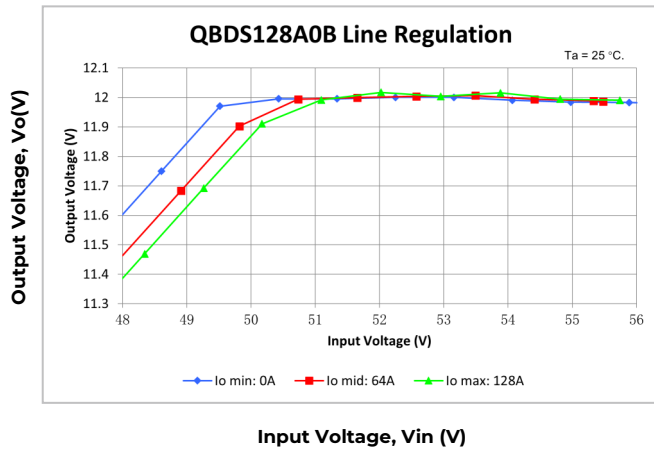

Figure 7. Typical Output Voltage Regulation vs Input Voltage

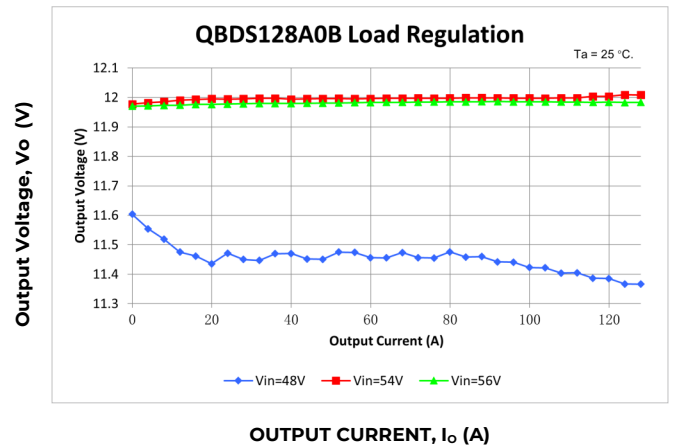
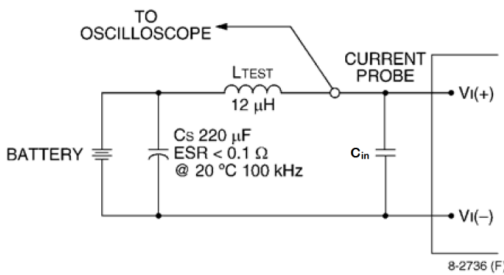

Figure 8. Typical Output Voltage Regulation vs Output Current

Test Configurations



Note: Measure input reflected-ripple current with a simulated source inductance (LTEST) of 12 μH. Capacitor CS offsets possible battery impedance. Measure current as shown above.

Figure 9. Input Reflected Ripple Current Test Setup.

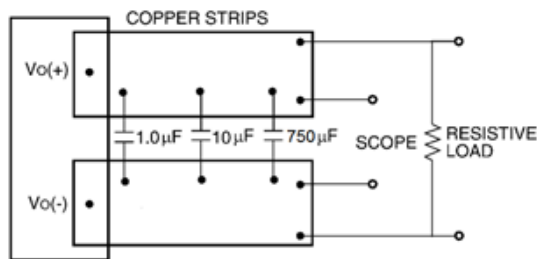

Note: Use a 1.0 μF ceramic capacitor, a 10 μF aluminum or tantalum capacitor and a 750 polymer capacitor. Scope measurement should be made using a BNC socket. Position the load between 51 mm and 76 mm (2 in. and 3 in.) from the module.

Figure 10. Output Ripple and Noise Test Setup.

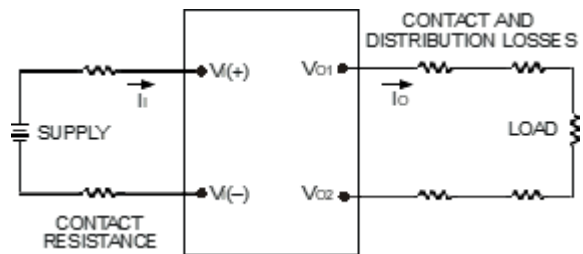

Note: All measurements are taken at the module terminals. When socketing, place Kelvin connections at module terminals to avoid measurement errors due to socket contact resistance.

$$\eta = \left(\frac{[V_{O(+)} - V_{O(-)}] I_O}{[V_{I(+)} - V_{I(-)}] I_I} \right) \times 100 \%$$

Figure 11. Output Voltage and Efficiency Test Setup.

Design Considerations

Input Source Impedance

The power module should be connected to a low ac-impedance source. Highly inductive source impedance can affect the stability of the power module. For the test configuration in Figure 13, a 660μF electrolytic capacitor, C_{in}, (ESR<0.7W at 100kHz), mounted close to the power module helps ensure the stability of the unit.

Technical Specifications (continued)

Safety Considerations

For safety-agency approval of the system in which the power module is used, the power module must be installed in compliance with the spacing and separation requirements of the end-use safety agency standard, i.e., UL60950-1 2nd Ed., CSA C22.2 No. 60950-1 2nd Ed., and VDE0805-1 EN60950-1 2nd Ed.

If the input source is non-SELV (ELV or a hazardous voltage greater than 60 Vdc and less than or equal to 75Vdc), for the module's output to be considered as meeting the requirements for safety extra-low voltage (SELV), all of the following must be true:

The input source is to be provided with reinforced insulation from any other hazardous voltages, including the ac mains.

One VIN pin and one VOUT pin are to be grounded, or both the input and output pins are to be kept floating.

The input pins of the module are not operator accessible.

Another SELV reliability test is conducted on the whole system (combination of supply source and subject module), as required by the safety agencies, to verify that under a single fault, hazardous voltages do not appear at the module's output.

Note: Do not ground either of the input pins of the module without grounding one of the output pins. This may allow a non-SELV voltage to appear between the output pins and ground.

The power module has safety extra-low voltage (SELV) outputs when all inputs are SELV.

The input to these units is to be provided with a maximum 30A fast-acting (or time-delay) fuse in the ungrounded input lead.

Feature Descriptions

Overcurrent Protection

To provide protection in a fault output overload condition, the module is equipped with internal current-limiting circuitry and can endure current limiting continuously. If the overcurrent condition causes the output voltage to fall greater than 3.0V from $V_{o,set}$, the module will shut down and remain latched off. The overcurrent latch is reset by either cycling the input power or by toggling the on/off pin for one second. If the output overload condition still exists when the module restarts, it will shut down again. This operation will continue indefinitely until the overcurrent condition is corrected.

A factory configured auto-restart option (with overcurrent and overvoltage auto-restart managed as a group) is also available. An auto-restart feature continually attempts to restore the operation until fault condition is cleared.

Remote ON/OFF

The module contains a standard on/off control circuit reference to the VIN(-) terminal. Two factory configured remote on/off logic options are available. Positive logic remote on/off turns the module on during a logic-high voltage on the ON/OFF pin, and off during a logic low. Negative logic remote on/off turns the module off during a logic high, and on during a logic low. Negative logic, device code suffix "1," is the factory-preferred configuration.

The On/Off circuit is powered from an internal bias supply, derived from the input voltage terminals. To turn the power module on and off, the user must supply a switch to control the voltage between the On/Off terminal and the VIN(-) terminal ($V_{on/off}$). The switch can be an open collector or equivalent (see Figure 16). The switch should maintain $<0.8V$ while sinking up to $200\mu A$. During a logic high when the switch is off, the maximum allowable leakage current at $V_{on/off} = 2.4V$ is $130\mu A$. If using an external voltage source, the maximum voltage $V_{on/off}$ on the pin is 14.5V with respect to the VIN(-) terminal.

If not using the remote on/off feature, perform one of the following to turn the unit on:

For negative logic, short ON/OFF pin to VIN(-).

For positive logic: leave ON/OFF pin open.

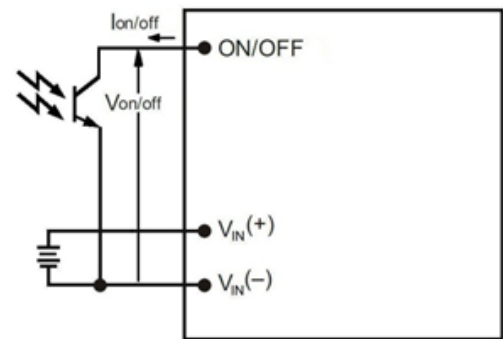

Figure 12. Remote On/Off Implementation.

Technical Specifications (continued)

Output Overvoltage Protection

The module contains circuitry to detect and respond to output overvoltage conditions. If the overvoltage condition causes the output voltage to rise above the limit in the Specifications Table, the module will shut down and remain latched off. The overvoltage latch is reset by either cycling the input power, or by toggling the on/off pin for one second. If the output overvoltage condition still exists when the module restarts, it will shut down again. This operation will continue indefinitely until the overvoltage condition is corrected.

A factory configured auto-restart option (with overcurrent and overvoltage auto-restart managed as a group) is also available. An auto-restart feature continually attempts to restore the operation until fault condition is cleared.

Overtemperature Protection

These modules feature an overtemperature protection circuit to safeguard against thermal damage. The circuit shuts down the module when the maximum device reference temperature is exceeded. The module will automatically restart once the reference temperature cools by $\sim 25^{\circ}\text{C}$.

Input Under/Over voltage Lockout

At input voltages above or below the input under/over voltage lockout limits, module operation is disabled. The module will begin to operate when the input voltage level changes to within the under and overvoltage lockout limits. However recovery from input undervoltage may be delayed by 4 seconds, or 13 seconds if the module is hot.

Power Good, PG (option)

The QBVS128A0B module provides a Power Good (PG) option, which compares the module's output voltage to the module's POWER_GOOD_ON and POWER_GOOD_OFF values. These values are adjustable via PMBus. PG is asserted when the module's output voltage is above the POWER_GOOD_ON value, and PG is de-asserted if any condition such as overtemperature, overcurrent or loss of regulation occurs that would result in the output voltage going below the POWER_GOOD_OFF value.

The PG signal, provided on pin C2, is implemented with an open-drain node, pulled up via a 10k Ω resistor to 3.3V internally. For Positive Logic PG (default), the PG signal is HI, when PG is asserted, and LO, when the PG is de-asserted. For Negative Logic PG, the PG signal is LO, when PG is asserted, and HI, when the PG is de-asserted.

The PMBus command MFR_PGOOD_POLARITY is used to set the logic polarity of the signal.

If not using the Power Good feature, the pin may be left N/C.

Default code is w/o PG pin.

Please contact OmniOn representative for this option

Thermal Considerations

The power modules operate in a variety of thermal environments and sufficient cooling should be provided to help ensure reliable operation. Thermal considerations include ambient temperature, airflow, module power dissipation, and the need for increased reliability. A reduction in the operating temperature of the module will result in an increase in reliability. Heat-dissipating components are mounted on the top side of the module. Heat is removed by conduction, convection and radiation to the surrounding environment. Proper cooling can be verified by measuring the thermal reference temperature (TH1).

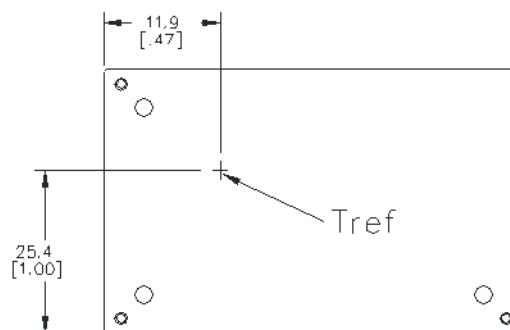

Figure 13. Location of the thermal reference temperature TH1 for base plate module.

Peak temperature occurs at the position indicated in Figure 13. For reliable operation, this temperature should not exceed TH1=115 $^{\circ}\text{C}$ at any airflow condition. For extremely high reliability you can limit this temperature to a lower value. The output power of the module should not exceed the rated power for the module as listed in the Ordering Information table, or the derated power for the actual operating conditions as indicated in Figs. 15-18.

Technical Specifications (continued)

Heat Transfer via Convection

The thermal data presented here is based on physical measurements taken in a wind tunnel, using automated thermo-couple instrumentation to monitor key component temperatures: FETs, diodes, control ICs, magnetic cores, ceramic capacitors, optoisolators, and module PWB conductors, while controlling the ambient airflow rate and temperature. For a given airflow and ambient temperature, the module output power is increased, until one (or more) of the components reaches its maximum derated operating temperature, as defined in IPC-9592B. This procedure is then repeated for a different airflow or ambient temperature until a family of module output derating curves is obtained. Please refer to the Application Note “Thermal Characterization Process For Open-Frame Board-Mounted Power Modules” for a detailed discussion of thermal aspects including maximum device temperatures.

Layout Considerations

The QBVS128A0B power module series are low profile in order to be used in fine pitch system card architectures. As such, component clearance between the bottom of the power module and the mounting board is limited. Avoid placing copper areas on the outer layer directly underneath the power module. Also avoid placing via interconnects underneath the power module.

For additional layout guide-lines, refer to FLT012A0Z Preliminary Data Sheet.

Through-Hole Lead-Free Soldering Information

The RoHS-compliant, Z version, through-hole products use the SAC (Sn/Ag/Cu) Pb-free solder and RoHS-compliant components. The module is designed to be processed through single or dual wave soldering machines. The pins have a RoHS-compliant, pure tin finish that is compatible with both Pb and Pb-free wave soldering processes. A maximum preheat rate of 3°C/s is suggested. The wave preheat process should be such that the temperature of the power module board is kept below 210°C. For Pb solder, the recommended pot temperature is 260°C, while the Pb-free solder pot is 270°C max.

Reflow Soldering

The RoHS-compliant through-hole products can be processed with the following pin-in-paste (paste-in-hole) Pb or Pb-free reflow process.

Max. sustain temperature:

245°C (J-STD-020C Table 4-2: Packaging Thickness ≥ 2.5mm / Volume > 2000mm³),

Peak temperature over 245°C is not suggested due to the potential reliability risk of components under continuous high-temperature.

Min. sustain duration above 217°C : 90 seconds

Min. sustain duration above 180°C : 150 seconds

Max. heat up rate: 3°C /sec

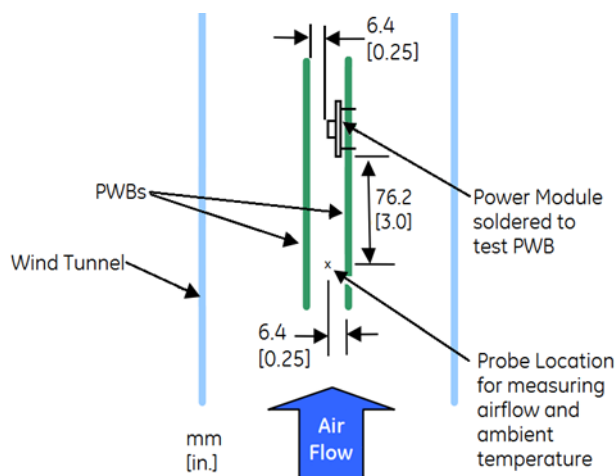

Figure 14. Thermal Test Setup

Increased airflow over the module enhances the heat transfer via convection. The thermal derating of figure 15– 18 shows the maximum output current that can be delivered by each module in the indicated orientation without exceeding the maximum TH1 temperature versus local ambient temperature (TA) for several air flow conditions.

Technical Specifications (continued)

Thermal Considerations

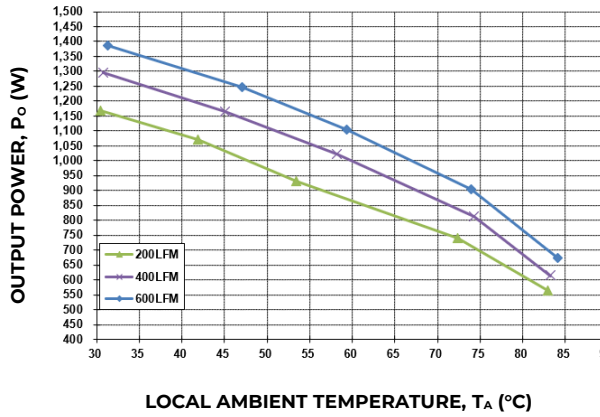

Figure 15. Output Power Derating for the Base Plate QBVS128A0B-H; Airflow Direction for Vout to Vin(Worst) orientation; Vin = 50V.

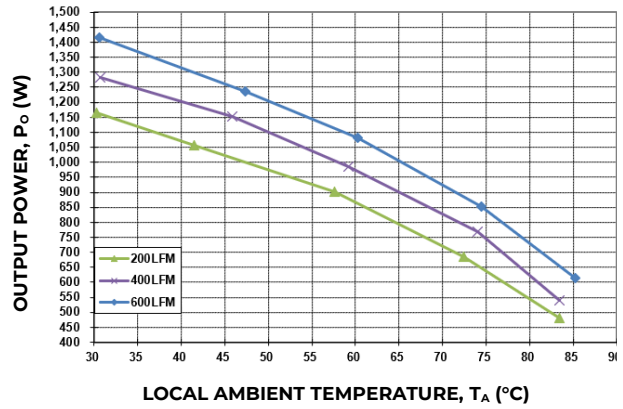

Figure 16. Output Power Derating for the Base Plate QBVS128A0B-H; Airflow Direction for Vout to Vin(Worst) orientation; Vin = 54V.

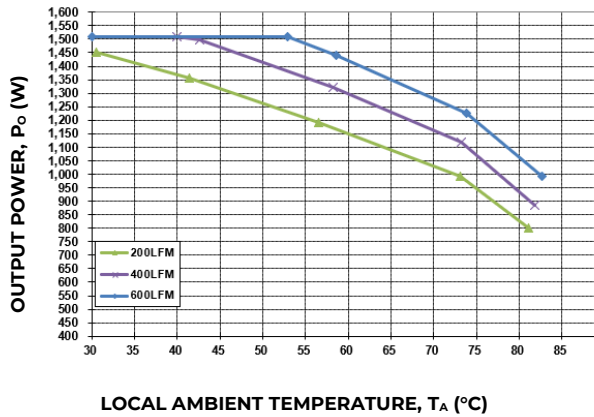

Figure 17. Output Power Derating for the Base plate QBVS128A0B-H+0.44" Heat Sink; Airflow Direction for Vout to Vin(Worst) orientation; Vin = 50V.

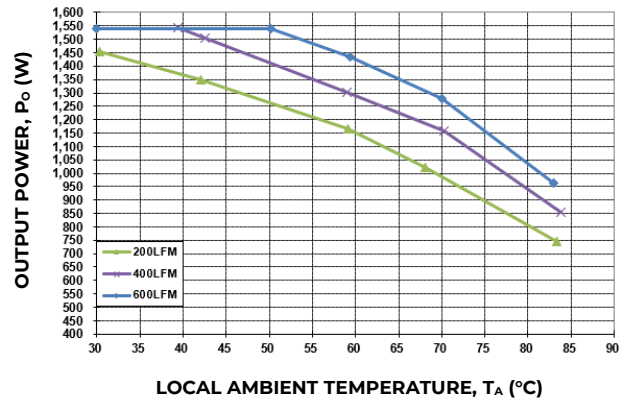

Figure 18. Output Power Derating for the Base plate QBVS128A0B-H+0.44" Heat Sink; Airflow Direction for Vout to Vin(Worst) orientation; Vin = 54V.

Technical Specifications (continued)

Max. cool down rate: 4°C C/sec

In compliance with JEDEC J-STD-020C spec for 2 times reflow requirement.

Pb-free Reflow Profile

BMP module will comply with JEDEC J-STD-020 Rev. D (Moisture/Reflow Sensitivity Classification for

Non-hermetic Solid-State Surface Mount Devices) for both Pb-free solder profiles and MSL classification procedures.

BMP will comply with J-STD-020C specification for reflow up to 3 times. When removing a module, using localized hot air counts as one reflow, but using a solder pot instead to heat the pins does not count as a reflow.

The suggested Pb-free solder paste is Sn/Ag/Cu (SAC). The recommended linear reflow profile using Sn/Ag/Cu solder is shown in Figure 25.

MSL Rating

The QBVS128A10R4 modules have a MSL rating as indicated in the Device Codes table, last page of this document.

Storage and Handling

The recommended storage environment and handling procedures for moisture-sensitive surface mount packages is detailed in J-STD-033 Rev. A (Handling, Packing, Shipping and Use of Moisture/Reflow Sensitive Surface Mount Devices). Moisture barrier bags (MBB) with desiccant are required for MSL ratings of 2 or greater. These sealed packages should not be broken until time of use. Once the original package is broken, the floor life of the product at conditions of $\leq 30^{\circ}\text{C}$ and 60% relative humidity varies according to the MSL rating (see J-STD-060A). The shelf life for dry packed SMT packages will be a minimum of 12 months from the bag seal date, when stored at the following conditions: $< 40^{\circ}\text{C}$, $< 90\%$ relative humidity.

Post Solder Cleaning and Drying Considerations

Post solder cleaning is usually the final circuit board assembly process prior to electrical board testing. The result of inadequate cleaning and drying can affect both the reliability of a power module and the testability of the finished circuit board assembly. For guidance on appropriate soldering, cleaning and drying procedures, refer to GE Board Mounted Power Modules: Soldering and Cleaning Application Note (AN04-001).

If additional information is needed, please consult with your OmniOn Sales representative for more details

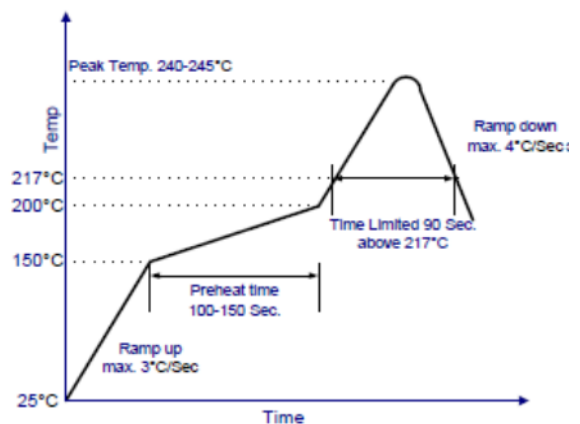

Figure 19. Recommended linear reflow profile using Sn/Ag/Cu solder.

Technical Specifications (continued)

Mechanical Outline for QBVS128A0B(Base plate) Through-hole Module

Dimensions are in millimeters and [inches].

Tolerances: x.x mm ± 0.5 mm [x.xx in. ± 0.02 in.] (Unless otherwise indicated)

x.xx mm ± 0.25 mm [x.xxx in ± 0.010 in.]

TOP VIEW

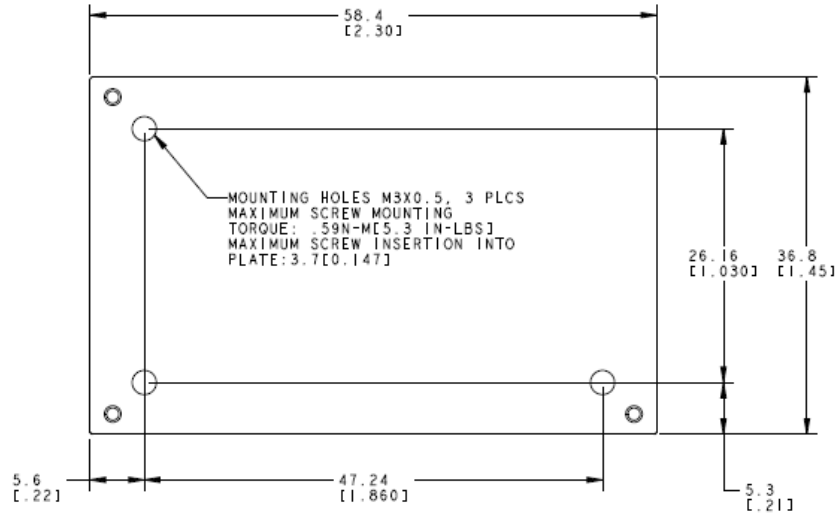

SIDE VIEW

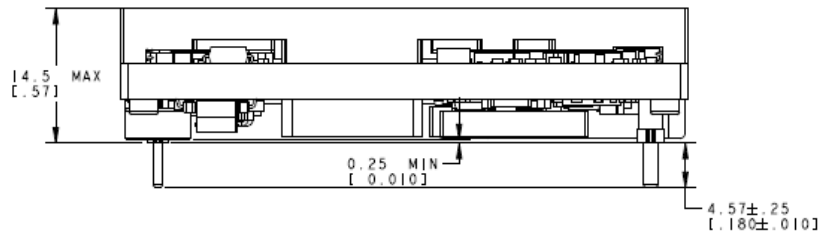

BOTTOM VIEW

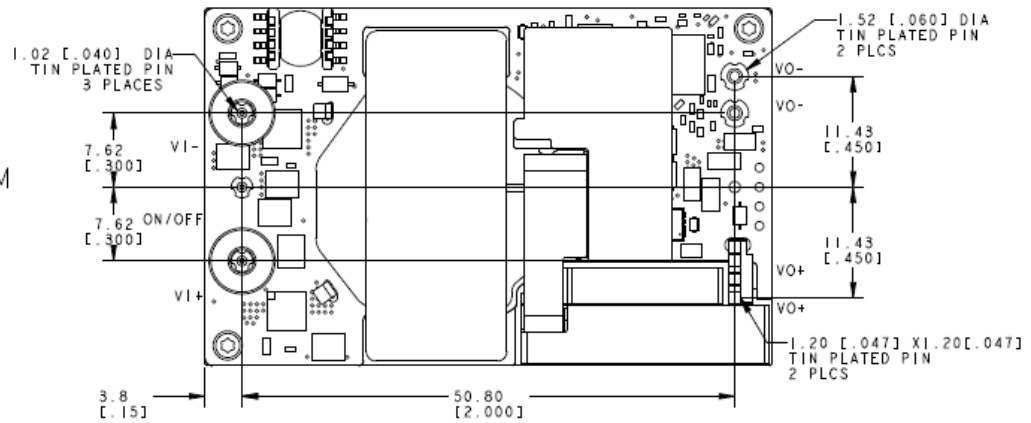

Technical Specifications (continued)

Recommended Pad Layouts

Dimensions are in millimeters and (inches).

Tolerances: x.x mm \pm 0.5 mm [x.xx in. \pm 0.02 in.] (unless otherwise indicated)

x.xx mm \pm 0.25 mm [x.xxx in. \pm 0.010 in.]

Pin Number	Pin Name
1	VIN(+)
2	ON/OFF
3	VIN(-)
4	VOUT(-)
5	VOUT(-)
6	VOUT(+)
7	VOUT(+)

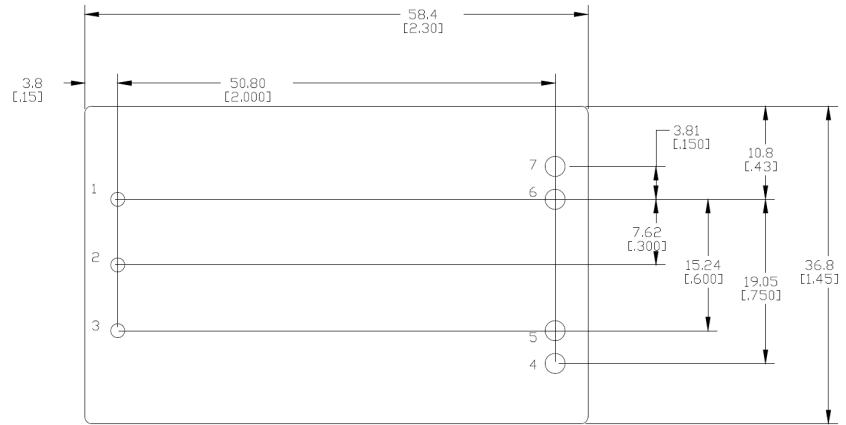

TOP VIEW

Hole and Pad diameter recommendations:

Pin Number	Hole Dia mm [in]	Pad Dia mm [in]
1, 2, 3	1.6 [0.063]	2.1 [0.083]
4,5,6,7	2.3 [0.091]	3.3 [0.130]

Packaging Details

All versions of the QBVS128A0B are supplied as standard in the plastic trays shown in Figure 27.

Tray Specification

Material	PET (1mm)
Max surface resistivity	10^9 - 10^{11} W/PET
Color	Clear
Capacity	12 power modules
Min order quantity	24 pcs (1 box of 2 full trays + 1 empty top tray)



Base Plate Module Tray

Figure 27. QBVS128A0B Packaging Tray

Each tray contains a total of 12 power modules. The trays are self-stacking and each shipping box for the QBVS128A0B module contains 2 full trays plus one empty hold-down tray giving a total number of 24 power modules.

Ordering Information

Table 1. Device Codes.

Product Codes	Input Voltage	Output Voltage	Output Current	Efficiency	Connector Type	MSL Ra-ting	Com Codes
QBVS128A0B41-HZ	54V (48-60Vdc)	12V	128A	97%	Through hole	2a	1600398095A

Table 2. Device Options.

Characteristic	Character and Position										Definition	
Form Factor	Q											Q = Quarter Brick
Family Designator		BV										BV = BARRACUDA Analog Series
Input Voltage			S									S = Special input voltage 45V - 56V
Output Power				128A0								128A = 128A Rated Output Current
Output Voltage					B							B = 12V nominal
Pin Length												Omit = Default Pin Length shown in Mechanical Outline (4.57 mm)
						8						8 = Pin Length: 2.79 mm ± 0.25mm, (0.110 in. ± 0.010 in.)
						6						6 = Pin Length: 3.68 mm ± 0.25mm, (0.145 in. ± 0.010 in.)
Action following												Omit = Latching Mode
Protective Shutdown						4						4 = Auto-restart following shutdown (Overcurrent/Overvoltage)
On/off Logic												Omit = Positive Logic
						1						1 = Negative Logic
Heat Plate										H		H = Heat plate, for use with a heat sink or cold wall
RoHS											Z	Z = RoHS Compliant

Change History (excludes grammar & clarifications)

Revision	Date	Description of the change
1.2	06/14/2022	Updated ROHS
1.3	12/01/2023	Updated as per OmniOn template
1.4	01/05/2024	Pg 4 changed unit from ms to μ s

OmniOn Power Inc.

601 Shiloh Rd.
Plano, TX USA

omnionpower.com

We reserve the right to make technical changes or modify the contents of this document without prior notice. OmniOn Power does not accept any responsibility for errors or lack of information in this document and makes no warranty with respect to and assumes no liability as a result of any use of information in this document.

We reserve all rights in this document and in the subject matter and illustrations contained therein. Any reproduction, disclosure to third parties or utilization of its contents – in whole or in parts – is forbidden without prior written consent of OmniOn Power. This document does not convey license to any patent or any intellectual property right. Copyright© 2023 OmniOn Power Inc. All rights reserved.