

QBVS046A9S9R6 Barracuda* Series; DC-DC Converter Power Modules

45-55Vdc Input; 9.6Vdc, 46.9A, 450W Output

RoHS Compliant

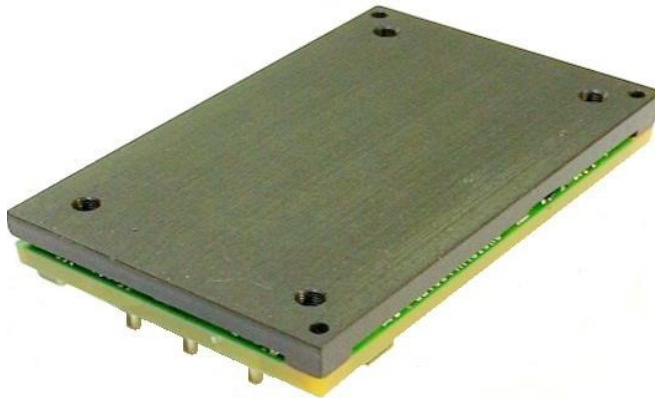

Description

The QBVS046A9S9R6 Barracuda series of dc-dc converters are a new generation of fully regulated DC/DC power modules designed to support 9.6Vdc intermediate bus applications where multiple low voltages are subsequently generated using point of load (POL) converters, as well as other application requiring a tightly regulated output voltage. The QBVS046A9S9R6 series operate from an input voltage range of 45 to 55Vdc and provide up to 46.9A output current at output

voltages of 9.6Vdc in an industry standard, DOSA compliant quarter brick. The converter incorporates digital control, synchronous rectification technology, a fully regulated control topology, and innovative packaging techniques to achieve efficiency exceeding 96% at 9.6V output. This leads to lower power dissipations such that for many applications a heat sink is not required. Standard features include on/off control, output overcurrent and over voltage protection, over temperature protection, input under and over voltage lockout.

The output is fully isolated from the input, allowing versatile polarity configurations and grounding connections. Built-in filtering for both input and output minimizes the need for external filtering.

Applications

- Distributed power architectures
- Intermediate bus voltage applications
- Servers and storage applications
- Fan assemblies and other systems requiring a tightly regulated output voltage.

Features

- Compliant to RoHS Directive 2011/65/EU and amended Directive (EU) 2015/863.
- Compliant to REACH Directive (EC) No 1907/2006
- Can be processed with paste-through-hole Pb or Pb-free reflow process
- High full load efficiency >96% at $V_{in}=48V_{dc}$
- Input voltage range: 45-55Vdc
- Delivers up to 46.9A_{dc} output current
- Fully very tightly regulated output voltage
- Low output ripple and noise
- Industry standard, DOSA Compliant Quarter Brick:
58.4 mm x 36.8 mm x 12.2 mm MAX
(2.30 in x 1.45 in x 0.48 in, MAX)
- Constant switching frequency
- Positive Remote On/Off logic
- Output over current/voltage protection
- Over temperature protection
- Wide operating temperature range
-5°C to 55°C, continuous, 100% load, $\geq 1.0m/s$ [200LFM]
-20°C to 70°C, short term, $\leq 96hrs/year$, 100% load
-5°C to 85°C, continuous, derated load
- ANSI/UL* 62368-1 and CAN/CSA† C22.2 No. 62368-1 Recognized, DIN VDE‡ 0868-1/A11:2017 (EN62368-1:2014/A11:2017)
- CE mark to 2014/35/EU directive§
- 750Vdc Functional Isolation
- ISO** 9001 and ISO14001 certified manufacturing facilities
- Negative Remote On/Off logic (1=option code, factory preferred)
- Passive Droop Load Sharing (-P=option code)
- Base Plate (-H=option code)
- Auto-restart after fault shutdown (4=option code, factory preferred)

* Trademark of OmniOn Company

UL is a registered trademark of Underwriters Laboratories, Inc.

† CSA is a registered trademark of Canadian Standards Association.

‡ VDE is a trademark of Verband Deutscher Elektrotechniker e.V.

§ This product is intended for integration into end-user equipment. All of the required procedures of end-use equipment should be followed.

** ISO is a registered trademark of the International Organization of Standards.

Technical Specifications

Absolute Maximum Ratings

Stresses in excess of the absolute maximum ratings can cause permanent damage to the device. These are absolute stress ratings only, functional operation of the device is not implied at these or any other conditions in excess of those given in the operations sections of the Data Sheet. Exposure to absolute maximum ratings for extended periods can adversely affect device reliability.

Parameter	Device	Symbol	Min	Max	Unit
Input Voltage*					
Continuous		V_{IN}	-0.3	55	V_{dc}
Non-operating continuous		V_{IN}		64	V_{dc}
Continuous Operating Ambient Temperature, 100% Load, Airflow $\geq 1.0\text{m/s}$ [200LFM], $V_{IN} = 45$ to 55V	All	T_A	-5	55	$^{\circ}\text{C}$
Short term Operating Ambient Temperature, 100% Load, $\leq 96\text{hrs/year}$; Airflow $\geq 1.0\text{m/s}$ [200LFM], $V_{IN} = 45$ to 55V		T_A	-20	70	$^{\circ}\text{C}$
Continuous Derated Operating Ambient Temperature		T_A	—	85	$^{\circ}\text{C}$
Storage Temperature	All	T_{stg}	-40	125	$^{\circ}\text{C}$
I/O Isolation Voltage (100% factory Hi-Pot tested)	All		—	750	V_{dc}

* Input over voltage protection will shutdown the output voltage when the input voltage exceeds threshold level.

Electrical Specifications

Unless otherwise indicated, specifications apply over all operating input voltage, resistive load, and temperature conditions.

Parameter	Device	Symbol	Min	Typ	Max	Unit
Operating Input Voltage		V_{IN}	45	50/54	55	V_{dc}
Maximum Input Current ($V_{IN}=45\text{V}$, $I_O=I_{O, max}$)		$I_{IN,max}$	—	—	11	A_{dc}
Input No Load Current ($V_{IN} = V_{IN, nom}$, $I_O = 0$, module enabled)	All	$I_{IN,No IOAD}$		130		mA
Input Stand-by Current ($V_{IN} = V_{IN, nom}$, module disabled)	All	$I_{IN,stand-by}$			35	mA
External Input Capacitance	All		100	—	450	μF
Inrush Transient	All	I^2t	—	—	1	A^2s
Input Reflected Ripple Current, peak-to-peak (5Hz to 20MHz, 12 μH source impedance; $V_{IN}= 48\text{V}$, $I_O= I_{Omax}$; see Figure 9)	All		—	35	—	mA _{p-p}
Input Terminal Ripple Current (Measured at module input pin with maximum specified input capacitance and < 500uH inductance between voltage source and input capacitance) 5Hz to 20MHz, $V_{IN}= 45\text{V}$ to 55V , $I_O= I_{Omax}$	All		—	—	450	mArms
Input Ripple Rejection (120Hz)	All		—	20	—	dB
Output Voltage Set-point ($V_{IN}=V_{IN, nom}$, $I_O=23.5\text{A}$, $T_A =25^{\circ}\text{C}$)	All	V_O, set	9.55	9.60	9.65	V_{dc}

Technical Specifications (continued)

Electrical Specifications (continued)

Parameter	Device	Symbol	Min	Typ	Max	Unit
Output Voltage (Over all operating input voltage (45V to 55V), resistive load, and temperature conditions until end of life)	-P Option	V_o	8.90	—	10.30	V_{dc}
Output Regulation Line ($V_{IN}=V_{IN, min}$ to $V_{IN, max}$)	All		—	0.3	$\frac{3}{4}$	% $V_{O, set}$
Load ($I_o=I_{o, min}$ to $I_{o, max}$), Intentional Droop	-P Option			0.20		V_{dc}
Temperature ($T_A = -5^{\circ}C$ to $+85^{\circ}C$)	All		—	—	0.02	%/ $^{\circ}C$
Output Ripple and Noise on nominal output ($V_{IN}=V_{IN, nom}$ and $I_o=I_{o, min}$ to $I_{o, max}$) $C_O=750\mu F$						
RMS (5Hz to 20MHz bandwidth)	All		—	70	$\frac{3}{4}$	mVpk-pk
Peak-to-Peak (5Hz to 20MHz bandwidth)	All		—	—	150	mVpk-pk
External Output Capacitance For $C_O > 5,625\mu F$, I_O must be $< 35\%$ $I_{o, max}$ during T_{rise} .	All	$C_{O, max}$	0	—	5,625	μF
When 2 or more modules are in parallel	-P Option		0		11,250	μF
Output Current	All	I_o	0	—	46.9	A_{dc}
Output Current Limit Inception	All	$I_{o, lim}$	51.6	—	65.7	A_{dc}
Output Power	All	P_o	0	—	450	W
Efficiency $V_{IN}=V_{IN, nom}$, $T_A=25^{\circ}C$ $I_o=100\%$ $I_{o, max}$, $V_o=V_{o, set}$ $I_o=50\%$ $I_{o, max}$ to 100% $I_{o, max}$, $V_o=V_{o, set}$	All	η		96.0		%
	All	η		95.0		%
Switching Frequency (Primary FETs)		f_{sw}		150		kHz
Dynamic Load Response $dI_o/dt=1A/1\mu s$; $V_{in}=V_{in, nom}$; $T_A=25^{\circ}C$; (Tested with a $1.0\mu F$ ceramic, and $1800\mu F$ capacitor and across the load.)						
Load Change from $I_o = 50\%$ to 75% of $I_{o, max}$						
Peak Deviation	All	V_{pk}	—	350	—	mVpk
Settling Time ($VO < 10\%$ peak deviation)		t_s	—	700	—	mS
Load Change from $I_o = 75\%$ to 50% of $I_{o, max}$						
Peak Deviation	All	V_{pk}	—	350	—	mVpk
Settling Time ($VO < 10\%$ peak deviation)		t_s	—	700	—	mS

CAUTION: This power module is not internally fused. An input line fuse must always be used.

This power module can be used in a wide variety of applications, ranging from simple standalone operation to an integrated part of sophisticated power architecture. To preserve maximum flexibility, internal fusing is not included, however, to achieve maximum safety and system protection, always use an input line fuse. The safety agencies require a fast-acting fuse with a maximum rating of 20A in the ungrounded input lead of the power supply (see Safety Considerations section). Based on the information provided in this Data Sheet on inrush energy and maximum dc input current, the same type of fuse with a lower rating can be used. Refer to the fuse manufacturer's Data Sheet for further information.

Technical Specifications (continued)

Isolation Specifications

Parameter	Symbol	Min	Typ	Max	Unit
Isolation Capacitance	C_{iso}	—	0.01	—	mF
Isolation Resistance	R_{iso}	10	—	—	M Ω

General Specifications

Parameter	Device	Symbol	Typ	Unit
Calculated Reliability Based upon 480W parent product [QBVS044A4S10R8] and Telcordia SR-332 Issue 2: Method I, Case 3, ($I_O=80\%I_{O, max}$, $T_A=40^\circ\text{C}$, Airflow = 200 LFM), 90% confidence	All	MTBF	3,570,960	Hours
	All	FIT	280.0	10 ⁹ /Hours
Weight – with Base Plate option			69.8 (2.46)	g (oz.)

Feature Specifications

Unless otherwise indicated, specifications apply over all operating input voltage, resistive load and temperature conditions. See feature descriptions for additional information.

Parameter	Device	Symbol	Min	Typ	Max	Unit
Remote On/Off Signal Interface ($V_{IN}=V_{IN, min}$ to $V_{IN, max}$, Signal referenced to VIN- terminal) Negative Logic: device code suffix "1" Logic Low = module On, Logic High = module Off Positive Logic: No device code suffix required Logic Low = module Off, Logic High = module On Logic Low Specification On/Off Thresholds:						
Remote On/Off Current – Logic Low ($V_{in} = 55\text{V}$)	All	$I_{on/off}$	—	—	200	μA
Logic Low Voltage	All	$V_{on/off}$	0.3	—	0.8	V_{dc}
Logic High Voltage – (Typ = Open Collector)	All	$V_{on/off}$	2.4	—	14.5	V_{dc}
Logic High maximum allowable leakage current ($V_{on/off} = 2.4\text{V}$)	All	$I_{on/off}$	—	—	130	μA
Maximum voltage allowed on On/Off pin	All	$V_{on/off}$	—	—	14.5	V_{dc}
Turn-On Delay and Rise Times ($I_O=I_O, max$) T_{delay} =Time until $V_O = 10\%$ of $V_{O,set}$ from either application of V_{in} with Remote On/Off set to On (Enable with V_{in}); or operation of Remote On/Off from Off to On with V_{in} already applied for at least 30 milliseconds (Enable with on/off). *If pre-bias is detected, T_{delay} will increase by an additional 5ms.	All w/ "P" option All w/ "P" option	$T_{delay, Enable}$ with V_{in} $T_{delay, Enable}$ with V_{in}	—	—	15* 10*	ms
T_{rise} =Time for V_O to rise from 10% to 90% of $V_{O,set}$, For $CO>5,625\mu\text{F}$, I_O must be $< 35\% I_{O, max}$ during T_{rise} .	All w/ "P" option	T_{rise}	—	—	15	ms
Output Overvoltage Protection	All	$V_{O,limit}$	12.0		14.0	V_{dc}

Technical Specifications (continued)

Features Specifications (continued)

Unless otherwise indicated, specifications apply over all operating input voltage, resistive load, and temperature conditions. See Feature Descriptions for additional information.

Parameter	Device	Symbol	Min	Typ	Max	Unit
Maximum Long Term Reference Temperature (See Feature Descriptions and Figure 13)	All	T_{ref}	—	110	—	$^{\circ}\text{C}$
Input Undervoltage Lockout						
Turn-on Threshold			43	—	45	V_{dc}
Turn-off Threshold			40	—	43	V_{dc}
Hysteresis			2	—	—	V_{dc}
Input Overvoltage Lockout						
Turn-off Threshold			—	62	—	V_{dc}
Turn-on Threshold			—	60	—	V_{dc}

Characteristic Curves, 9.6Vdc Output

The following figures provide typical characteristics for the QBVS046A9S9R6 (9.6V, 46.9A) at 25°C. The figures are identical for either positive or negative Remote On/Off logic.

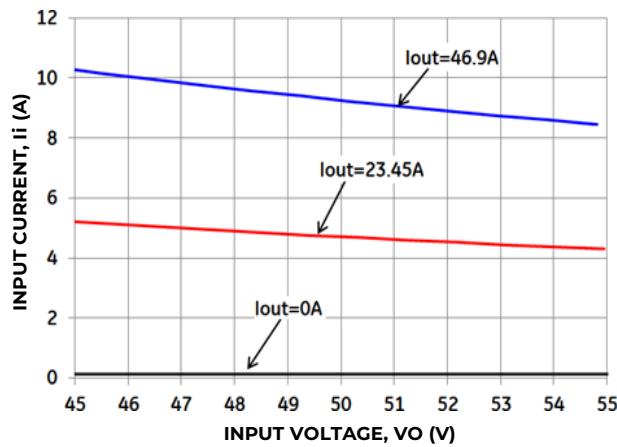

Figure 1. Typical Input Characteristic

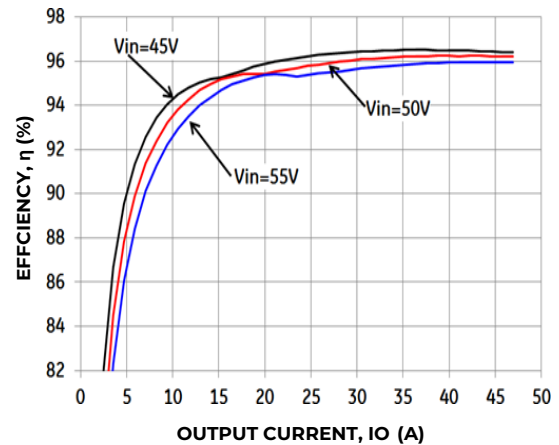

Figure 2. Typical Converter Efficiency vs. Output Current

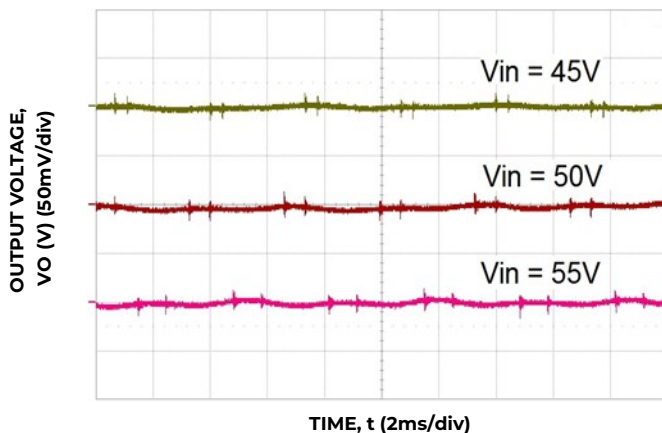

Figure 3. Typical Output Ripple and Noise, $I_o = I_{o,max}$, $C_O=750\mu F$

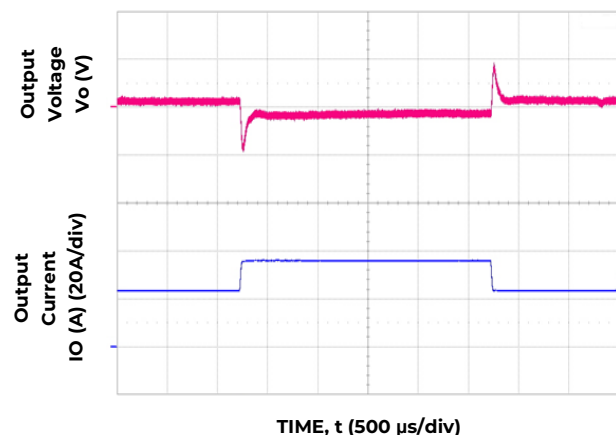

Figure 4. Typical Transient Response to 1A/ μs Step Change in Load from 50% to 75% to 50% of Full Load, $C_O=1800\mu F$ and 50 Vdc Input

Technical Specifications (continued)

Characteristic Curves, 9.6Vdc Output (continued)

The following figures provide typical characteristics for the QBVS046A9S9R6 (9.6V, 46.9A) at 25°C. The figures are identical for either positive or negative Remote On/Off logic.

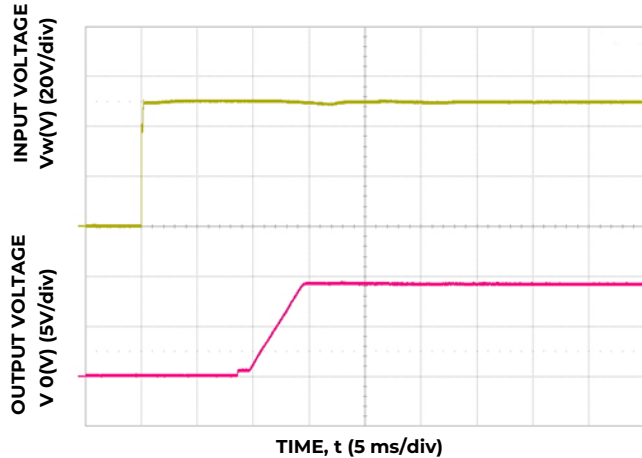

Figure 5. Typical Start-Up Using V_{in} with Remote On/Off enabled, negative logic version shown, $I_o = I_o, \max$

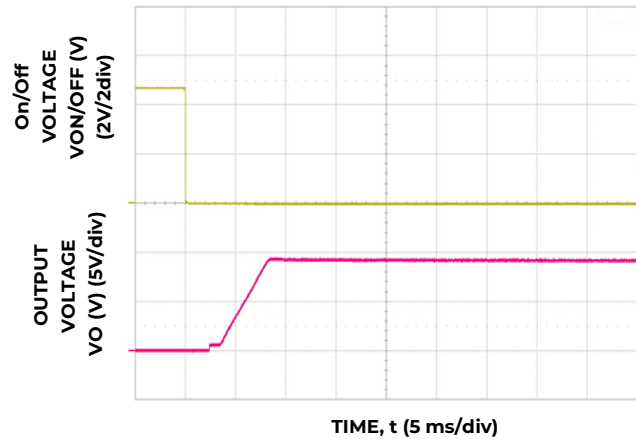

Figure 6. Typical Start-Up Using Remote On/Off with V_{in} applied, negative logic version shown $I_o = I_o, \max$

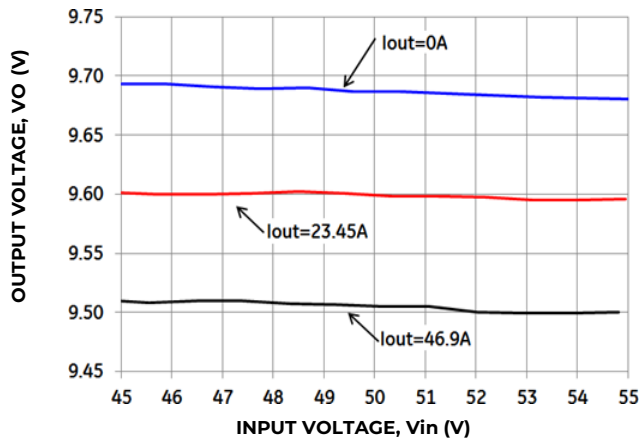

Figure 7. Typical Output Voltage Regulation vs. Input Voltage the -P Version

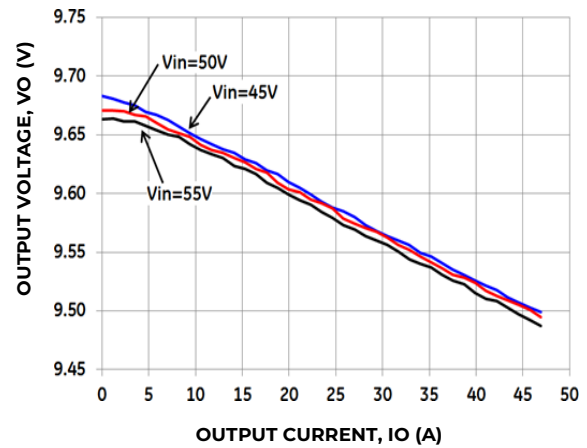

Figure 8. Typical Output Voltage Regulation vs. Output Current for the -P Version

Technical Specifications (continued)

Test Configurations

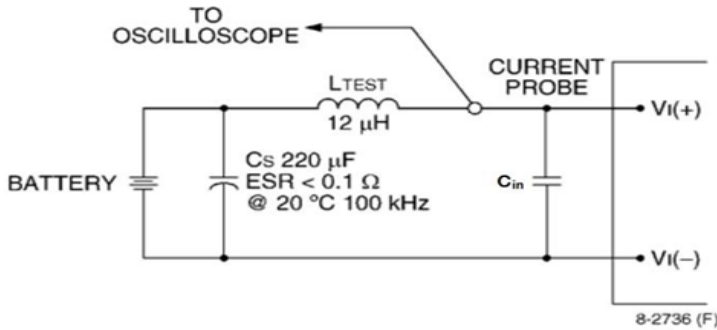

Figure 9. Input Reflected Ripple Current Test Setup

Note: Measure input reflected-ripple current with a simulated source inductance (LTEST) of 12 μH. Capacitor CS offsets possible battery impedance. Measure current as show above.

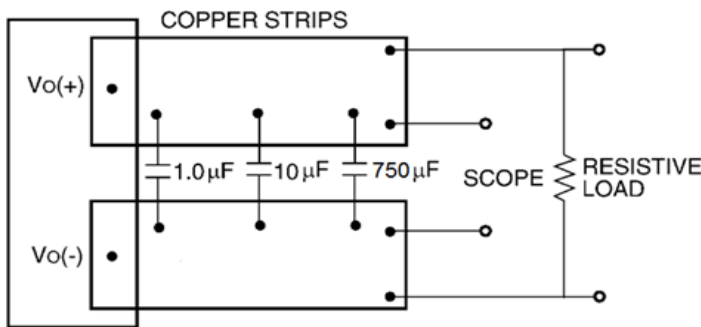

Figure 10. Output Ripple and Noise Test Setup

Note: Use a 1.0 μF ceramic capacitor, a 10 μF aluminum or tantalum capacitor and a 750 polymer capacitor. Scope measurement should be made using a BNC socket. Position the load between 51 mm and 76 mm (2 in. and 3 in.) from the module.

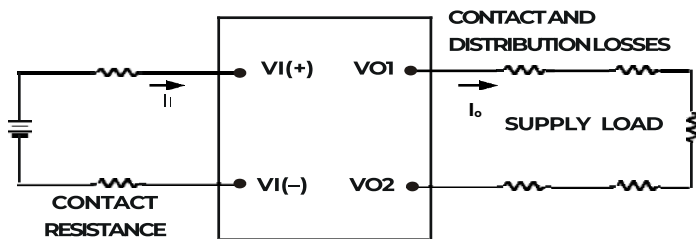

Figure 11. Output Voltage and Efficiency Test Setup

Note: All measurements are taken at the module terminals. When socketing, place Kelvin connections at module terminals to avoid measurement errors due to socket contact resistance.

$$\eta = \left(\frac{[V_{O(+)} - V_{O(-)}]I_o}{[V_{I(+)} - V_{I(-)}]I_i} \right) \times 100 \%$$

Design Considerations

Input Source Impedance

The power module should be connected to a low ac-impedance source. Highly inductive source impedance can affect the stability of the power module. For the test configuration in Figure 9, a 450μF electrolytic capacitor, Cin, (ESR<0.7W at 100kHz), mounted close to the power module helps ensure the stability of the unit.

Safety Considerations

For safety agency approval the power module must be installed in compliance with the spacing and separation requirements of the end-use safety agency standards, i.e., ULANSI/UL 62368-1 and CAN/CSAC22.2 No. 62368-1 Recognized, DIN VDE 0868-1/A11:2017 (EN62368- 1:2014/ A11:2017)

If the input source is non-SELV/ES1 (ELV or a hazardous voltage greater than 60 Vdc and less than or equal to 75Vdc), for the module's output to be considered as meeting the requirements for safety extra-low voltage (SELV) or ES1, all of the following must be true:

- The input source is to be provided with reinforced insulation from any other hazardous voltages, including the ac mains.
- One VIN pin and one VOUT pin are to be grounded, or both the input and output pins are to be kept floating.
- The input pins of the module are not operator accessible.
- Another SELV or ES1 reliability test is conducted on the whole system (combination of supply source and subject module), as required by the safety agencies, to verify that under a single fault, hazardous voltages do not appear at the module's output

Technical Specifications (continued)

Note: Do not ground either of the input pins of the module without grounding one of the output pins. This may allow a non-SELV/ES1 voltage to appear between the output pins and ground.

The power module has safety extra-low voltage (SELV) or ES1 outputs when all inputs are SELV or ES1.

The input to these units is to be provided with a maximum 20A fast-acting (or time-delay) fuse in the ungrounded input lead.

Feature Descriptions

Overcurrent Protection

To provide protection in a fault output overload condition, the module is equipped with internal current-limiting circuitry and can endure current limiting continuously. If the overcurrent condition causes the output voltage to fall greater than 3.5V from $V_{o,set}$, the module will shut down and remain latched off. The overcurrent latch is reset by either cycling the input power or by toggling the on/off pin for one second. If the output overload condition still exists when the module restarts, it will shut down again. This operation will continue indefinitely until the overcurrent condition is corrected.

A factory configured auto-restart option (with overcurrent and overvoltage auto-restart managed as a group) is also available. An auto-restart feature continually attempts to restore the operation until fault condition is cleared.

Remote On/Off

The module contains a standard on/off control circuit reference to the $V_{IN}(-)$ terminal. Two factory configured remote on/off logic options are available. Positive logic remote on/off turns the module on during a logic-high voltage on the ON/OFF pin, and off during a logic low. Negative logic remote on/off turns the module off during a logic high, and on during a logic low. Negative logic, device code suffix "1," is the factory-preferred configuration. The On/Off circuit is powered from an internal bias supply, derived from the input voltage terminals. To turn the power module on and off, the user must supply a switch to control the voltage between the On/Off terminal and the $V_{IN}(-)$ terminal ($V_{on/off}$). The switch can be an open collector or equivalent (see Figure 12). A logic low is $V_{on/off} = -0.3V$ to $0.8V$. The typical $I_{on/off}$ during a logic low ($V_{in}=48V$, On/Off Terminal= $0.3V$) is $147\mu A$. The switch should

maintain a logic-low voltage while sinking $200\mu A$. During a logic high, the maximum $V_{on/off}$ generated by the power module is 14.5V. The maximum allowable leakage current of the switch at $V_{on/off} = 2.4V$ is $130\mu A$. If using an external voltage source, the maximum voltage $V_{on/off}$ on the pin is 14.5V with respect to the $V_{IN}(-)$ terminal.

If not using the remote on/off feature, perform one of the following to turn the unit on:

For negative logic, short ON/OFF pin to $V_{IN}(-)$. For positive logic: leave ON/OFF pin open.

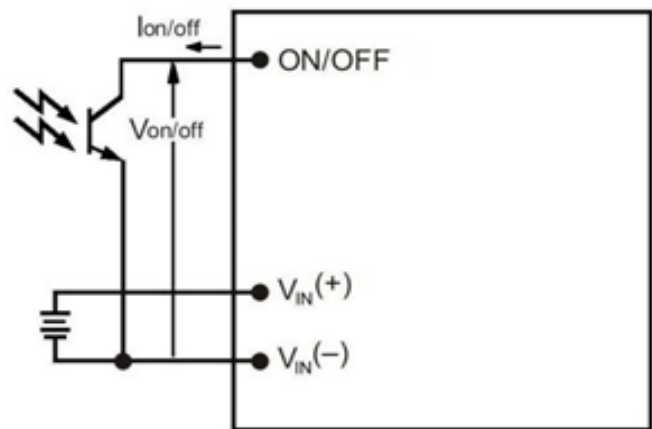

Figure 12. Remote On/Off Implementation

Output Overvoltage Protection

The module contains circuitry to detect and respond to output overvoltage conditions. If the overvoltage condition causes the output voltage to rise above the limit in the Specifications Table, the module will shut down and remain latched off. The overvoltage latch is reset by either cycling the input power, or by toggling the on/off pin for one second. If the output overvoltage condition still exists when the module restarts, it will shut down again. This operation will continue indefinitely until the overvoltage condition is corrected.

A factory configured auto-restart option (with overcurrent and overvoltage auto-restart managed as a group) is also available. An auto-restart feature continually attempts to restore the operation until fault condition is cleared.

Overtemperature Protection

These modules feature an overtemperature protection circuit to safeguard against thermal damage. The circuit shuts down the module when the maximum device

Technical Specifications (continued)

reference temperature is exceeded. The module will automatically restart once the reference temperature cools by $\sim 25^{\circ}\text{C}$.

Input Under/Over voltage Lockout

At input voltages above or below the input under/over voltage lockout limits, module operation is disabled. The module will begin to operate when the input voltage level changes to within the under and overvoltage lockout limits.

Load Sharing

For higher power requirements, the QBVS046A9S9R6 power module offers an optional feature for parallel operation (-P Option code). This feature provides a precise forced output voltage load regulation droop characteristic. The output set point and droop slope are factory calibrated to insure Optimum matching of multiple modules' load regulation characteristics. To implement load sharing, the following requirements should be followed:

- The VOUT(+) and VOUT(-) pins of all parallel modules must be connected together. Balance the trace resistance for each module's path to the output power planes, to insure best load sharing and operating temperature balance.
- VIN must remain between 45Vdc and 55Vdc for droop sharing to be functional.
- It is permissible to use a common Remote On/Off signal to start all modules in parallel.
- These modules contain means to block reverse current flow upon start-up, when output voltage is present from other parallel modules, thus eliminating the requirement for external output ORing devices. Modules with the -P option may automatically increase the Turn On delay, Tdelay, as specified in the Feature Specifications Table, if output voltage is present on the output bus at startup.
- When parallel modules startup into a pre-biased output, e.g. partially discharged output capacitance, the Trise is automatically increased, as specified in the Feature Specifications Table, to insure graceful startup.
- Insure that the total load is $< 50\% I_{O,MAX}$ (for a single module) until all parallel modules have started (load full start $>$ module Tdelay time max + Trise time).
- If fault tolerance is desired in parallel applications,

output ORing devices should be used to prevent a single module failure from collapsing the load bus.

Thermal Considerations

The power modules operate in a variety of thermal environments and sufficient cooling should be provided to help ensure reliable operation.

Thermal considerations include ambient temperature, airflow, module power dissipation, and the need for increased reliability. A reduction in the operating temperature of the module will result in an increase in reliability. The thermal data presented here is based on physical measurements taken in a wind tunnel.

Heat-dissipating components are mounted on the top side of the module. Heat is removed by conduction, convection and radiation to the surrounding environment. Proper cooling can be verified by measuring the thermal reference temperature (Tref).

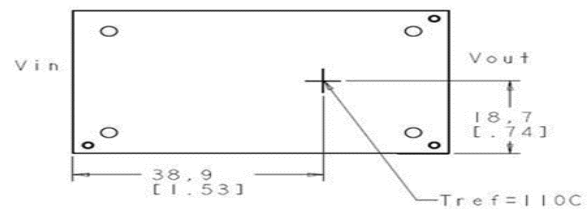

Figure 13. Location of the thermal reference temperature Tref

Peak temperature occurs at the position indicated in Figure 13. For reliable operation this temperature should not exceed $T_{ref} = 110^{\circ}\text{C}$. For extremely high reliability you can limit this temperature to a lower value. The output power of the module should not exceed the rated power for the module as listed in the Ordering Information table.

Technical Specifications (continued)

Heat Transfer via Convection

The thermal data presented here is based on physical measurements taken in a wind tunnel, using automated thermo-couple instrumentation to monitor key component temperatures: FETs, diodes, control ICs, magnetic cores, ceramic capacitors, opto-isolators, and module pwb conductors, while controlling the ambient airflow rate and temperature. For a given airflow and ambient temperature, the module output power is increased, until one (or more) of the components reaches its maximum derated operating temperature, as defined in IPC-9592B. This procedure is then repeated for a different airflow or ambient temperature until a family of module output derating curves is obtained. Please refer to the Application Note “Thermal Characterization Process For Open-Frame Board-Mounted Power Modules” for a detailed discussion of thermal aspects including maximum device temperatures.

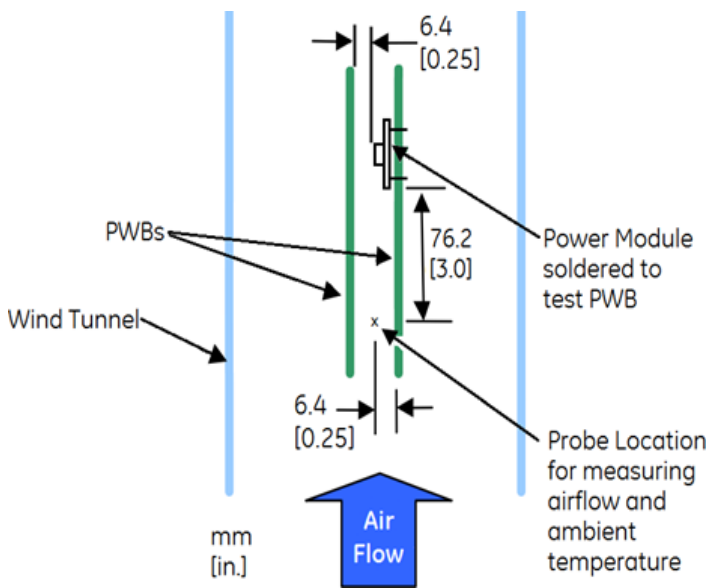

Figure 14. Thermal Test Setup

Increased airflow over the module enhances the heat transfer via convection. The thermal derating of figure 15 - 20 shows the maximum output current that can be delivered by each module in the indicated orientation without exceeding the maximum Tref temperature versus local ambient temperature (TA) for several air flow conditions.

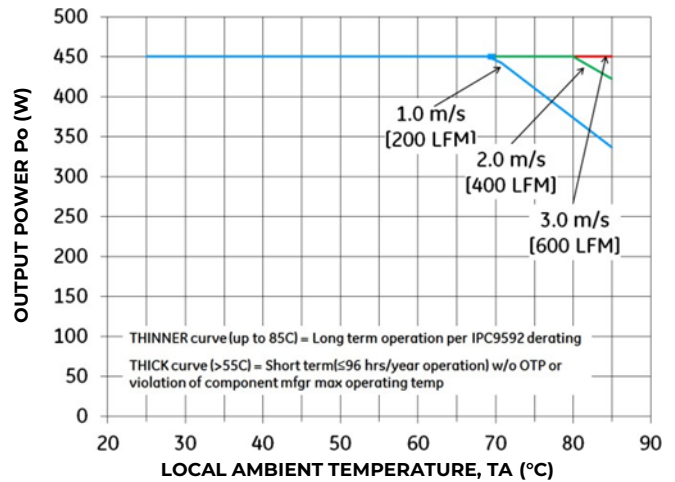

Figure 15. Output Power Derating for the QBVS046A9 S9R6-H Base Plate Option in the Transverse Orientation; Airflow Direction from Vin(-) to Vin(+); Vin = 45V

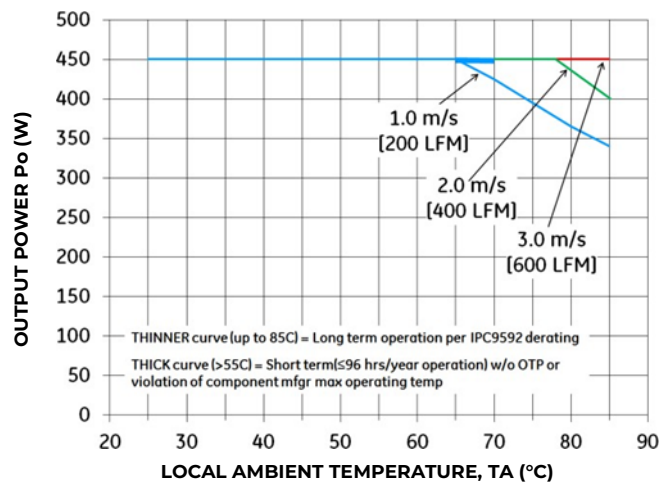

Figure 16. Output Power Derating for the QBVS046A9 S9R6-H Base Plate Option in the Transverse Orientation; Airflow Direction from Vin(-) to Vin(+); Vin = 50V

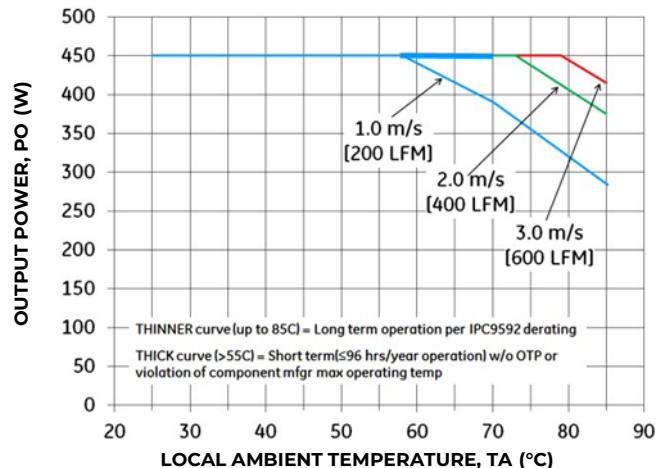

Figure 17. Output Power Derating for the QBVS046A9 S9R6-H Base Plate Option in the Transverse Orientation; Airflow Direction from Vin(-) to Vin(+); Vin = 54-55V

Technical Specifications (continued)

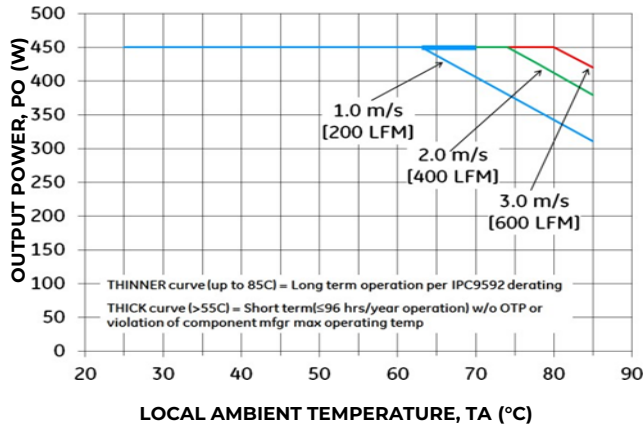

Figure 18. Output Power Derating for the QBVS046A9 S9R6-H Base Plate Option in the Longitudinal Orientation; Airflow Direction from Vout to Vin; = 45V

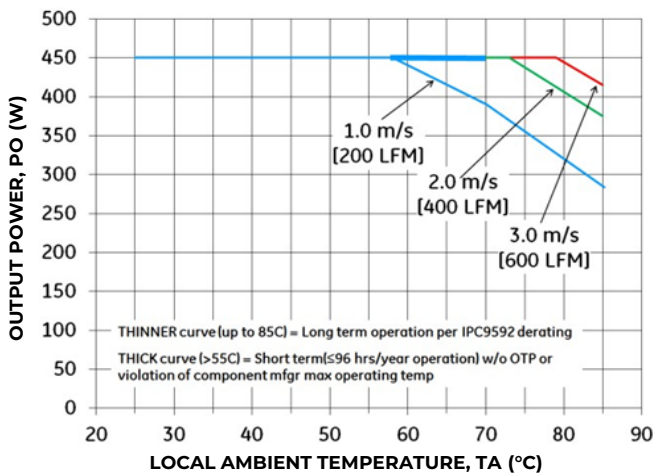

Figure 19. Output Power Derating for the QBVS046A9 S9R6-H Base Plate Option in the Longitudinal Orientation; Airflow Direction from Vout to Vin; = 50V

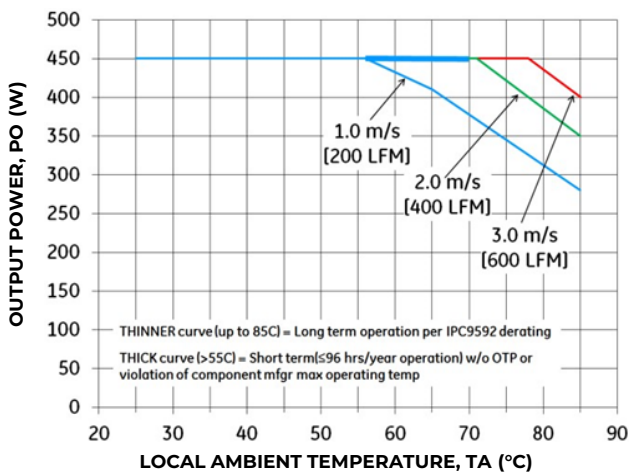

Figure 20. Output Power Derating for the QBVS046A9 S9R6-H Base Plate Option in the Longitudinal Orientation; Airflow Direction from Vout to Vin; = 55-55V

Layout Considerations

The QBVS046A9S9R6 power module series are low profile in order to be used in fine pitch system card architectures. As such, component clearance between the bottom of the power module and the mounting board is limited. Avoid placing copper areas on the outer layer directly underneath the power module. Also avoid placing via interconnects underneath the power module.

For additional layout guide-lines, refer to FLT012A0Z DataSheet.

Through-Hole Lead-Free Soldering Information

The RoHS-compliant, Z version, through-hole products use the SAC (Sn/Ag/Cu) Pb-free solder and RoHS-compliant components. The module is designed to be processed through single or dual wave soldering machines. The pins have a RoHS-compliant, pure tin finish that is compatible with both Pb and Pb-free wave soldering processes. A maximum preheat rate of 3°C/s is suggested. The wave preheat process should be such that the temperature of the power module board is kept below 210°C. For Pb solder, the recommended pot temperature is 260°C, while the Pb-free solder pot is 270°C max.

Reflow Lead-Free Soldering Information

The RoHS-compliant through-hole products can be processed with the following paste-through-hole Pb or Pb-free reflow process.

Max. sustain temperature :

251°C (J-STD-020C Table 4-2: Packaging Thickness >= 2.5mm / Volume > 2000mm³),

Peak temperature over 251°C is not suggested due to the potential reliability risk of components under continuous high-temperature.

Min. sustain duration above 217°: 90seconds

Min. sustain duration above 180°C : 150 seconds
Max. heat up rate: 3°C/sec

Max. cool down rate: 4°C/sec

In compliance with JEDEC J-STD-020C spec for 2 times ref low requirement.

Technical Specifications (continued)

Pb-free Reflow Profile

BMP module will comply with J-STD-020 Rev. C (Moisture/Reflow Sensitivity Classification for Non hermetic Solid State Surface Mount Devices) for both Pb-free solder profiles and MSL classification procedures. BMP will comply with JEDEC J-STD-020C specification for 3 times reflow requirement.

The suggested Pb-free solder paste is Sn/Ag/Cu (SAC). The recommended linear reflow profile using Sn/Ag/Cu solder is shown in Figure 21.

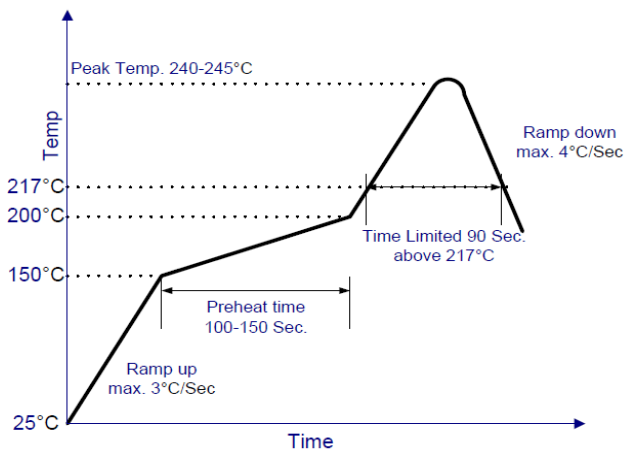

Figure 21. Recommended linear reflow profile using Sn/Ag/Cu solder

MSL Rating

The QBVS046A9S9R6 modules have a MSL rating as indicated in the Device Codes table, last page of this document.

Storage and Handling

The recommended storage environment and handling procedures for moisture-sensitive surface mount packages is detailed in J-STD-033 Rev. A (Handling, Packing, Shipping and Use of Moisture/Reflow Sensitive Surface Mount Devices). Moisture barrier bags (MBB) with desiccant are required for MSL ratings of 2 or greater. These sealed packages should not be broken until time of use. Once the original package is broken, the floor life of the product at conditions of $\leq 30^{\circ}\text{C}$ and 60% relative humidity varies according to the MSL rating (see J-STD-060A). The shelf life for dry packed SMT packages will be a minimum of 12 months from the bag seal date, when stored at the following conditions:

< 40°C , < 90% relative humidity.

Post Solder Cleaning and Drying considerations

Post solder cleaning is usually the final circuit board assembly process prior to electrical board testing. The result of inadequate cleaning and drying can affect both the reliability of a power module and the testability of the finished circuit board assembly. For guidance on appropriate soldering, cleaning and drying procedures, refer to OmniOn Board Mounted Power Modules: Soldering and Cleaning Application Note (AN04-001).

If additional information is needed, please consult with your OmniOn Sales representative for more details.

Technical Specifications (continued)

EMC Considerations

The circuit and plots in Figure 22 shows a suggested EN55032 Class A. For further information on designing for configuration to meet the conducted emission limits of EMC compliance, please refer to the FLT012A0Zdatasheet. C1 & C2 = 2.2uF 100V 1210

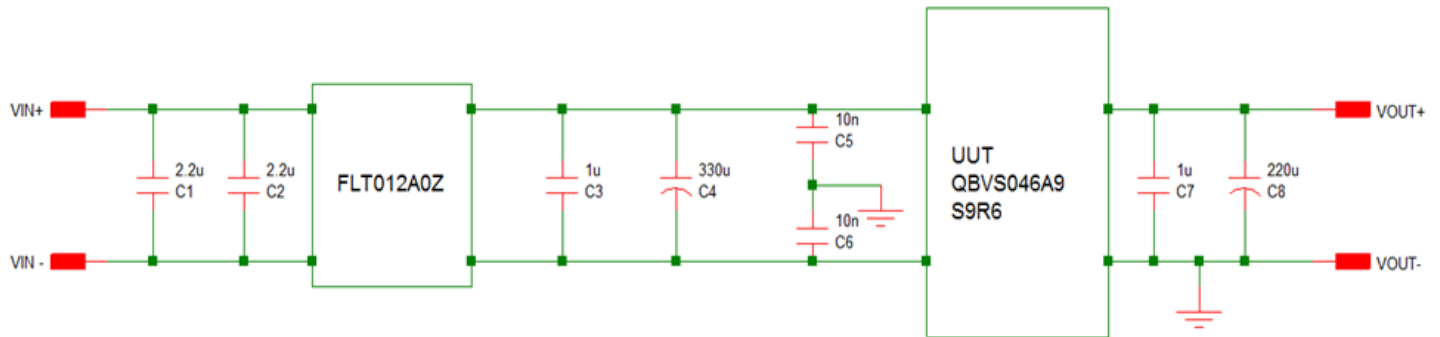

C3 & C7 = 1uF 100v 1210

C4 = 330uF 100V Nichicon VR series

C5 & C6 = 0.01uF 1500V 1210

C8 = 220uF 35V Nichicon PL series

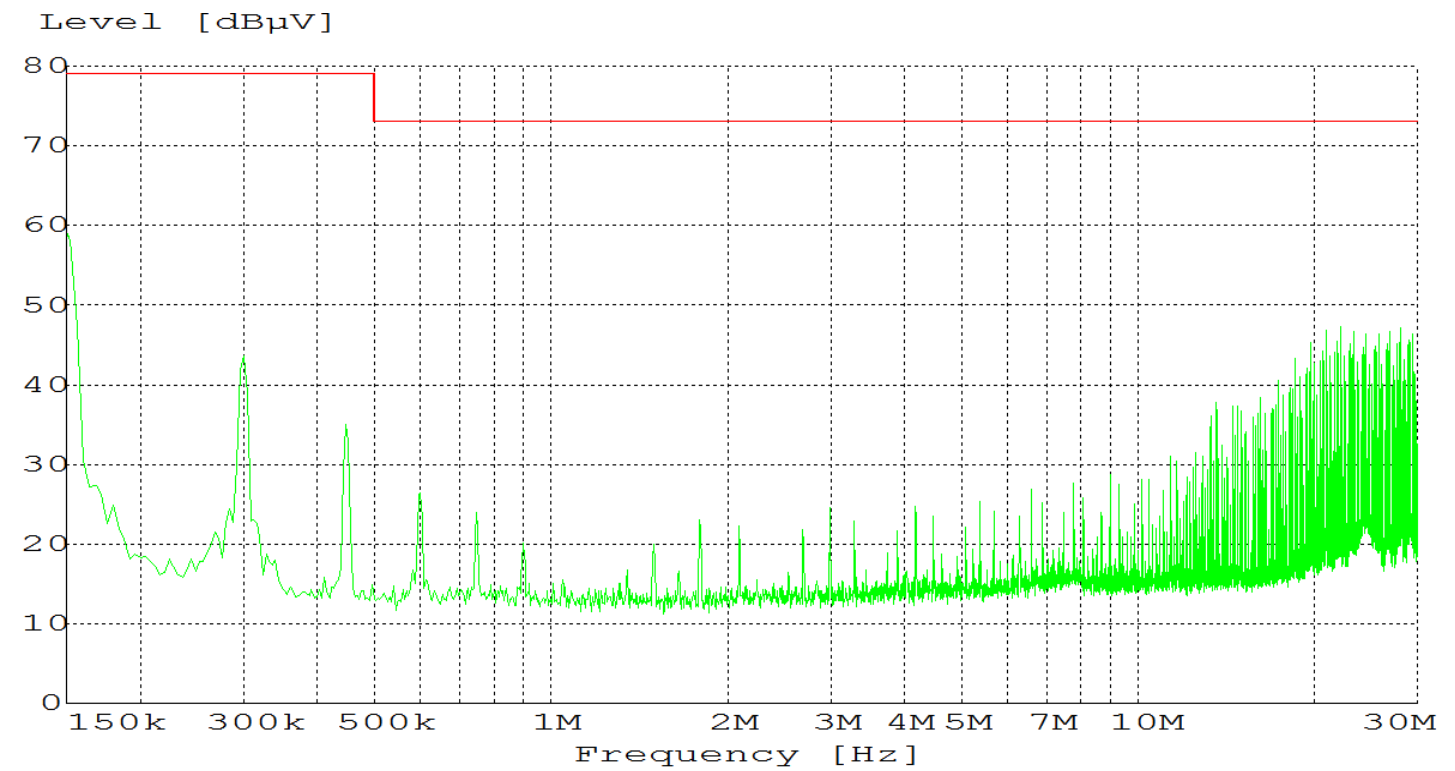

— MES pre PK
 — LIM EN 55022A V QP

Technical Specifications (continued)

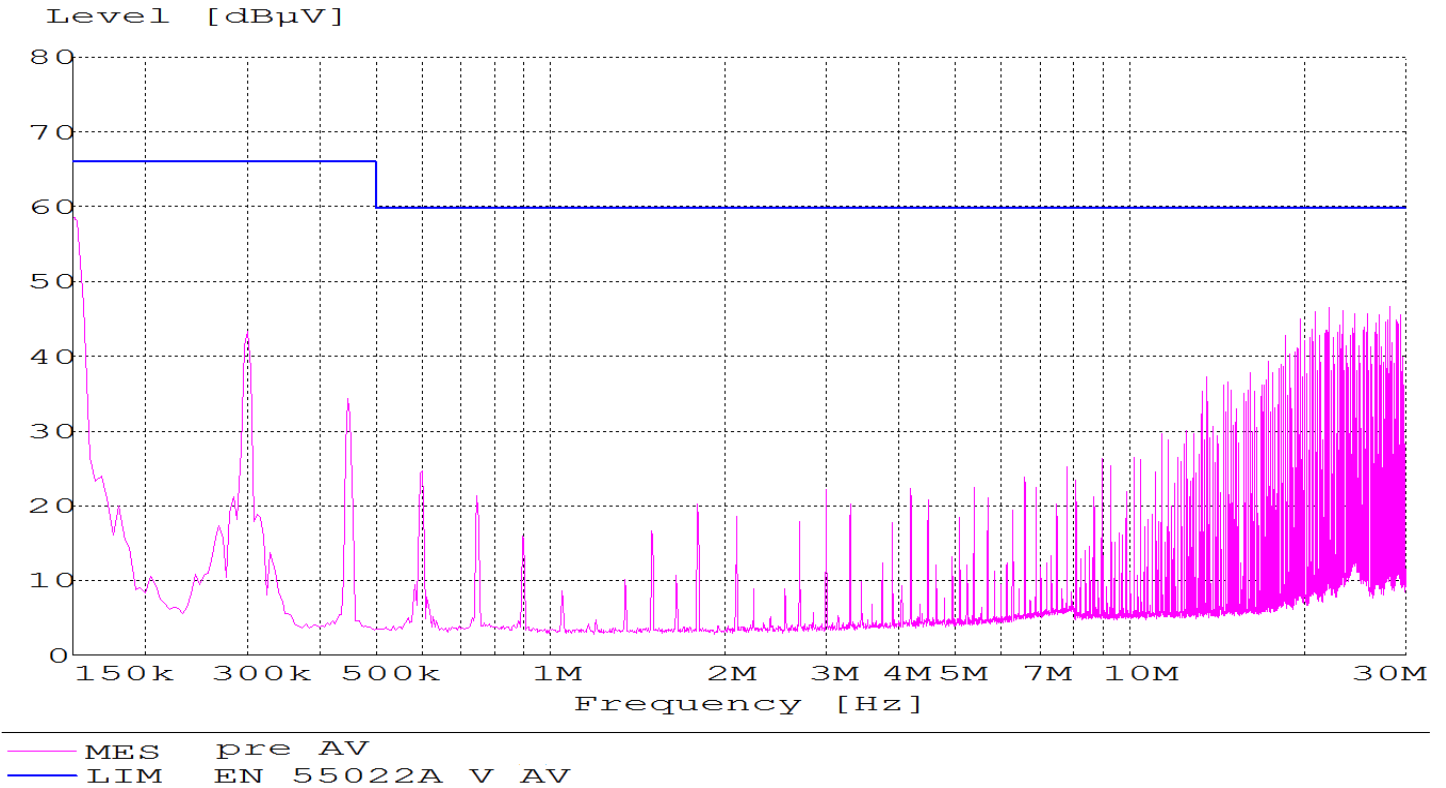

Figure 22. EMC Consideration

Mechanical Outline for QBVS046A9S9R6-H (Base Plate) Through-hole Module

Dimensions are in millimeters and [inches].

Tolerances: x.x mm ± 0.5 mm [x.xx in. ± 0.02 in.] (Unless otherwise indicated)

x.xx mm ± 0.25 mm [x.xxx in ± 0.010 in.]

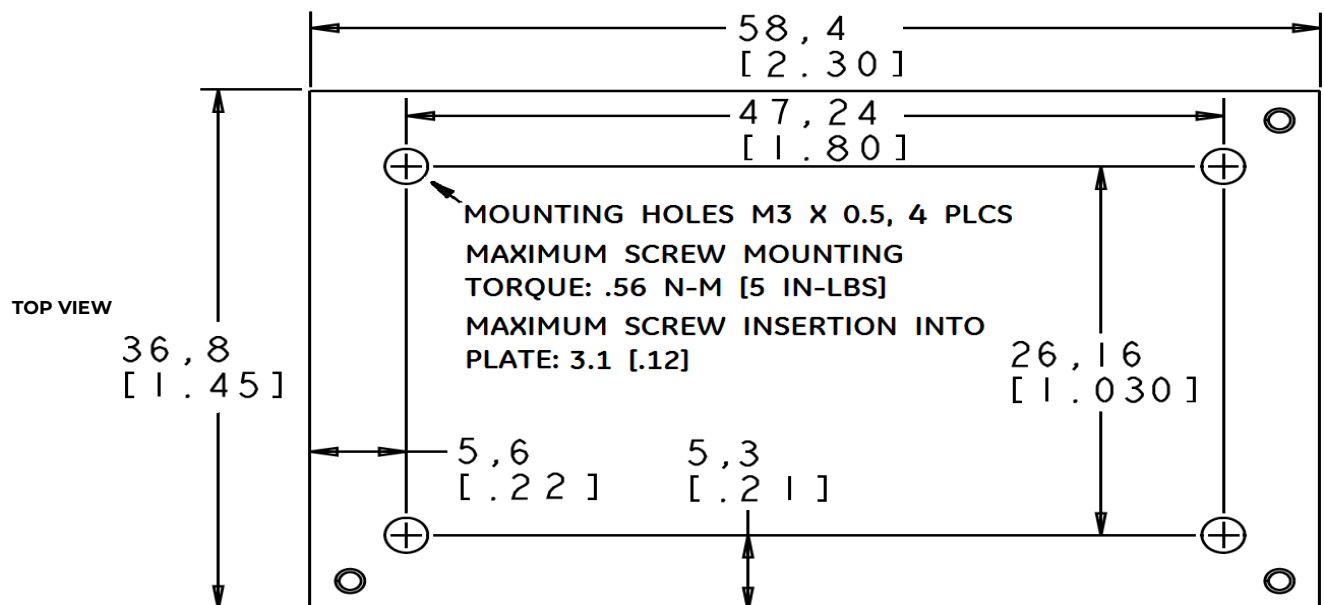

Technical Specifications (continued)

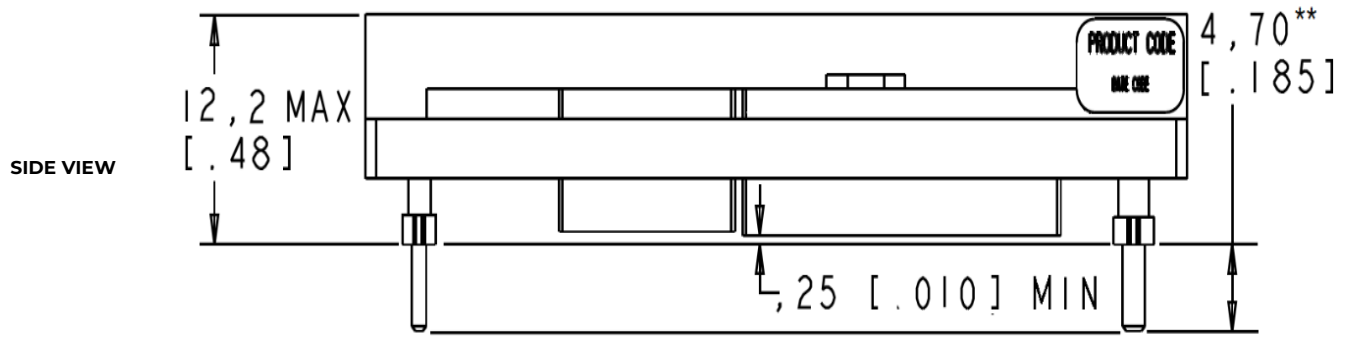

*Side label includes product designation, and data code

** Standard pin tail length. Optional pin tail lengths shown in Table 2, Device Options.

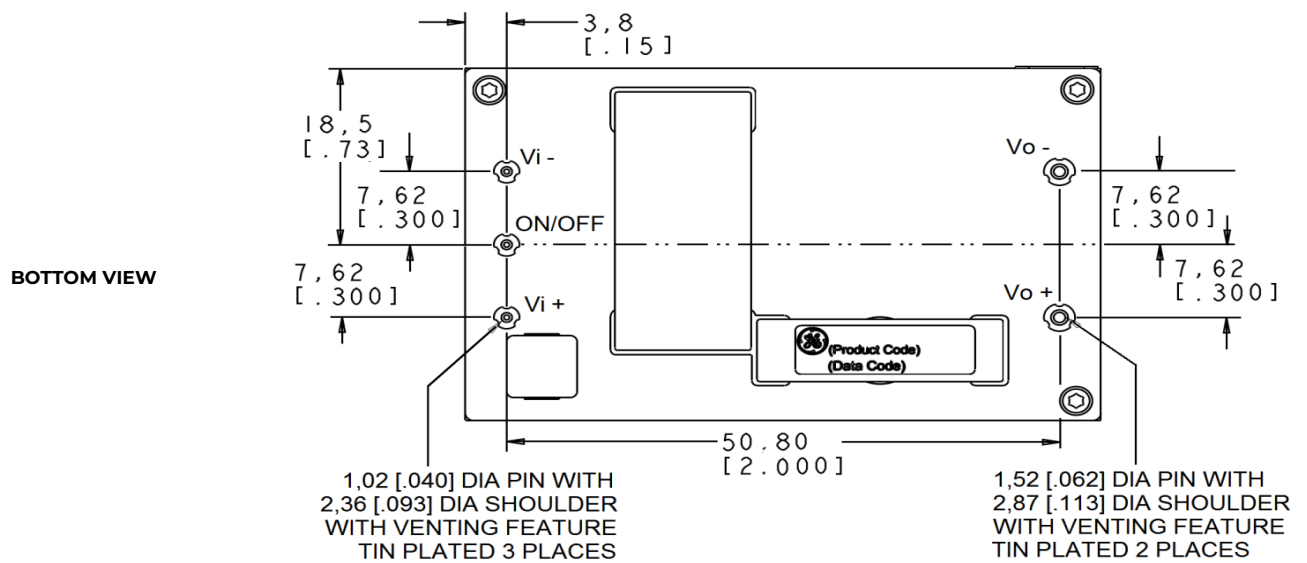

*Bottom side label includes OmniOn name, product designation, and data code

Pin Number	Pin Name
1	VIN(+)
2	ON/OFF
3	VIN(-)
4	VOUT(-)
8	VOUT(+)

Technical Specifications (continued)

Recommended Pad Layouts

Dimensions are in millimeters and (inches).

Tolerances: x.x mm ± 0.5 mm [x.xx in. ± 0.02 in.] (unless otherwise indicated)

x.xx mm ± 0.25 mm [x.xxx in ± 0.010 in.]

Through-Hole Modules

Pin Number	Pin Name
1	VIN(+)
2	ON/OFF
3	VIN(-)
4	VOU(-)
8	VOU(+)

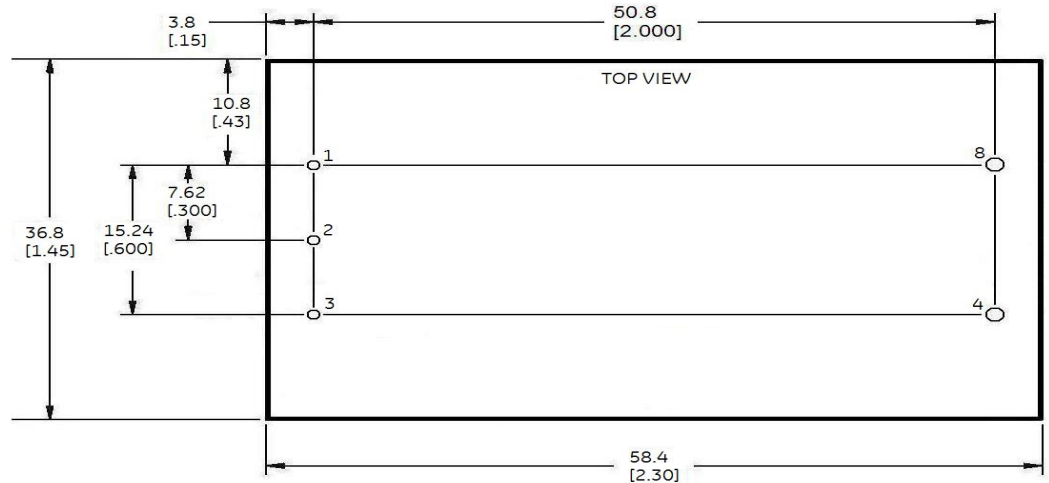

Hole and Pad diameter recommendations:

Pin Number	Hole Dia (mm)	Pad Dia (mm)
1,2,3	1.6	2.1
4,8	2.2	3.2

Packaging Details

All versions of the QBVS046A9S9R6 are supplied as standard in the plastic trays shown in Figure 23. Each tray contains a total of 12 power modules. The trays are self-stacking and each shipping box for the QBVS046A9S9R6 module contains 2 full trays plus one empty hold-down tray giving a total number of 24 power modules.

Tray Specification

Material	PET (1mm)
Max surface resistivity	10 ⁹ -10 ¹¹ Ω/PET
Color	Clear
Capacity	12 power modules
Standard packing quantity	24 pcs (1 box of 2 full trays + 1 empty top tray)

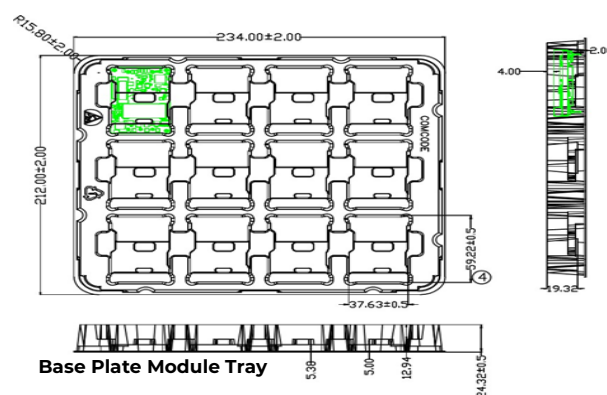

Figure 23. QBVS046A9S9R6 Packaging Tray

Technical Specifications (continued)

Ordering Information

Please contact your OmniOn Sales Representative for pricing, availability and optional features.

Table 1. Device Codes

Product codes	Input Voltage	Output Voltage	Output Current	Efficiency	Connector Type	MSL Rating	Com codes
QBVS046A9S9R6641-PHZ	50/54V (45-55Vdc)	9.6V	46.9A	96%	Through hole	2a	150033680s

Table 2. Device Options

	Characteristic	Character and position	Defination
Ratings	Form Factor	Q	Q=Quarter Brick
	Family Designator	BV	BV= BARRACUDA Series, Without PMBus interface
	Input Voltage	S	S=Special Range,50/54V (45V-55V)
	Output Power	046A9	046A9=046.9 Amps Maximum Output Current
	Output Voltage	S9R6	S9R6=9.6V nominal
Options	Pin Length	6	Omit= Default Pin Length shown in mechanical Outline Figures 6= Pin Length: 3.68 mm +/- 0.25mm (0.145 in.+/- 0.010 in.)
	Action following Protective Shutdown	4	4= Auto- restart following shutdown (Overcurrent/ Overvoltage)
	On/Off Logic	1	1=Negative Logic
	Features	P H	P= Forced Droop Output for in parallel application (must be ordered) H=Heat plate, for use with heat sinks or cold-walls (must be ordered)
	RoHS	Z	Z=RoHS Complaint

Change History (excludes grammar & clarifications)

Revision	Date	Description of the change
1.4	06/17/2022	Updated ROHS
1.5	11/23/2023	Updated as per OmniOn template

OmniOn Power Inc.

601 Shiloh Rd.
Plano, TX USA

omnionpower.com

We reserve the right to make technical changes or modify the contents of this document without prior notice. OmniOn Power does not accept any responsibility for errors or lack of information in this document and makes no warranty with respect to and assumes no liability as a result of any use of information in this document.

We reserve all rights in this document and in the subject matter and illustrations contained therein. Any reproduction, disclosure to third parties or utilization of its contents – in whole or in parts – is forbidden without prior written consent of OmniOn Power. This document does not convey license to any patent or any intellectual property right. Copyright© 2023 OmniOn Power Inc. All rights reserved.