

## DATASHEET

# QBDS108A0B41-PHZ: Barracuda\* DC-DC Converter

48 to 60V<sub>DC</sub> input; 12V<sub>DC</sub> output; 108A output current

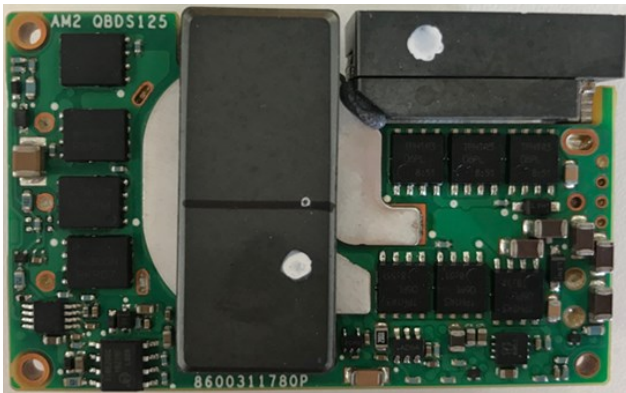

RoHS Compliant

## Application

- Distributed power architectures
- Intermediate bus voltage applications
- Networking equipment
- Servers and storage applications
- Supercomputers
- Automatic Test Equipment

## Features

- Compliant to RoHS Directive 2011/65/EU and amended Directive (EU) 2015/863
- Compliant to REACH Directive (EC) No 1907/2006
- High and flat efficiency with peak efficiency 97%
- Input voltage range: 48-60Vdc
- Delivers up to 1300W output power
- Low output ripple and noise
- Industry standard, modified-DOSA Digital Quarter Brick: 58.4mm x 36.8mm x 14.5 mm (2.30in x 1.45in x 0.60in)
- Constant switching frequency
- Remote On/Off control
- Output over current/voltage protection
- Digital interface with PMBus™ Rev.1.2 compliance
- Black box
- Over temperature protection
- Pre-bias startup
- Wide operating temperature range: -5°C to 85°C, continuous
- ANSI/UL# 62368-1 and CAN/CSA† C22.2 No. 62368-1 Recognized, DIN VDE‡ 0868-1/A11:2017 (EN62368-1:2014/A11:2017)
- ISO\*\* 9001 and ISO 14001 certified manufacturing facilities
- Base plate (-H=option code, always required)
- Class II, Category 2, Isolated DC/DC Converter (IPC-9592B)

The QBDS108A0B41 Barracuda™ series of dc-dc converters is a new generation of fully regulated DC/DC power modules designed to support 12Vdc intermediate bus applications. The QBDS108A0B series operate from an input voltage range of 48 to 60Vdc and provide up to 1300W output power in an industry-standard, modified DOSA digital quarter brick. The converter incorporates digital control, synchronous rectification technology, a fully regulated control topology, and innovative packaging techniques to achieve full load efficiency exceeding 97% at 12dc output. Standard features include a heat plate to attach external heat sinks or contact a cold wall, on/off control, output overcurrent and over voltage protection, over temperature protection, input under and over voltage lockout and PMBus interface. The output is fully isolated from the input, allowing versatile polarity configurations and grounding connections.

\* UL is a registered trademark of Underwriters Laboratories, Inc.

† CSA is a registered trademark of Canadian Standards Association.

‡ VDE is a trademark of Verband Deutscher Elektrotechniker e.V.

\*\* ISO is a registered trademark of the International Organization of Standards # The PMBus name and logo are registered trademarks of the System Management Interface Forum (SMIF)

# Technical Specifications

## Absolute Maximum Ratings

Stresses in excess of the absolute maximum ratings can cause permanent damage to the device. These are absolute stress ratings only, functional operation of the device is not implied at these or any other conditions in excess of those given in the operations sections of the data sheet. Exposure to absolute maximum ratings for extended periods can adversely affect the device reliability.

Parameter	Symbol	Min	Max	Unit
Input Voltage <sup>1</sup> Continuous	$V_{IN}$	-0.3	60	$V_{dc}$
$V_{ON/OFF}$ to $V_{IN}(-)$	$V_{ON/OFF}$	–	14.5	$V_{dc}$
ADDR to $V_{out}(-)$		-0.5	3.8	V
Operating Ambient Temperature Long-Term Operating	$T_A$	-5	85	°C
Short-Term Operating (96 hours/year)	$T_A$	-20	90	°C
Storage Temperature	$T_{stg}$	-40	100	°C
I/O Isolation Voltage <sup>2</sup> (100% factory Hi-Pot tested)	–	–	750	$V_{dc}$

<sup>1</sup> Input over voltage protection will shutdown the output voltage when the input voltage exceeds threshold level.

<sup>2</sup> Base plate is considered floating.

## Electrical Specifications

Unless otherwise indicated, specifications apply overall operating input voltage, resistive load, and temperature conditions.

Parameter	Device	Symbol	Min	Typ	Max	Unit
Operating Input Voltage		$V_{IN}$	48	54	60	$V_{dc}$
Maximum Input Current ( $V_{IN}=48V$ , $I_O=I_{O,max}$ )		$I_{IN,max}$	–	–	29	$A_{dc}$
Input No Load Current ( $V_{IN} = V_{IN,nom}$ , $I_O = 0$ , module enabled)	All	$I_{IN, No load}$		200		mA
Input Stand-by Current ( $V_{IN} = V_{IN,nom}$ , module disabled)	All	$I_{IN, stand-by}$			30	mA

## Technical Specifications (continued)

Parameter	Device	Symbol	Min	Typ	Max	Unit
External Input Capacitance	All		260	–	1300	μF
Inrush Transient (for fuse sizing*)	All	$I^2t$	–	–	1	A <sup>2</sup> s
Input Terminal Ripple Current (Measured at module input pin with maximum specified input capacitance and < 500uH inductance between voltage source and input capacitance) 5Hz to 20MHz, $V_{IN} = 54V$ , $I_O = I_{O,max}$	All		–	1300	–	mA <sub>rms</sub>
Input Ripple Rejection (120Hz)	All		–	25	–	dB
Output Voltage Set-point ( $V_{IN}=54V$ , $I_O=54A$ , $T_A=25^\circ C$ ) (not Adjustable via PMBus)	-P Option	$V_{O,set}$	11.88	12	12.12	V <sub>dc</sub>
Output Voltage (Over all operating input voltage (48V to 60V), resistive load, and temperature conditions until end of life)	-P Option	$V_O$	10.8	12	12.5	V <sub>dc</sub>
Output Voltage (Over all operating input voltage (51V to 60V), resistive load, and temperature conditions until end of life)	-P Option	$V_O$	11.5	12	12.5	V <sub>dc</sub>
Output Regulation [ $V_{IN, min}=51V$ ] Line ( $V_{IN} = V_{IN,min}$ to $V_{IN,max}$ ) Load ( $I_O=I_{O,min}$ to $I_{O,max}$ ), Intentional Droop Temperature ( $T_A = -5^\circ C$ to $+85^\circ C$ )	-P option -P option All		– – –	0.5 0.7 2	– – –	% $V_{O,set}$ V <sub>dc</sub> % $V_{O,set}$
Output Ripple and Noise, $C_O=1300 \mu F$ , ½ Ceramic, ½ PosCap or Oscon ( $V_{IN} = V_{IN,nom}$ and $I_O=I_{O,min}$ to $I_{O,max}$ ) RMS (5Hz to 20MHz bandwidth) Peak-to-Peak (5Hz to 20MHz bandwidth)	All		– –	50 –	– 150	mV <sub>rms</sub> mV <sub>pk-pk</sub>
External Output Capacitance (Typically 50% ceramic, 50% Oscon or POSCAP)	All	$C_{O,max}$	700	–	8125	μF
Output Power	All	$P_O$	0	–	1300	W
Output Current	All	$I_O$	0	–	108.3	A

## Technical Specifications (continued)

Parameter	Device	Symbol	Min	Typ	Max	Unit
VOUT_OC_FAULT_LIMIT (Adjustable via PMBus)	All	$I_{O,lim}$	–	130	–	A <sub>dc</sub>
Efficiency ( $V_{IN} = 54V, T_A = 25^{\circ}C$ )						
$I_O = 100\% I_{O,max}, V_O = V_{O,set}$	All	$\eta$		97.3		%
$I_O = 50\% I_{O,max}$ to $80\% I_{O,max}, V_O = V_{O,set}$	All	$\eta$		97.5		%
$I_O = 65\% I_{O,max}, V_O = V_{O,set}$ , Peak efficiency	All			97.7		%
Switching Frequency (Primary FETs)		fsw		160		kHz
Dynamic Load Response						
$dI_O/dt = 1A/\mu s; V_{in} = V_{in,nom}; T_A = 25^{\circ}C;$						
Tested with a 1.0 $\mu$ F ceramic, and 5200 $\mu$ F low ESR Polymer capacitor at the load)						
Load Change from $I_O = 50\%$ to $75\%$ of $I_{O,max}$ :	All	$V_{pk}$	–	350	–	mV <sub>pk</sub>
Peak Deviation		$t_s$	–	300	–	ms
Settling Time ( $V_O < 10\%$ peak deviation)						
Load Change from $I_O = 75\%$ to $50\%$ of $I_{O,max}$ :	All	$V_{pk}$	–	350	–	mV <sub>pk</sub>
Peak Deviation		$t_s$	–	300	–	ms
Settling Time ( $V_O < 10\%$ peak deviation)						

## Isolation Specifications

Parameter	Symbol	Min	Typ	Max	Unit
Isolation Capacitance	$C_{iso}$	–	TBD	–	nF
Isolation Resistance	$R_{iso}$	10	–	–	M $\Omega$

## General Specifications

Parameter	Device	Symbol	Typ	Unit
Calculated Reliability Based upon Telcordia SR-332 Issue 3: Method I, Case 3, ( $I_O = 80\% I_{O,max}, T_C = 40^{\circ}C, \text{Airflow} = 200 \text{ LFM}$ ), 90% confidence	All	MTBF	8,715,836	Hours
	All	FIT	TBD	10 <sup>9</sup> /Hours
Weight – with Base plate			95g (3.4oz)	g (oz.)

## Technical Specifications (continued)

### Feature Specifications

Unless otherwise indicated, specifications apply overall operating input voltage, resistive load, and temperature conditions. See Feature Descriptions for additional information.

Parameter	Device	Symbol	Min	Typ	Max	Unit
Remote On/Off Signal Interface ( $V_{IN}=V_{IN,min}$ to $V_{IN,max}$ , Signal referenced to $V_{IN-}$ terminal) Negative Logic ("1" device code suffix): Logic Low = module On; Logic High = module Off Positive Logic (no device code suffix): Logic Low = module Off; Logic High = module On Logic Low (pull down to $V_{IN(-)}$ externally)						
Voltage	All	$V_{on/off}$	–	–	0.8	V <sub>dc</sub>
Sink current	All	$I_{on/off}$	–	–	500	μA
Logic High (default; pulled up internally)						
Internal pull-up voltage	All	$V_{on/off}$	2.4	–	–	V <sub>dc</sub>
Optional external applied voltage	All	$V_{on/off}$	2.4	–	14.5	V <sub>dc</sub>
Leakage current of external pull-down device ( $V_{on/off} = 2.4V$ )	All	$I_{on/off}$	–	–	130	μA
Turn-On Delay and Rise Times ( $I_O=I_{O,max}$ , Adjustable via PMBus) $T_{delay}$ =Time until $V_O = 10\%$ of $V_{O,set}$ from either application of with Remote On/Off set to On (Enable with Vin); or operation of Remote On/Off from Off to On with Vin already applied for at least 30 milli-seconds (Enable with on/off).						
	-P option	$T_{delay,}$ Enable with Vin	–	–	30	ms
		$T_{delay,}$ Enable with on/off	–	–	5	ms
$T_{rise}$ =Time for $V_O$ to rise from 10% to 90% of $V_{O,set}$ , *Increased $T_{rise}$ for parallel modules when pre-bias $V_O$ exists at startup.	without	$T_{rise}$	–	15	–	ms
	-P option	$T_{rise}$	–	15*	–	ms
Over shoot at turn on					350	mV
Under shoot at turn off					350	mV
Load Sharing Current Balance (difference in output current across all modules with outputs in parallel, no load to full load)	-P option	$I_{diff}$	–	–	8	A <sub>dc</sub>

## Technical Specifications (continued)

Parameter	Device	Symbol	Min	Typ	Max	Unit
VOUT_COMMAND (Adjustable via PMBus)	All	$V_{O,set}$	9.5		12	V <sub>dc</sub>
VOUT_OV_FAULT_LIMIT (Adjustable via PMBus)	All	$V_{O,limit}$	–	$V_{O,set} + 3V$	–	V <sub>dc</sub>
Overtemperature Protection (Adjustable via PMBus)	All	$T_{OTP,set}$	–	128	–	°C
Input Undervoltage Lockout (Adjustable via PMBus)						
Turn-on Threshold			–	47	–	V <sub>dc</sub>
Turn-off Threshold			–	43	–	V <sub>dc</sub>
Hysteresis			2			V <sub>dc</sub>
Input Overvoltage Lockout (Adjustable via PMBus)						
Turn-off Threshold [VIN_OV_FAULT_LIMIT]			–	60	–	V <sub>dc</sub>
Turn-on Threshold			58		–	V <sub>dc</sub>

## Digital Interface Specifications

Unless otherwise indicated, specifications apply overall operating input voltage, resistive load, and temperature conditions. See Feature Descriptions for additional information.

Parameter	Conditions	Symbol	Min	Typ	Max	Unit
<b>PMBus Signal Interface Characteristics</b>						
Input High Voltage (CLK, DATA)		$V_{IH}$	2.1		3.6	V
Input Low Voltage (CLK, DATA)		$V_{IL}$			0.8	V
Input high level current (CLK, DATA)		$I_{IH}$	-10		10	μA
Input low level current (CLK, DATA)		$I_{IL}$	-10		10	μA
Output Low Voltage (CLK, DATA, SMBALERT#)		$V_{OL}$			0.4	V
Output Low internal sink current (CLK, DATA)	$V_{OL}=0.4V$	$I_{OL}$	4			mA
Output Low internal sink current (SMBALERT#)	$V_{OL}=0.4V$	$I_{OL}$	2			mA
Output high level internal leakage current (DATA, SMBALERT#)	$V_{OUT}=3.6V$	$I_{OH}$	0		10	μA
Pin capacitance		$C_O$		0.7		pF
PMBus Operating frequency range (* 5-10 kHz to accommodate hosts not supporting clock stretching)	Slave Mode	FPMB	5*		400	kHz

## Technical Specifications (continued)

Parameter	Conditions	Symbol	Min	Typ	Max	Unit
<b>Measurement System Characteristics</b>						
Output current reading range		$I_{OUT(RNG)}$	1.65		128	A
Output current reading blanking		$I_{OUT(BNK)}$	0		1.5875	A
Output current reading resolution		$I_{OUT(RES)}$		146		mA
Output current reading accuracy	$40A < I_{out} < 145A$	$I_{OUT(ACC)}$	-5	-1.4	3	%
Output current reading accuracy (absolute difference between actual and reported values)	$1.65A < I_{out} < 40A$	$I_{OUT(ACC)}$	-1.7		2.5	A
$V_{OUT}$ reading range		$V_{OUT(RNG)}$	0		15.9997	V
$V_{OUT}$ reading resolution		$V_{OUT(RES)}$		0.244		mV
$V_{OUT}$ reading accuracy		$V_{OUT(ACC)}$	-2	0.6	2	%
$V_{IN}$ reading range		$V_{IN(RNG)}$	0		127.875	V
$V_{IN}$ reading resolution		$V_{IN(RES)}$		125		mV
$V_{IN}$ reading accuracy		$V_{IN(ACC)}$	-4	0.8	4	%
Temperature reading resolution		$T_{(RES)}$		0.25		°C
Temperature reading accuracy		$T_{(ACC)}$	-5		5	%

# Technical Specifications (continued)

## Characteristic Curves, 12Vdc Output

The following figures provide typical characteristics for the QBDS108A0B41-PHZ (12V, 108A) at 25°C. The figures are identical for either positive or negative Remote On/Off logic.

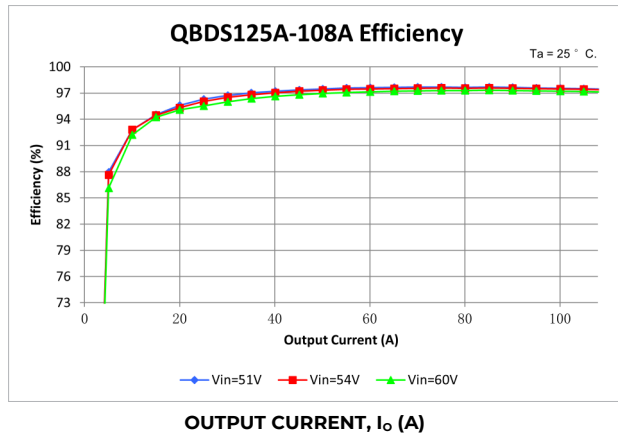

Figure 1. Converter Efficiency versus Output Current.

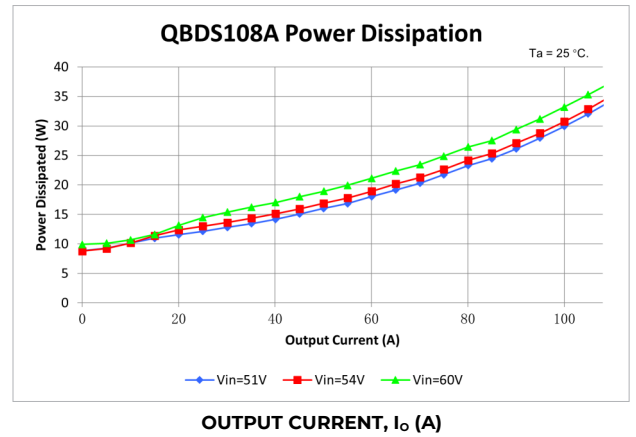

Figure 2. Derating Output Current versus Ambient Temperature and Airflow.

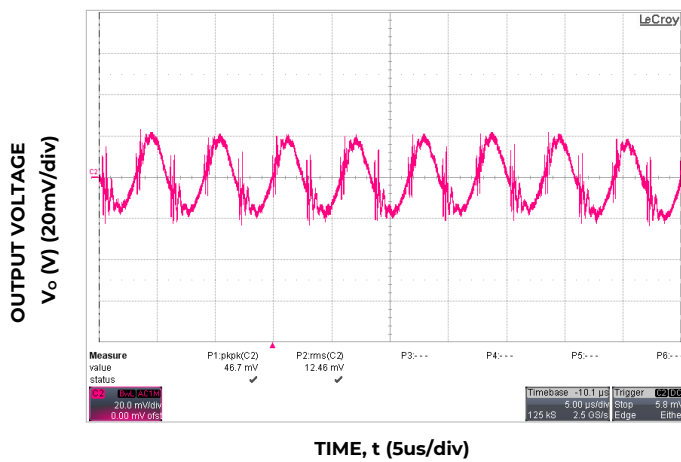

Figure 3. Typical output ripple and noise (C<sub>o</sub> = 650uF Ceramic + 650uF PosCap Oscon, V<sub>in</sub> = 54V, I<sub>o</sub> = I<sub>o,max</sub>).

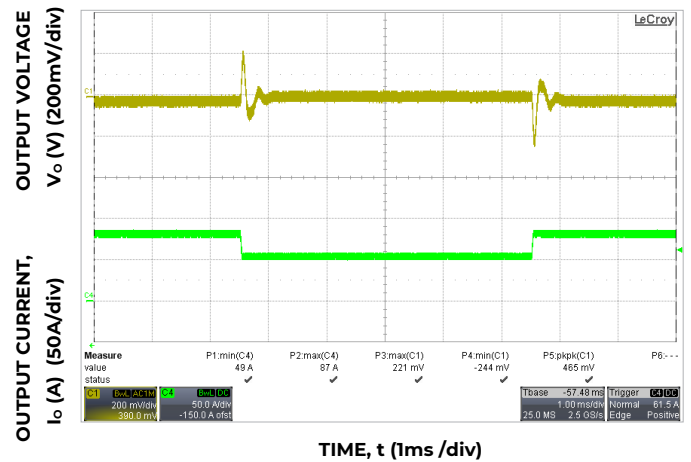

Figure 4. Dynamic Load Response,  $di_o/dt=1A/us$ ; V<sub>in</sub>=V<sub>in,nom</sub>; T<sub>A</sub>=25°C; Load Change from I<sub>o</sub> = 50% to 75% of I<sub>o,max</sub>; C<sub>o</sub> = 5200uF Ceramic;

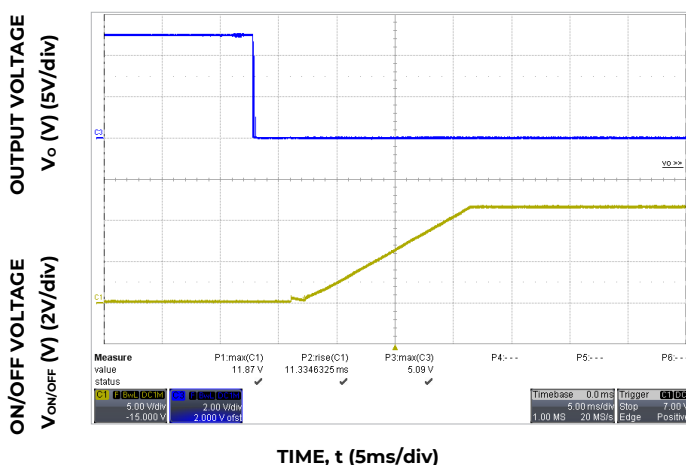

Figure 5. Typical Start-up Using On/Off Voltage (I<sub>o</sub> = I<sub>o,max</sub>).

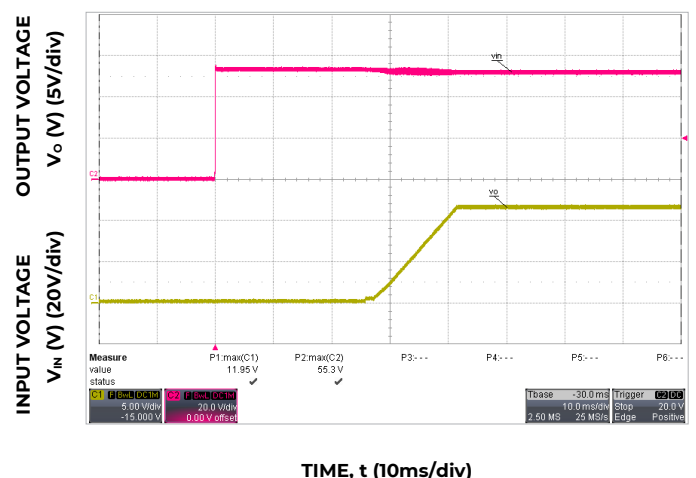

Figure 6. Typical Start-up Using Input Voltage (V<sub>in</sub> = 54V, I<sub>o</sub> = I<sub>o,max</sub>).



# Technical Specifications (continued)

## Characteristic Curves, 12Vdc Output

The following figures provide typical characteristics for the QBDS108A0B41-PHZ (12V, 108A) at 25°C. The figures are identical for either positive or negative Remote On/Off logic.

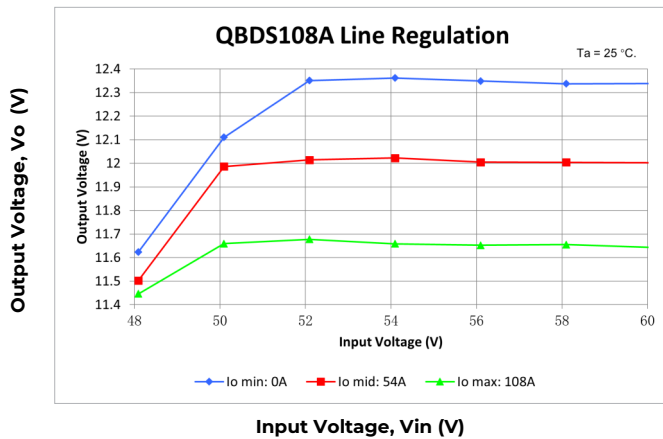

Figure 7. Typical Output Voltage Regulation vs Input Voltage

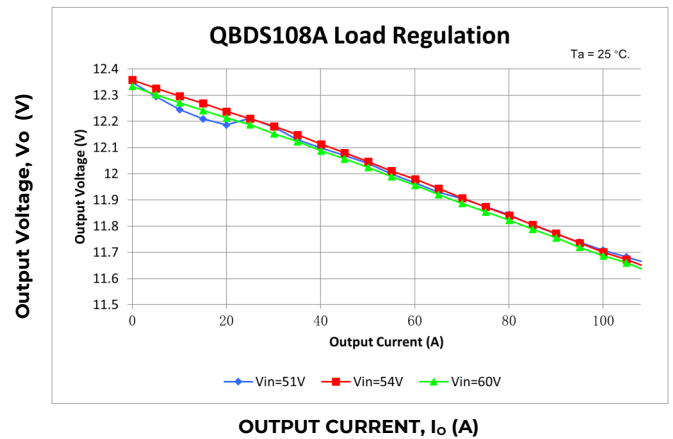
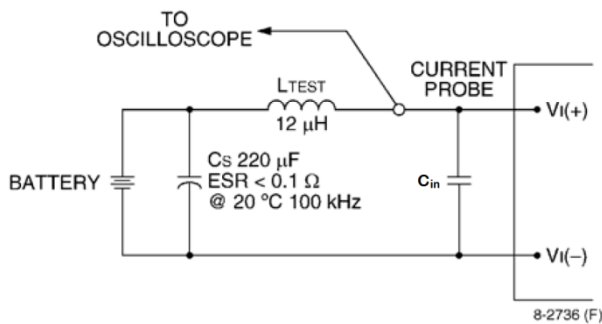

Figure 8. Typical Output Voltage Regulation vs Output Current

## Test Configurations



Note: Measure input reflected-ripple current with a simulated source inductance ( $L_{TEST}$ ) of 12  $\mu$ H. Capacitor CS offsets possible battery impedance. Measure current as shown above.

Figure 9. Input Reflected Ripple Current Test Setup.

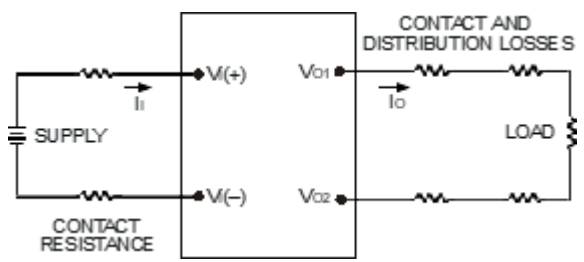

Note: All measurements are taken at the module terminals. When socketing, place Kelvin connections at module terminals to avoid measurement errors due to socket contact resistance.

$$\eta = \left( \frac{[V_{O(+)} - V_{O(-)}]I_{O}}{[V_{I(+)} - V_{I(-)}]I_{I}} \right) \times 100 \%$$

Figure 11. Output Voltage and Efficiency Test Setup.

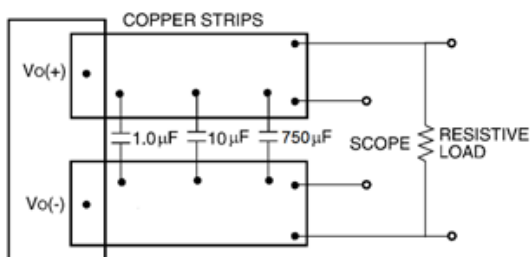

Note:

Use a 1.0  $\mu$ F ceramic capacitor, a 10  $\mu$ F aluminum or tantalum capacitor and a 750 polymer capacitor. Scope measurement should be made using a BNC socket. Position the load between 51 mm and 76 mm (2 in. and 3 in.) from the module.

Figure 10. Output Ripple and Noise Test Setup.

## Design Considerations

### Input Source Impedance

The power module should be connected to a low ac-impedance source. Highly inductive source impedance can affect the stability of the power module. For the test configuration in Figure 13, a 660 $\mu$ F electrolytic capacitor,  $C_{in}$ , (ESR<0.7 $\Omega$  at 100kHz), mounted close to the power module helps ensure the stability of the unit.

### Safety Considerations

For safety-agency approval of the system in which the power module is used, the power module must be installed in compliance with the spacing and separation requirements of the end-use safety agency

## Technical Specifications (continued)

standard, i.e., UL60950-1 2nd Ed., CSA C22.2 No. 60950-1 2nd Ed., and VDE0805-1 EN60950-1 2nd Ed.

If the input source is non-SELV (ELV or a hazardous voltage greater than 60 Vdc and less than or equal to 75Vdc), for the module's output to be considered as meeting the requirements for safety extra-low voltage (SELV), all of the following must be true:

The input source is to be provided with reinforced insulation from any other hazardous voltages, including the ac mains.

One VIN pin and one VOUT pin are to be grounded, or both the input and output pins are to be kept floating.

The input pins of the module are not operator accessible.

Another SELV reliability test is conducted on the whole system (combination of supply source and subject module), as required by the safety agencies, to verify that under a single fault, hazardous voltages do not appear at the module's output.

**Note:** Do not ground either of the input pins of the module without grounding one of the output pins. This may allow a non-SELV voltage to appear between the output pins and ground.

The power module has safety extra-low voltage (SELV) outputs when all inputs are SELV.

The input to these units is to be provided with a maximum 30A fast-acting (or time-delay) fuse in the ungrounded input lead.

## Feature Descriptions

### Overcurrent Protection

To provide protection in a fault output overload condition, the module is equipped with internal current-limiting circuitry and can endure current limiting continuously. If the overcurrent condition causes the output voltage to fall greater than 3.0V from  $V_{o,set}$ , the module will shut down and remain latched off. The overcurrent latch is reset by either cycling the input power or by toggling the on/off pin for one second. If the output overload condition still exists when the module restarts, it will shut down again. This operation will continue indefinitely until the overcurrent condition is corrected.

A factory configured auto-restart option (with overcurrent and overvoltage auto-restart managed as a group) is also available. An auto-restart feature continually attempts to restore the operation until fault condition is cleared.

### Remote ON/OFF

The module contains a standard on/off control circuit reference to the VIN(-) terminal. Two factory configured remote on/off logic options are available. Positive logic remote on/off turns the module on during a logic-high voltage on the ON/OFF pin, and off during a logic low. Negative logic remote on/off turns the module off during a logic high, and on during a logic low. Negative logic, device code suffix "1," is the factory-preferred configuration.

The On/Off circuit is powered from an internal bias supply, derived from the input voltage terminals. To turn the power module on and off, the user must supply a switch to control the voltage between the On/Off terminal and the VIN(-) terminal ( $V_{on/off}$ ). The switch can be an open collector or equivalent (see Figure 16). The switch should maintain  $<0.8V$  while sinking up to  $200\mu A$ . During a logic high when the switch is off, the maximum allowable leakage current at  $V_{on/off} = 2.4V$  is  $130\mu A$ . If using an external voltage source, the maximum voltage  $V_{on/off}$  on the pin is 14.5V with respect to the VIN(-) terminal.

If not using the remote on/off feature, perform one of the following to turn the unit on:

For negative logic, short ON/OFF pin to VIN(-).

For positive logic: leave ON/OFF pin open.

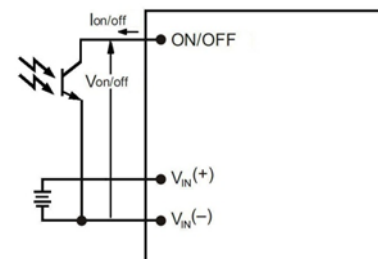

**Figure 12. Remote On/Off Implementation.**

### Output Overvoltage Protection

The module contains circuitry to detect and respond to output overvoltage conditions. If the overvoltage condition causes the output voltage to rise above the limit in the Specifications Table, the module will shut down and remain latched off. The overvoltage latch is reset by either cycling the input power, or by toggling the on/off pin for one second. If the output overvoltage condition still exists when the module restarts, it will shut down again. This operation will continue indefinitely until the overvoltage condition is corrected.

## Technical Specifications (continued)

A factory configured auto-restart option (with overcurrent and overvoltage auto-restart managed as a group) is also available. An auto-restart feature continually attempts to restore the operation until fault condition is cleared.

### Overtemperature Protection

These modules feature an overtemperature protection circuit to safeguard against thermal damage. The circuit shuts down the module when the maximum device reference temperature is exceeded. The module will automatically restart once the reference temperature cools by ~25°C.

### Input Under/Over voltage Lockout

At input voltages above or below the input under/over voltage lockout limits, module operation is disabled. The module will begin to operate when the input voltage level changes to within the under and overvoltage lockout limits. However recovery from input undervoltage may be delayed by 4 seconds, or 13 seconds if the module is hot.

### Load Sharing

For higher power requirements, the QBDS108A0B-P module offers an optional feature for parallel operation (-P Option code). This feature provides a precise forced output voltage load regulation droop characteristic. The output set point and droop slope are factory calibrated to ensure optimum matching of multiple modules' load regulation characteristics. To implement load sharing, the following requirements should be followed:

The VOUT(+) and VOUT(-) pins of all parallel modules must be connected together. Balance the trace resistance for each module's path to the output power planes, to ensure best load sharing and operating temperature balance.

VIN must remain between 45Vdc and 56Vdc for droop sharing to be functional.

It is permissible to use a common Remote On/Off signal to start all modules in parallel. However if spurious shutdowns occur at startup due to very low impedance between module outputs, the modules should be started sequentially instead, waiting at least the Turn-On Delay Time + Rise Time before starting the next module.

These modules contain means to block reverse current flow upon start-up, when output voltage is present from other parallel modules, thus eliminating the requirement for external output ORing devices. Modules with the -P option may automatically increase the Turn On delay, Tdelay, as specified in the Feature Specifications Table, if output voltage is present on the output bus at startup.

When parallel modules startup into a pre-biased output, e.g. partially discharged output capacitance, the Trise is automatically increased, as specified in the Feature Specifications Table, to ensure graceful startup.

Ensure that the total load is <50% IO,MAX (for a single module) until all parallel modules have started. Full load may be applied after Max Tdelay + Trise.

If fault tolerance is desired in parallel applications, output ORing devices should be used to prevent a single module failure from collapsing the load bus.

### Power Good, PG (option)

The QBDS108A0B41 module provides a Power Good (PG) option, which compares the module's output voltage to the module's POWER\_GOOD\_ON and POWER\_GOOD\_OFF values. These values are adjustable via PMBus. PG is asserted when the module's output voltage is above the POWER\_GOOD\_ON value, and PG is de-asserted if any condition such as overtemperature, overcurrent or loss of regulation occurs that would result in the output voltage going below the POWER\_GOOD\_OFF value.

The PG signal, provided on pin C2, is implemented with an open-drain node, pulled up via a 10kΩ resistor to 3.3V internally. For Positive Logic PG (default), the PG signal is HI, when PG is asserted, and LO, when the PG is de-asserted. For Negative Logic PG, the PG signal is LO, when PG is asserted, and HI, when the PG is de-asserted.

The PMBus command MFR\_PGGOOD\_POLARITY is used to set the logic polarity of the signal.

If not using the Power Good feature, the pin may be left N/C.

Default code is w/o PG pin.

Please contact OmniOn representative for this option

## Technical Specifications (continued)

### Thermal Considerations

The power modules operate in a variety of thermal environments and sufficient cooling should be provided to help ensure reliable operation. Thermal considerations include ambient temperature, airflow, module power dissipation, and the need for increased reliability. A reduction in the operating temperature of the module will result in an increase in reliability. Heat-dissipating components are mounted on the top side of the module. Heat is removed by conduction, convection and radiation to the surrounding environment. Proper cooling can be verified by measuring the thermal reference temperature (TH1).

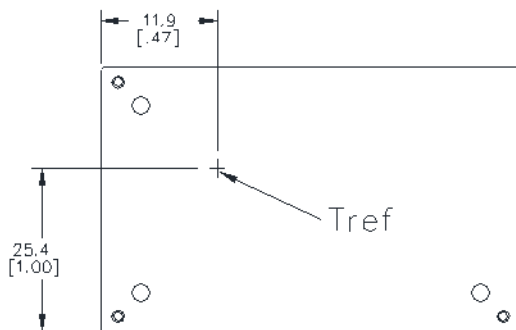

**Figure 13. Location of the thermal reference temperature TH1 for base plate module.**

Peak temperature occurs at the position indicated in Figure 13. For reliable operation, this temperature should not exceed  $TH1=105^{\circ}C$  at any airflow condition. For extremely high reliability you can limit this temperature to a lower value. The output power of the module should not exceed the rated power for the module as listed in the Ordering Information table, or the derated power for the actual operating conditions as indicated in Figs. 15-18.

### Heat Transfer via Convection

The thermal data presented here is based on physical measurements taken in a wind tunnel, using

automated thermo-couple instrumentation to monitor key component temperatures: FETs, diodes, control ICs, magnetic cores, ceramic capacitors, opto-isolators, and module PWB conductors, while controlling the ambient airflow rate and temperature. For a given airflow and ambient temperature, the module output power is increased, until one (or more) of the components reaches its maximum derated operating temperature, as defined in IPC-9592B. This procedure is then repeated for a different airflow or ambient temperature until a family of module output derating curves is obtained. Please refer to the Application Note “Thermal Characterization Process For Open-Frame Board-Mounted Power Modules” for a detailed discussion of thermal aspects including maximum device temperatures.

**Figure 14. Thermal Test Setup**

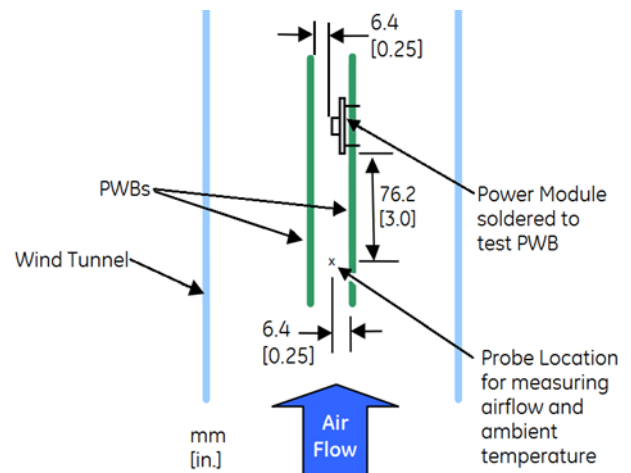

Increased airflow over the module enhances the heat transfer via convection. The thermal derating of figure 15-18 shows the maximum output current that can be delivered by each module in the indicated orientation without exceeding the maximum TH1 temperature versus local ambient temperature (TA) for several air flow conditions.

### Layout Considerations

The QBDS108A0B power module series are low profile in order to be used in fine pitch system card

# Technical Specifications (continued)

## Thermal Considerations

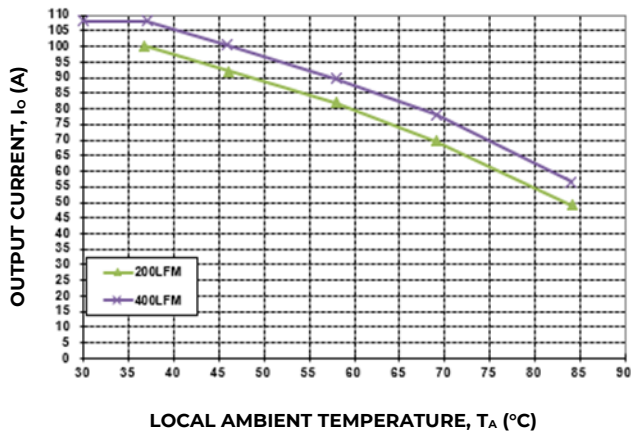

Figure 15. Output Current Derating for the Base Plate QBDS108A0B-H; Airflow Direction for Vout to Vin(Worst) orientation; Vin = 50V.

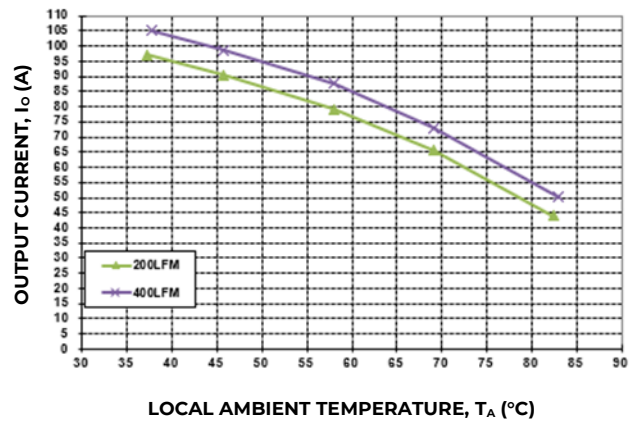

Figure 16. Output Current Derating for the Base Plate QBDS108A0B-H; Airflow Direction for Vout to Vin(Worst) orientation; Vin = 54V.

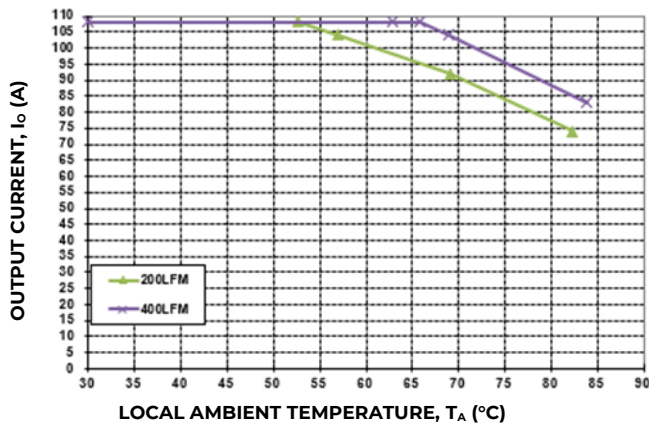

Figure 17. Output Current Derating for the Base plate QBDS108A0B-H+0.6" Heat Sink; Airflow Direction for Vout to Vin(Worst) orientation; Vin = 50V.

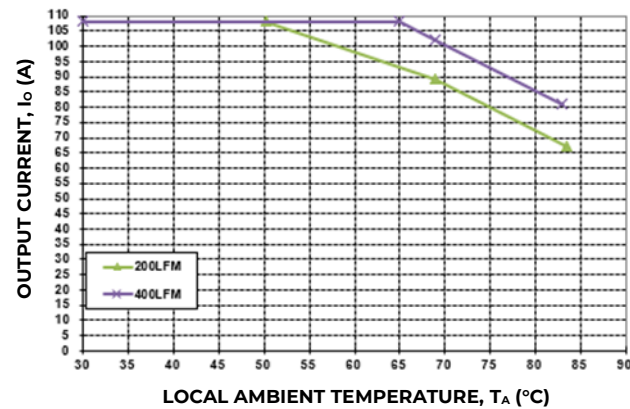

Figure 18. Output Current Derating for the Base plate QBDS108A0B-H+0.6" Heat Sink; Airflow Direction for Vout to Vin(Worst) orientation; Vin = 54V.

architectures. As such, component clearance between the bottom of the power module and the mounting board is limited. Avoid placing copper areas on the outer layer directly underneath the power module. Also avoid placing via interconnects underneath the power module.

For additional layout guide-lines, refer to FLT012A0Z Preliminary Data Sheet.

### Through-Hole Lead-Free Soldering Information

The RoHS-compliant, Z version, through-hole products use the SAC (Sn/Ag/Cu) Pb-free solder and RoHS-compliant components. The module is designed to be processed through single or dual wave soldering machines. The pins have a RoHS-compliant, pure tin finish that is compatible with both Pb and Pb-free wave soldering processes. A maximum preheat rate of 3°C/s is suggested. The wave preheat process should be such that the temperature of the power module board is kept below 210°C. For Pb solder, the recommended pot temperature is 260°C, while the Pb-free solder pot is 270°C max.

### Reflow Soldering

## Technical Specifications (continued)

The RoHS-compliant through-hole products can be processed with the following pin-in-paste (paste-in-hole) Pb or Pb-free reflow process.

Max. sustain temperature:

245°C (J-STD-020C Table 4-2: Packaging Thickness  $\geq 2.5\text{mm}$  / Volume  $> 2000\text{mm}^3$ ),

Peak temperature over 245°C is not suggested due to the potential reliability risk of components under continuous high-temperature.

Min. sustain duration above 217°C : 90 seconds

Min. sustain duration above 180°C : 150 seconds

Max. heat up rate: 3°C /sec

Max. cool down rate: 4°C C/sec

In compliance with JEDEC J-STD-020C spec for 2 times reflow requirement.

### Pb-free Reflow Profile

BMP module will comply with JEDEC J-STD-020 Rev. D (Moisture/Reflow Sensitivity Classification for

Non-hermetic Solid-State Surface Mount Devices) for both Pb-free solder profiles and MSL classification procedures.

BMP will comply with J-STD-020C specification for reflow up to 3 times. When removing a module, using localized hot air counts as one reflow, but using a solder pot instead to heat the pins does not count as a reflow.

The suggested Pb-free solder paste is Sn/Ag/Cu (SAC). The recommended linear reflow profile using Sn/Ag/Cu solder is shown in Figure 25.

### MSL Rating

The QBDS108A0B41 modules have a MSL rating as indicated in the Device Codes table, last page of this document.

### Storage and Handling

The recommended storage environment and handling procedures for moisture-sensitive surface mount packages is detailed in J-STD-033 Rev. A (Handling, Packing, Shipping and Use of Moisture/Reflow Sensitive Surface Mount Devices). Moisture barrier bags (MBB) with desiccant are required for MSL ratings of 2 or greater. These sealed packages should not be broken until time of use. Once the original package is broken, the floor life of the product at conditions of 30°C and 60% relative humidity varies according to the MSL rating (see J-STD-060A). The shelf life for dry packed SMT packages will be a minimum of 12 months from the bag seal date, when stored at the following conditions:  $< 40^\circ\text{C}$ ,  $< 90\%$  relative humidity.

### Post Solder Cleaning and Drying Considerations

Post solder cleaning is usually the final circuit board assembly process prior to electrical board testing. The result of inadequate cleaning and drying can affect both the reliability of a power module and the testability of the finished circuit board assembly. For guidance on appropriate soldering, cleaning and drying procedures, refer to GE Board Mounted Power Modules: Soldering and Cleaning Application Note (AN04-001).

If additional information is needed, please consult with your OmniOn Sales representative for more details

**Figure 19. Recommended linear reflow profile using Sn/Ag/Cu solder.**

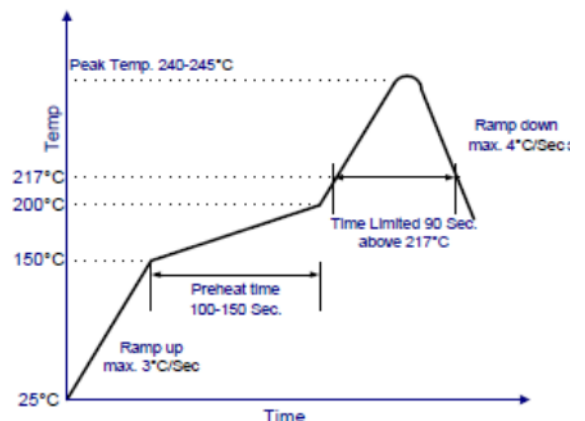

## Digital Feature Descriptions

# Technical Specifications (continued)

## EMC Considerations

The circuit and plots in Figure 20 shows a suggested configuration to meet the conducted emission limits of EN55032 Class B, test with 54Vin condition.

Discrete solution, with two stage CM chokes, and other external Cx, Cy.

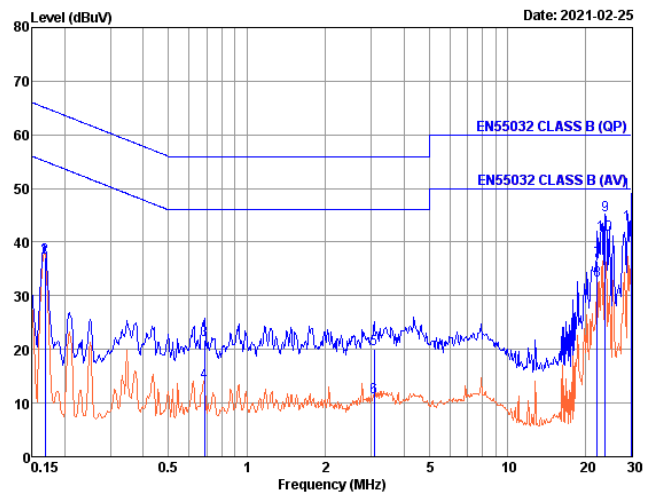
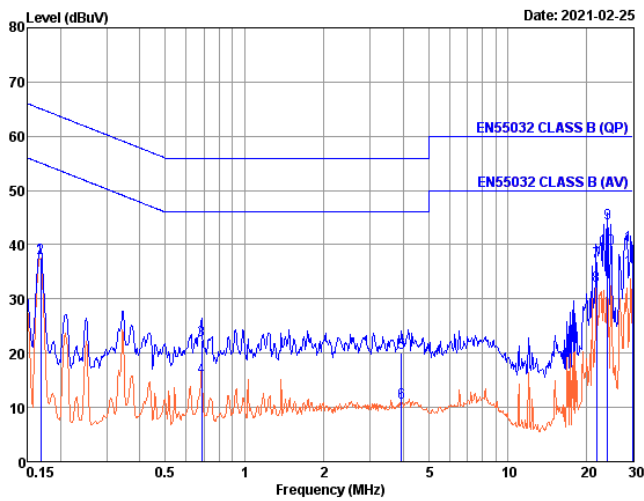
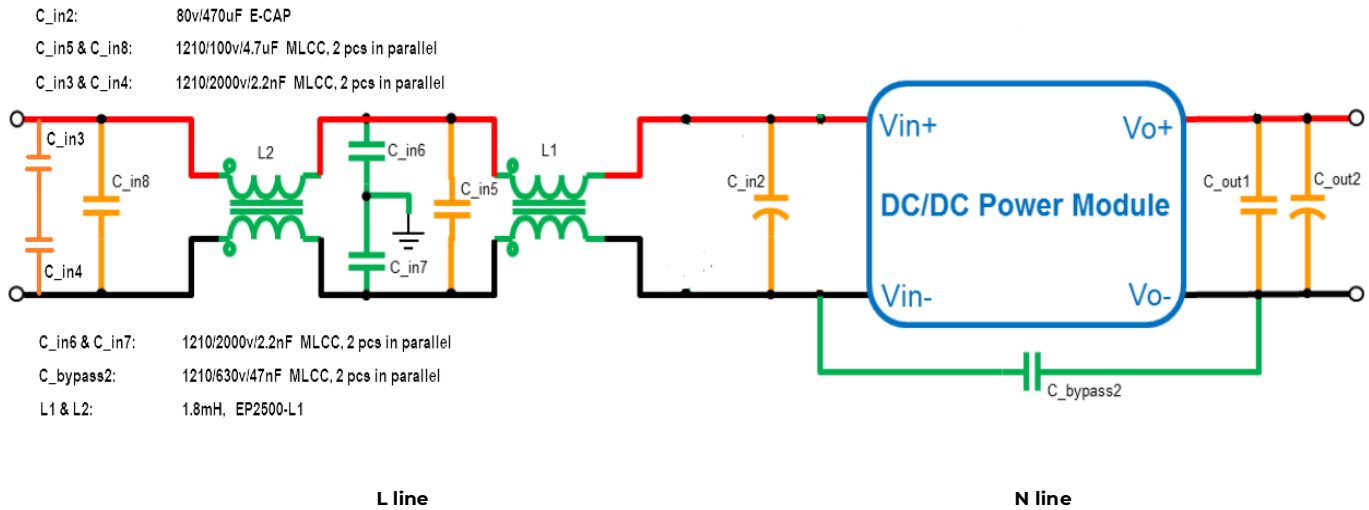

Site : Audix (Shanghai) Shielded 3  
 Condition : EN55032 CLASS B (QP) ENV4200-2020 LINE  
 Project No. :  
 Applicant :  
 EUT : QBDS108A0B41-62PHZ  
 M/N : 20CS31061345  
 S/N :  
 Power Supply : DC 54V  
 Ambient : 23°C/52%RH  
 Test Line : L  
 Test Mode : 12V 105A

Site : Audix (Shanghai) Shielded 3  
 Condition : EN55032 CLASS B (QP) ENV4200-2020 NEUTRAL  
 Project No. :  
 Applicant :  
 EUT : QBDS108A0B41-62PHZ  
 M/N : 20CS31061345  
 S/N :  
 Power Supply : DC 54V  
 Ambient : 23°C/52%RH  
 Test Line : N  
 Test Mode : 12V 105A

## Technical Specifications (continued)

### PMBus Interface Capability

The QBDS125A10R4 series is equipped with a digital PMBus interface to allow the module to be configured, and communicate with system controllers. Detailed timing and electrical characteristics of the PMBus can be found in the PMB Power Management Protocol Specification, Part 1, revision 1.2, available at <http://pmbus.org>. The QBDS125A10R4 supports both the 100kHz and 400kHz bus timing requirements. The QBDS125A10R4 shall stretch the clock, as long as it does not exceed the maximum clock LO period of 35ms. The power module will check the Packet Error Checking scheme (PEC) byte, if provided by the PMBus master, and include a PEC byte in all responses to the master. However, the power module does not require a PEC byte from the PMBus master.

The power module supports a subset of the commands in the PMBus 1.2 specification. Most all of the controller parameters can be programmed using the PMBus and stored as defaults for later use. All commands that require data input or output use the linear format. The exponent of the data words is fixed at a reasonable value for the command and altering the exponent is not supported. Direct format data input or output is not supported by the power module. The supported commands are described in greater detail below.

The power module contains non-volatile memory that is used to store configuration settings and scale factors. The settings programmed into the device are not automatically saved into this non-volatile memory though. The STORE\_DEFAULT\_ALL command must be used to commit the current settings to non-volatile memory as device defaults. The settings that are capable of being stored in non-volatile memory are noted in their detailed descriptions.

### SMBALERT Interface Capability

The power module also supports the SMBALERT response protocol. The SMBALERT response protocol is a mechanism through which the power module can alert the PMBus master that it has an active status or alarm condition via pulling the SMBALERT pin to an active low. The master processes this condition, and simultaneously addresses all slaves on the PMBus through the Alert Response Address. Only the slave(s) that caused the alert (and that support the protocol)

acknowledges this request. The master performs a modified receive byte operation to get the slave's address. At this point, the master can use the PMBus status commands to query the slave that caused the alert. Note: The power module can only respond to a single address at any given time. Therefore, the factory default state for the power module is to retain its resistor programmed address, when it is in an ALERT active condition, and not respond to the ARA. This allows master systems, which do not support ARA, to continue to communicate with the slave power module using the programmed address, and using the various READ\_STATUS commands to determine the cause for the SMBALERT. The CLEAR\_FAULTS command will retire the active SMBALERT. However, when the power module is used in systems that do support ARA, Bit 4 of the MFR\_CPIN\_ARA\_CONFIG command can be used to reconfigure the module to utilize ARA. In this case, the power module will no longer respond to its programmed address, when in an ALERT active state. The master is expected to perform the modified received byte operation, and retire the ALERT active signal. At this time, the power module will return to its resistor programmed address, allowing normal master-slave communications to proceed. The power module does not contain capability to arbitrate data bus contention caused by multiple modules responding to the modified received byte operation. Therefore, when the ARA is used in a multiple module PMBus application, it is necessary to have the power module at the lowest programmed address in order for the host to properly determine all modules' address that are associated with an active SMBAlert. Please contact your GE sales representative for further assistance, and for more information on the SMBus alert response protocol, see the System Management Bus (SMBus) specification.

### PMBus Addressing

The power module has flexible PMBUS addressing capability. By connecting different resistors from Addr1 pin to GND pin, 14 possible addresses can be acquired. The 7bit PMBUS address is defined by the value of the resistor as shown in the table below, and +/-1% resistor accuracy is acceptable. If there is any resistance exceeding the requested range, address 127 will be returned. The address in table below is in decimal.



# Technical Specifications (continued)



PMBUS address	Resistor(Kohm)
96	10
97	15
98	21
99	28
100	35.7
101	45.3
102	56.2
103	69.8
104	88.7
105	107
106	130
107	158
108	191
109	232

Figure 20. showing connection of used to set

Circuit resistors the

PMBus address of the module.

The user must know which I2C addresses are reserved in a system for special functions and set the address of the module to avoid interfering with other system operations. Both 100kHz and 400kHz bus speeds are supported by the module. Connection for the PMBus interface should follow the High Power DC specifications given in section 3.1.3 in the SMBus specification V2.0 for the 400kHz bus speed or the Low Power DC specifications in section 3.1.2. The complete SMBus specification is available from the SMBus web site, [smbus.org](http://smbus.org).

## PMBus Data Formats

For commands that set or report any voltage thresholds related to output voltage (including VOUT\_COMMAND, VOUT\_MARGIN), the module supports the “VOUT linear” data format consisting of a two byte value with a 16-bit, unsigned mantissa, and a fixed exponent of -12. The format of the two data bytes is shown below:

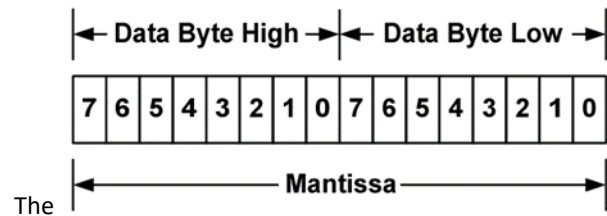

The

value of the number is then given by

$$\text{Value} = \text{Mantissa} \times 2^{-12}$$

For commands that set all other thresholds, voltages or report such quantities, the module supports the “linear” data format consisting of a two byte value with an 11-bit, two’s complement mantissa and a 5-bit, two’s complement exponent. The format of the two data bytes is shown below:

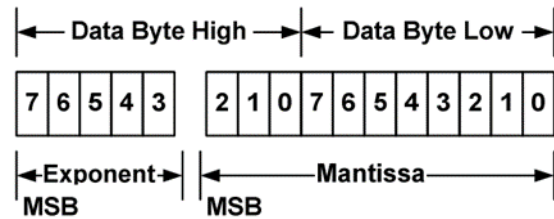

The value is of the number is then given by

$$\text{Value} = \text{Mantissa} \times 2^{\text{Exponent}}$$

For both formats, the “low” byte is transmitted first according to the PMBus and SMBus specifications.

## Write Protection

Write protection is enabled by default, to prevent accidentally changing settings. The MFR\_DEVICE\_TYPE (0xD0) command is used to disable or enable write protection as described below. To keep changes beyond the next removal of input voltage, the STORE\_DEFAULT\_ALL (0x11) command is used to save all settings to non-volatile memory.

## PMBus Enabled On/Off

The module can also be turned on and off via the PMBus interface. The OPERATION command is used to actually turn the module on and off via the PMBus, while the ON\_OFF\_CONFIG command configures the combination of analog ON/OFF pin input and PMBus commands needed to turn the module on and off. Bit [7] in the OPERATION command data byte enables the module, with the following functions:

## Technical Specifications (continued)

- 0 : Output is disabled
- 1 : Output is enabled

This module uses the lower five bits of the ON\_OFF\_CONFIG data byte to set various ON/OFF options as follows:

Bit Position	4	3	2	1	0
Access	r	r/w	r	r	r
Function	PU	CMD	CPR	POL	CPA
Default Value	1	1	1	1	1

PU: Factory set to 1. QBDS108A0B requires On/Off(i) pin to be connected to proper input rail for module to power up. This bit is used together with the CMD, CPR and ON bits to determine startup.

Bit Value	Action
1	Module does not power up until commanded by the analog ON/OFF pin and the OPERATION command as programmed in bits [2:0] of the ON_OFF_CONFIG register.

CMD: The CMD bit controls how the device responds to the OPERATION command.

Bit Value	Action
0	Module ignores the ON bit in the OPERATION command
1	Module responds to the ON bit in the OPERATION command

CPR: Factory set to 1. QBDS108A0B requires On/Off(i) pin to be connected to proper input rail for module to power up. This bit is used together with the CMD and ON bits to determine startup.

Bit Value	Action
1	Module requires the analog ON/OFF pin to be asserted to start the unit

### PMBus Adjustable Input Undervoltage Lockout

The module allows adjustment of the input under voltage lockout and hysteresis. The command VIN\_ON allows setting the input voltage turn on threshold, while the VIN\_OFF command sets the input voltage turn off threshold. For both the VIN\_ON and VIN\_OFF

commands, possible values range from 32.000 to 46.000V in 0.125V steps. VIN\_ON must be 2.000V greater than VIN\_OFF.

Both the VIN\_ON and VIN\_OFF commands use the “Linear” format with two data bytes. The upper five bits [7:3] of the high data byte form the two’s complement representation of the exponent, which is fixed at –3 (decimal). The remaining 11 bits are used for two’s complement representation of the mantissa, with the 11th bit fixed at zero since only positive numbers are valid. The data associated with VIN\_ON and VIN\_OFF can be stored to non-volatile memory using the STORE\_DEFAULT\_ALL command.

### PMBus Adjustable Soft Start Delay and Rise Time

The soft start delay and rise time can be adjusted in the module via PMBus. The TON\_DELAY command sets the delay time in ms, and allows choosing delay times between 10ms and 500ms, with resolution of 0.5ms. The TON\_RISE command sets the rise time in ms, and allows choosing soft start times between 15ms and 500ms, with resolution of 0.5ms. When setting TON\_RISE, make sure that the charging current for output capacitors can be delivered by the module in addition to any load current to avoid nuisance tripping of the overcurrent protection circuitry during startup. Both the TON\_RISE and TON\_DELAY commands use the “Linear” format with two data bytes. The upper five bits [7:3] of the high data byte form the two’s complement representation of the exponent, which is fixed at –1 (decimal). The remaining 11 bits are used for two’s complement representation of the mantissa, with the 11th bit fixed at zero since only positive numbers are valid. The data associated with TON\_RISE and TON\_DELAY can be stored to non-volatile memory using the STORE\_DEFAULT\_ALL command.

### Output Voltage Adjustment Using the PMBus

The power module output voltage set point is adjusted using the VOUT\_COMMAND. The output voltage setting uses the Linear data format, with the 16 bits of the VOUT\_COMMAND formatted as an unsigned mantissa, and a fixed exponent of -12 (decimal) (read from VOUT\_MODE).

$$VOUT = \text{Mantissa} \times 2^{-12}$$

## Technical Specifications (continued)

The range limits for VOUT\_COMMAND are 9.5V to 12V, and the resolution is 0.244mV.

The data associated with VOUT\_COMMAND can be stored to non-volatile memory using the STORE\_DEFAULT\_ALL command.

### Output Voltage Margining Using the PMBus

The power module can also have its output voltage margined via PMBus commands. The command VOUT\_MARGIN\_HIGH sets the margin high voltage, while the command VOUT\_MARGIN\_LOW sets the margin low voltage. Both the VOUT\_MARGIN\_HIGH and VOUT\_MARGIN\_LOW commands use the “Linear” mode with the exponent fixed at -12 (decimal). The data associated with VOUT\_MARGIN\_HIGH and VOUT\_MARGIN\_LOW can be stored to non-volatile memory using the STORE\_DEFAULT\_ALL command.

The module is commanded to go to the margined high or low voltages using the OPERATION command. Bits [5:2] are used to enable margining as follows:

00XX	:	Margin Off
0110	:	Margin Low (Act on Fault)
1010	:	Margin High (Act on Fault)

### Measuring Output Voltage Using the PMBus

The module can provide output voltage information using the READ\_VOUT command. The command returns two bytes of data in the linear format, with the 16 bits of the READ\_VOUT formatted as an unsigned mantissa, and a fixed exponent of -12 (decimal).

During module manufacture, an offset correction value is written into the non-volatile memory of the module to null errors in the tolerance and A/D conversion of VOUT. The command MFR\_VOUT\_READ\_CAL\_OFFSET can be used to read the offset - two bytes consisting of a signed 16-bit mantissa in two’s complement format, using a fixed exponent of -12 (decimal). The resolution is 0.244mV. The corrected Output voltage reading is then given by:

$$V_{OUT}(\text{Read}) = [V_{OUT}(A/D) + MFR\_VOUT\_READ\_CAL\_OFFSET]$$

### Measuring Input Voltage Using the PMBus

The module can provide input voltage information using the READ\_VIN command. The command returns two bytes of data in the linear format. The upper five bits [7:3] of the high data byte form the

two’s complement representation of the exponent, which is fixed at -3 (decimal). The remaining 11 bits are used for two’s complement representation of the mantissa, with the 11th bit fixed at zero since only positive numbers are valid.

During module manufacture, offset and gain correction values are written into the non-volatile memory of the module to null errors in the tolerance and A/D conversion of Vin. The command MFR\_VIN\_READ\_CAL\_OFFSET can be used to read the offset - two bytes consisting of a five-bit exponent (fixed at -3) and a 11-bit mantissa in two’s complement format. The resolution is 125mV. The command MFR\_VIN\_READ\_CAL\_GAIN can be used to read the gain correction - two bytes consisting of a unsigned 16 bit number. The resolution of this correction factor 0.000122. The corrected input voltage reading is then given by:

$$V_{IN}(\text{Read}) = [V_{IN}(A/D) \times (MFR\_VIN\_READ\_CAL\_GAIN / 8192)] + MFR\_VIN\_READ\_CAL\_OFFSET$$

### Measuring Output Current Using the PMBus

The module measures output current by using the output filter inductor winding resistance as a current sense element. The module can provide output current information using the READ\_IOUT command. The command returns two bytes of data in the linear format. The upper five bits [7:3] of the high data byte form the two’s complement representation of the

exponent, which is fixed at -3 (decimal). The remaining 11 bits are used for two’s complement representation of the mantissa, with the 11th bit fixed at zero since only positive numbers are valid. Output current readings are blanked below 1.65A.

During module manufacture, offset and gain correction values are written into the non-volatile memory of the module to null errors in the tolerance and A/D conversion of IOUT. The command MFR\_IOUT\_CAL\_OFFSET can be used to read the offset - two bytes consisting of a five-bit exponent (fixed at -3) and a 11-bit mantissa in two’s complement format. The resolution is 125mA. The command MFR\_IOUT\_CAL\_GAIN can be used to read the gain

## Technical Specifications (continued)

correction - two bytes consisting of a unsigned 16 bit number. The resolution of this correction factor 0.000122. The READ\_IOUT command provides module average output current information. This command only supports positive current sourced from the module. If the converter is sinking current a reading of 0 is provided.

$$I_{OUT}(\text{Read}) = [I_{OUT}(A/D) \times (MFR\_IOUT\_CAL\_GAIN / 8192)] + MFR\_IOUT\_CAL\_OFFSET$$

Note that the current reading provided by the module is corrected for temperature.

### Measuring the Temperature using the PMBus

The module can provide temperature information using the READ\_TEMPERATURE\_1 command. The command returns two bytes of data in the linear format. The upper five bits [7:3] of the high data byte form the two's complement representation of the exponent, which is fixed at -2 (decimal). The remaining 11 bits are used for two's complement representation of the mantissa.

Note that the module's temperature sensor is located close to the module hot spot TH1 (see Thermal Considerations) and is subjected to temperatures higher than the ambient air temperature near the module. The temperature reading will be highly influenced by module load and airflow conditions.

### Reading the Status of the Module using the PMBus

The module supports a number of status information commands implemented in PMBus. However, not all features are supported in these commands. A X in the FLAG cell indicates the bit is not supported.

STATUS\_WORD : Returns two bytes of information with a summary of the module's fault/warning conditions.

High Byte

Bit Position	Flag	Default Value
15	VOUT fault	0
14	IOUT fault or warning	0
13	Input Voltage fault	0
12	X	0
11	POWER_GOOD# (is negated)	0
10	X	0
9	X	0
8	X	0

Low Byte

Bit Position	Flag	Default Value
7	X	0
6	OFF	0
5	VOUT Overvoltage	0
4	IOUT Overcurrent	0
3	VIN Undervoltage	0
2	Temperature	0
1	CML (Comm. Memory Fault)	0
0	X	0

STATUS\_VOUT : Returns one byte of information relating to the status of the module's output voltage related faults.

Bit Position	Flag	Default Value
7	VOUT OV Fault	0
6	X	0
5	X	0
4	X	0
Bit Position	Flag	Default Value
3	X	0
2	X	0
1	X	0
0	X	0

## Technical Specifications (continued)

STATUS\_IOUT : Returns one byte of information relating to the status of the module's output current related faults.

Bit Position	Flag	Default Value
7	IOUT OC Fault	0
6	X	0
5	IOUT OC Warning	0
4	X	0
3	X	0
2	X	0
1	X	0
0	X	0

STATUS\_INPUT : Returns one byte of information relating to the status of the module's input voltage related faults.

Bit Position	Flag	Default Value
7	VIN OV Fault	0
6	X	0
5	X	0
4	VIN UV Fault	0
3	Module Off (Low VIN)	0
2	X	0
1	X	0
0	X	0

STATUS\_TEMPERATURE : Returns one byte of information relating to the status of the module's temperature related faults.

Bit Position	Flag	Default Value
7	OT Fault	0
6	OT Warning	0
5	X	0
4	X	0
3	X	0
2	X	0
1	X	0
0	X	0

STATUS\_CML : Returns one byte of information relating to the status of the module's communication related faults.

Bit Position	Flag	Default Value
7	Invalid/Unsupported Command	0
6	Invalid/Unsupported Data	0
5	Packet Error Check Failed	0
4	X	0
3	X	0
2	X	0
1	X	0
0	X	0

### Black box

There is a black box function realized by D-flash in power module, can record the latest 20 events including status registers, fault time, etc.

Please contact OmniOn representative for details.

## Technical Specifications (continued)

### Summary of Supported PMBus Commands

This section outlines the PMBus command support for the QBDS108A10B bus converters. Each supported command is outlined in order of increasing command codes with a quick reference table of all supported commands included at the end of the section.

Each command will have the following basic information.

#### Command Name [Code]

Definition

Data format

Factory default

Additional information may be provided if necessary.

#### OPERATION (0x01)

Command support: On/Off Immediate and Margins (Act on Fault). Soft off with sequencing not supported and Margins (Ignore Fault) not supported. Therefore bits 6, 3, 2, 1 and 0 set as read only at factory defaults

Format	8 bit unsigned (bit field)							
Bit Position	7	6	5	4	3	2	1	0
Access	r/w	r	r/w	r/w	r	r	r	r
Function	ON/OFF		Bits[5:4]		Bits[3:2]		N/A	
Default Value	1	0	0	0	1	0	0	0

#### ON\_OFF\_CONFIG (0x02)

Command support: Bit 1 polarity will be set based upon module code [0=Negative on/off logic, 1=positive on/off logic to allow customer system to know hardware on/off logic

#### CLEAR\_FAULTS (0x03)

Format	8 bit unsigned (bit field)							
Bit Position	7	6	5	4	3	2	1	0
Access	r	r	r	r	r	r/w	r	r
Function	(reserved)			Bit 4 pu	Bit 3 cmd	Bit 2 cpr	Bit 1 pol	Bit 0 cpa
Default Value	0	0	0	1	1	1	module code	1

Command support: All functionality

#### STORE\_DEFAULT\_ALL (0x11)

Command support: All functionality – Stores operating parameters to EEprom memory.

Command requires ≤ 500ms to execute. Delay any additional commands to module for sufficient time to complete execution.

#### VOUT\_MODE[0x20]

Command support: Supported. Factory default: 0x14 – indicates linear mode with exp = -12

## Detailed Description of Supported PMBus Commands

### VOUT\_COMMAND [0x21]

Format	8 bit unsigned (bit field)							
Bit Position	7	6	5	4	3	2	1	0
Access	r	r	r	r	r	r	r	r
Function	Mode (linear)				2's complement exponent			
Default Value	0	0	0	1	0	1	0	0

Data format: 16 bit unsigned mantissa (implied exponent per VOUT\_MODE)

Factory default: 12.000V (  $12.000/2^{-12} \rightarrow 49,152 = 0xC000$  ) [standard code]

Range limits (max/min): 12.000/9.500V

Units: volt

Command support: Supported

### VOUT\_CAL\_OFFSET [0x23]

Range limits (max/min): +0.25/-0.25

Units: volt

Command support: read/write support, lockout per MFR\_DEVICE\_TYPE, functionality implemented

### VOUT\_MARGIN\_HIGH [0x25]

Range limits (max/min): 13.200/8.100V

Units: volt

Command support: read/write support, full functionality except "Ignore faults".

Note: Range cross-check - value must be greater than VOUT\_MARGIN\_LOW value.

### VOUT\_MARGIN\_LOW [0x26]

Range limits (max/min): 13.200/8.100V

Units: volt

Command support: read/write support, full functionality except "Ignore faults".

Note: Range cross-check - value must be less than VOUT\_MARGIN\_HIGH value.

### VOUT\_DROOP [0x28]

Range limits (max/min): 50.0/0

Units: mv/A

Command support: All functionality

### VIN\_ON [0x35]

Range limits (max/min): 46/40

Units: volt

Command support: All functionality

Note: Special interlock checks between VIN\_ON and VIN\_OFF maintain a hysteresis gap of 2V minimum and do not allow the OFF level to be higher than and ON level

### VIN\_OFF [0x36]

Range limits (max/min): 46/40

Units: volt

Command support: All functionality

Note: Special interlock checks between VIN\_ON and VIN\_OFF maintain a hysteresis gap of 2V minimum and do not allow the OFF level to be higher than and ON level

### VOUT\_OV\_FAULT\_LIMIT [0x40]

Range limits (max/min): 15.99/10.9 (See note 2)

Units: volt

Page 23

## Detailed Description of Supported PMBus Commands

Command support: All functionality

Note:

1. Range cross-check – value must be greater than VOUT\_COMMAND value.
2. The maximum OV Fault Limit equals the output set point plus 3V, up to 15.99V. This is an automatic module protection feature that will override a user-set fault limit if the user limit is set too high.

### VOUT\_OV\_FAULT\_RESPONSE [0x41]

Command support:

- Response settings (bits RSP0:1) – only a setting of 10, unit shuts down and responds according to the retry settings below, is supported.
- Retry settings (bits RS0:2) – only settings of 000 (unit does not attempt to restart on fault) and 111 unit continuously restarts (normal startup) while fault is present until commanded off, bias power is removed or another fault condition causes the unit to shutdown.
- Delay time setting (bits 0-2) – only DT0:2 = 0 (no delay) supported.

Default Settings: The default settings for the VOUT\_OV\_FAULT\_RESPONSE command are;

- The unit shuts down in response to a VOUT over voltage condition.
- The unit will continuously restart (normal startup) while the VOUT over voltage condition is present until it is commanded off, bias power is removed or another fault condition causes the unit to shut down.
- The shutdown delay is set to 0 delay cycles.

### IOUT\_OC\_FAULT\_LIMIT [0x46]

Format	8 bit unsigned (bit field)							
Bit Position	7	6	5	4	3	2	1	0
Access	r	r	r/w	r/w	r/w	r	r	r
Function	RSP[1]	RSP[0]	RS[2]	RS[1]	RS[0]	DT[2]	DT[1]	DT[0]
Default Value	1	0	1	1	1	0	0	0

Range limits (max/min): 100/34

Units: amp

Command support: All functionality

Note: Range cross-check – value must be greater than IOUT\_OC\_WARN\_LIMIT value.

### IOUT\_OC\_FAULT\_RESPONSE [0x47]

Command support:

- Response settings (bits RSP0:1) – only settings of 11, unit shuts down and responds according to the retry settings below, is supported.
- Retry settings (bits RS0:2) – only settings of 000 (unit does not attempt to restart on fault) and 111 unit continuously restarts (normal startup) while fault is present until commanded off, bias power is removed or another fault condition causes the unit to shutdown.
- Delay time setting (bits 0-2) – only DT0:2 = 0 (no delay) supported.

Default Settings: The default settings for the IOUT\_OC\_FAULT\_RESPONSE command are;

- The unit shuts down in response to an IOUT over current condition.
- The unit will continuously restart (normal startup) while the IOUT over current condition is present until it is commanded off, bias power is removed or another fault condition causes the unit to shutdown.
- The shutdown delay is set to 0 delay cycles.

### IOUT\_OC\_WARN\_LIMIT [0x4A]

Range limits (max/min): 90/25



## Detailed Description of Supported PMBus Commands

Units: amp

Command support: read/write support, functionality complete

Note: Range cross-check – value must be less than IOOUT\_OC\_FAULT\_LIMIT value.

### OT\_FAULT\_LIMIT [0x4F]

Range limits (max/min): 140/25

Units: degrees C.

Command support: All functionality

Note: Range cross-check – value must be greater than OT\_WARN\_LIMIT value.

### OT\_FAULT\_RESPONSE [0x50]

Command support:

- Response settings (bits RSP0:1) – only setting of 10, unit shuts down and responds according to the retry settings below.
- Retry settings (bits RS0:2) – only settings of 000 (unit does not attempt to restart on fault) and 111 unit continuously restarts (normal startup) while fault is present until commanded off, bias power is removed or another fault condition causes the unit to shutdown.
- Delay time setting (bits DT0:2) – only DT0:2 = 0 (no delay) supported.

Default Settings: The default settings for the OT\_FAULT\_RESPONSE command are;

- The unit shuts down in response to an over-temperature condition.
- The unit will continuously restart (normal startup) while the over-temperature condition is present until it is commanded off, bias power is removed or another fault condition causes the unit to shutdown.
- The shutdown delay is set to 0 delay cycles.

### OT\_WARN\_LIMIT [0x51]

Range limits (max/min): 125/25

Format	8 bit unsigned (bit field)							
Bit Position	7	6	5	4	3	2	1	0
Access	r	r	r/w	r/w	r/w	r	r	r
Function	RSP[1]	RSP[0]	RS[2]	RS[1]	RS[0]	DT[2]	DT[1]	DT[0]
Default Value	1	0	1	1	1	0	0	0

Units: degrees C.

Command support: All functionality

Note: Range cross-check – value must be less than OT\_FAULT\_LIMIT value.

### VIN\_OV\_FAULT\_LIMIT [0x55]

Range limits (max/min): 90/48

Units: volt

Command support: All functionality

### VIN\_OV\_FAULT\_RESPONSE [0x56]

Command support:

Response settings (bits RSP0:1) – only settings of 11 (The device's output is disabled while the fault is present.) is supported..

## Detailed Description of Supported PMBus Commands

- Retry settings (bits RS0:2) – only settings of 000 (unit does not attempt to restart on fault).
- Delay time setting (bits 0-2) – only DT0:2 = 0 (no delay) supported.

Default Settings: The default settings for the VIN\_OV\_FAULT\_RESPONSE command are;

- The unit shuts down in response to a VIN over voltage condition.
- The unit will continuously prepares to restart (normal startup) while the VIN over voltage condition is present until it is commanded off, bias power is removed, the VIN over voltage condition is removed, or another fault condition causes the unit to shutdown.
- The shutdown delay is set to 0 delay cycles.

### POWER\_GOOD\_ON [0x5E]

Range limits (max/min): 11.7/9.2

Units: volt

Command support: full support

Note: Range cross-check – value must be greater than POWER\_GOOD\_OFF value by 1.6V.

### POWER\_GOOD\_OFF [0x5F]

Range limits (max/min): 10.1/7.6

Units: volt

Format	8 bit unsigned (bit field)							
Bit Position	7	6	5	4	3	2	1	0
Access	r	r	r	r	r	r	r	r
Function	RSP[1]	RSP[0]	RS[2]	RS[1]	RS[0]	DT[2]	DT[1]	DT[0]
Default Value	1	1	0	0	0	0	0	0

Command support: full support

Note: Range cross-check – value must be less than POWER\_GOOD\_ON value by 1.6V.

### TON\_DELAY [0x60]

Range limits (max/min): 500/0

Units: milliseconds

Command support: full support

### TON\_RISE [0x61]

Range limits (max/min): 500/15

Units: milliseconds

Command support: full support

### STATUS\_WORD [0x79]

Command support: full implementation for supported functions (note: Fans, MFR\_SPECIFIC, Unknown not supported)

(1) Not supported

### STATUS\_VOUT [0x7A]

Command support: VOUT\_OV\_FAULT support, all bit reset supported

## Detailed Description of Supported PMBus Commands

(1) Not supported

### STATUS\_IOUT [0x7B]

Format	8 bit unsigned (bit field)							
Bit Position	15	14	13	12	11	10	9	8
Access	r	r	r	r	r	r	r	r
Function	VOUT	I/POUT	INPUT	MFR_SPEC <sup>1</sup>	#PWR_GOOD	FANS <sup>1</sup>	OTHER <sup>1</sup>	UN KNOWN <sup>1</sup>

Format	8 bit unsigned (bit field)							
Bit Position	7	6	5	4	3	2	1	0
Access	r	r	r	r	r	r	r	r
Function	BUSY <sup>1</sup>	OUTPUT_OFF	VOUT_OV_FAULT	IOUT_OC_FAULT	VIN_UV_FAULT	TEMP	CML	NONE OF ABOVE <sup>1</sup>

Command support: IOUT\_OC\_FAULT support, all bit reset supported

(1) Not supported

### STATUS\_TEMPERATURE [0x7D]

Command support: OT\_WARN, OT\_FAULT supported, all bit reset supported

(1) Not supported

Format	8 bit unsigned (bit field)							
Bit Position	7	6	5	4	3	2	1	0
Access	r/reset (1)	r/reset	r/reset	r/reset	r/reset	r/reset	r/reset	r/reset
Function	VOUT_OV_FAULT	VOUT_OV_WARN <sup>1</sup>	VOUT_UV_WARN <sup>1</sup>	VOUT_UV_FAULT <sup>1</sup>	VOUT_MAX_WARN <sup>1</sup>	TON_MAX_FAULT <sup>1</sup>	TOFF_MAX_WARN <sup>1</sup>	VOUT TRACKING ERROR <sup>1</sup>

### STATUS\_CML [0x7E]

Command support: PEC\_FAULT, INVALID\_DATA, INVALID\_CMD supported, all bit reset supported

(1) Not supported

Format	8 bit unsigned (bit field)							
Bit Position	7	6	5	4	3	2	1	0
Access	r/reset(1)	r/reset	r/reset	r/reset	r/reset	r/reset	r/reset	r/reset
Function	IOUT_OC_FAULT	IOUT_OC_LV_FAULT <sup>1</sup>	IOUT_OC_WARN	IOUT_UC_FAULT <sup>1</sup>	Current Share Fault <sup>1</sup>	In Power Limiting Mode <sup>1</sup>	POUT_OP_FAULT <sup>1</sup>	POUT_OP_WARN <sup>1</sup>

### READ\_VIN [0x88]

Command support: full support

Format	8 bit unsigned (bit field)							
Bit Position	7	6	5	4	3	2	1	0
Access	r/reset(1)	r/reset	r/reset	r/reset	r/reset	r/reset	r/reset	r/reset
Function	OT_FAULT	OT_WARN	UT_WARN <sup>1</sup>	UT_FAULT <sup>1</sup>	reserved	reserved	reserved	reserved

### READ\_VOUT [0x8B]

Command support: full support

## Detailed Description of Supported PMBus Commands

### READ\_IOUT [0x8C]

Format	8 bit unsigned (bit field)							
Bit Position	7	6	5	4	3	2	1	0
Access	r/ reset(1)	r/ reset	r/ reset	r/ reset	r/ reset	r/ reset	r/ reset	r/ reset
Function	INVALID CMD	INVALID DATA	PEC FAILED	MEMORY FAULT <sup>1</sup>	PROC FAULT <sup>1</sup>	reserved	COM FAULT (other) <sup>1</sup>	Memory/ Logic fault (other) <sup>1</sup>

Command support: full support

### READ\_TEMPERATURE\_1 [0x8D]

Command support: full support

### PMBUS\_REVISION [0x98]

Command support: full support

\*See Table below:

### MFR\_DEVICE\_TYPE [0xD0]

Command support: partial support in place (Mod Name)

1. Present module designations (Non-isolated units will have a OXXXXX format)

- QBDS108A0B41xxx: [6 bits TBD]

### MFR\_VOUT\_READ\_CAL\_GAIN [0xD1]

Format	8 bit unsigned (bit field)							
Bit Position	7	6	5	4	3	2	1	0
Access	r	r	r	r	r	r	r	r
Function	Part I Revision			Part II Revision				
Default Value	0	1	0	reserved	0	0	1	0

Factory default: 0x2000

Range limits (max/min): 0x2666/0x1999

Units: N/A

PMBus Revision Data Byte Contents				
Bits [7:5]	Part I Revision	Bit [4]	Bits [3:0]	Part II Revision
000	1.0	Not used	0000	1.0
001	1.1	Not used	0001	1.1
010	1.2	Not used	0010	1.2

## Detailed Description of Supported PMBus Commands

Command support: support for VOUT gain calibration (factor in flash), lockout per MFR\_DEVICE\_TYPE

Format	Unsigned Binary															
Bit Pos.	7	6	5	4	3	2	1	0	7	6	5	4	3	2	1	0
Access	r/w	r/w	r/w	r/w	r/w	r	r	r	r/w	r/w	r/w	r/w	r/w	r/w	r/w	r/w
Function	Reserved								Module Name						WPE	Res
Default	0	0	0	0	0	0	0	0	1	0	1	0	1	0	1	0

Byte	Bit	Description	Value	Meaning
High Byte	7:0	Reserved		
Low Byte	7:2	Module Name <sup>1</sup>	1xxxxx	Module Name
	1	WPE	0	Write Protect Enable not active.
			1	Write Protect Enable active.
	0	Reserved	0	Reserved

### MFR\_VOUT\_READ\_CAL\_OFFSET [0xD2]

Range limits (max/min): exp must = -12

Units: N/A

Data format: VOUT linear except with a two's complement (signed) mantissa

Command support: support for VOUT offset calibration (factor in flash), lockout per MFR\_DEVICE\_TYPE

### MFR\_VIN\_READ\_CAL\_GAIN [0xD3]

Factory default: 0x2000

Range limits (max/min): 0x2666/0x1999

Command support: support for VIN gain calibration (factor in flash), lockout per MFR\_DEVICE\_TYPE

### MFR\_VIN\_READ\_CAL\_OFFSET [0xD4]

Data format: VIN linear format

Range limits (max/min): exp must = -3

Units: N/A

Command support: support for VIN offset calibration (factor in flash), lockout per MFR\_DEVICE\_TYPE

### MFR\_IOUT\_CAL\_GAIN [0xD6]

Range limits (max/min): 0x2666/0x1999

Units: N/A

Command support: support for IOUT gain calibration, lockout per MFR\_DEVICE\_TYPE

### MFR\_IOUT\_CAL\_OFFSET [0xD7]

Range limits (max/min): exp must = -3

Units: N/A

Command support: support for IOUT offset calibration, lockout per MFR\_DEVICE\_TYPE

### MFR\_FW\_REV [0xDB]

Range limits (max/min): 9999/0000

Units: N/A

Command support: full read support

Format: 4 hex characters: Major revision, Minor revision, Build high, Build low (0xMj.Mn.Bh.Bi)

## Detailed Description of Supported PMBus Commands

Example: 0x1218 indicates firmware revision 1.2.18.

### MFR\_ARA\_CONFIG [0xE0]

Command support: Full support.

### MFR\_PGOOD\_POLARITY [0xE2]

Command support: full support (bit 0) as follows:

Bit 0: 0 = Negative PGOOD logic (module PGOOD asserted when pin is LO, PGOOD de-asserted when pin is HI)

1 = Positive PGOOD logic (module PGOOD de-asserted when pin is LO, PGOOD asserted when pin is HI)

### MFR\_MODULE\_DATE\_LOC\_SN [0xF0]

Command support: read/write support for 12 byte block, lockout per MFR\_DEVICE\_TYPE

## PMBus Command Quick Reference Table

Command	MFR_ARA_CONFIG							
Format	8 bit unsigned (bit field)							
Bit Position	7	6	5	4	3	2	1	0
Access	r	r	r	r/w	r/w	r/w	r/w	r/w
Function	Reserved			ARA	Reserved			
Default Value	0	0	0	0	0	0	0	0

Bit	Description	Value	Meaning
7:5	Reserved	000	Reserved
4	ARA	0	ARA not functional, module remains at resistor programmed address when SMBLAERT is asserted
		1	ARA functional, module responds to ARA only, when SMBLAERT is asserted
3:0	Reserved		Reserved

Some Write commands are ignored until Write Protection is disabled using the MFR\_DEVICE\_TYPE (0xD0) command. These are identified by “lockout per MFR\_DEVICE\_TYPE” In the preceding detailed command descriptions.

## Mechanical Outline for QBDS108A0B41-PHZ (Base plate) Through-hole Module

Dimensions are in millimeters and [inches].

Command	MFR_PGOOD_POLARITY							
Format	8 bit unsigned (bit field)							
Bit Position	7	6	5	4	3	2	1	0
Access	r	r	r	r	r	r	r	r/w
Function	Reserved							logic
Default Value	0	0	0	0	0	0	0	0

Tolerances: x.x mm ± 0.5 mm [x.xx in. ± 0.02 in.] (Unless otherwise indicated)

x.xx mm ± 0.25 mm [x.xxx in ± 0.010 in.]

## Detailed Description of Supported PMBus Commands

PMBUS CMD	CMD CODE	DATA BYTES	DATA FORMAT	DATA UNITS	TRANSFER TYPE*	DEFAULT VALUE
OPERATION	0x01	1	Bit field	N/A	R/W byte	0x88
ON_OFF_CONFIG	0x02	1	Bit field	N/A	R/W byte	0x1D (Neg Logic) 0x1F (Pos Logic)
CLEAR_FAULTS	0x03	0	N/A	N/A	Send byte	none
STORE_DEFAULT_ALL	0x11	0	N/A	N/A	Send byte	none
RESTORE_DEFAULT_ALL	0x12	0	N/A	N/A	Send byte	none
VOUT_MODE	0x20	1	mode + exp	N/A	Read byte	0x14
VOUT_COMMAND	0x21	2	VOUT linear	Volts	R/W word	12V (Std code)
VOUT_CAL_OFFSET	0x23	2	VOUT linear	Volts	R/W word	MS
VOUT_MARGIN_HIGH	0x25	2	VOUT linear	Volts	R/W word	12.000V
VOUT_MARGIN_LOW	0x26	2	VOUT linear	Volts	R/W word	11.400V
VOUT_DROOP	0x28	2	linear	mV/A	R/W word	0 (without -P) 6.5 (with -P)
VIN_ON	0x35	2	linear	V	R/W word	47 V
VIN_OFF	0x36	2	linear	V	R/W word	43 V
VOUT_OV_FAULT_LIMIT	0x40	2	VOUT linear	V	R/W word	15V
VOUT_OV_FAULT_RESPONSE	0x41	1	Bit field	N/A	R/W byte	0xB8
IOUT_OC_FAULT_LIMIT	0x46	2	linear	Amps	R/W word	125A
IOUT_OC_FAULT_RESPONSE	0x47	1	Bit field	N/A	R/W byte	0xF8
IOUT_OC_WARN_LIMIT	0x4A	2	linear	Amps	R/W word	120A
OT_FAULT_LIMIT	0x4F	2	linear	Deg. C	R/W word	130C
OT_FAULT_RESPONSE	0x50	1	Bit field	N/A	R/W byte	0xB8
OT_WARN_LIMIT	0x51	2	linear	Deg. C	R/W word	116C
VIN_OV_FAULT_LIMIT	0x55	2	linear	V	R/W word	62V
VIN_OV_FAULT_RESPONSE	0x56	1	Bit field	N/A	R/W byte	0xC0
POWER_GOOD_ON	0x5E	2	VOUT linear	V	R/W word	TBD V
POWER_GOOD_OFF	0x5F	2	VOUT linear	V	R/W word	TBD V
TON_DELAY	0x60	2	linear	msec	R/W word	0ms
TON_RISE	0x61	2	linear	msec	R/W word	15ms (without -P) 15ms (with -P)
STATUS_WORD	0x79	2	Bit field	N/A	Read word	N/A
STATUS_VOUT	0x7A	1	Bit field	N/A	Read byte	N/A
STATUS_IOUT	0x7B	1	Bit field	N/A	Read byte	N/A
STATUS_INPUT	0x7C	1	Bit field	N/A	Read byte	N/A
STATUS_TEMPERATURE	0x7D	1	Bit field	N/A	Read byte	N/A
STATUS_CML	0x7E	1	Bit field	N/A	Read byte	N/A
READ_VIN	0x88	2	linear	v	Read word	N/A
READ_VOUT	0x8B	2	VOUT linear	v	Read word	N/A
READ_IOUT	0x8C	2	linear	Amps	Read word	N/A
READ_TEMP1	0x8D	2	linear	Deg. C	Read word	N/A
PMBUS_REVISION	0x98	1	Bit Field	n/a	Read byte	1.2
MFR_DEVICE_TYPE	0xD0	2	Custom	N/A	R/W word	0x00AA
MFR_VOUT_READ_CAL_GAIN	0xD1	2	16 bit unsigned	N/A	R/W word	0x2000
MFR_VOUT_READ_CAL_OFFSET	0xD2	2	mod VOUT linear	N/A	R/W word	MS
MFR_VIN_READ_CAL_GAIN	0xD3	2	16 bit unsigned	N/A	R/W word	MS
MFR_VIN_READ_CAL_OFFSET	0xD4	2	linear	N/A	R/W word	MS
MFR_IOUT_CAL_GAIN	0xD6	2	16 bit unsigned	N/A	R/W word	MS
MFR_IOUT_CAL_OFFSET	0xD7	2	linear	N/A	R/W word	MS
MFR_FW_REV	0xDB	2	16 bit unsigned	N/A	Read byte	0x1101
MFR_ARA_CONFIG	0xE0	1	Bit field	N/A	R/W byte	0x00
MFR_PGOOD_POLARITY	0xE2	1	Bit field	N/A	R/W byte	0x00
MFR_MOD_DATE_LOC_SN	0xF0	12	8 bit char	N/A	R/W block	YYLLWW123456

# Mechanical Specifications

TOP VIEW

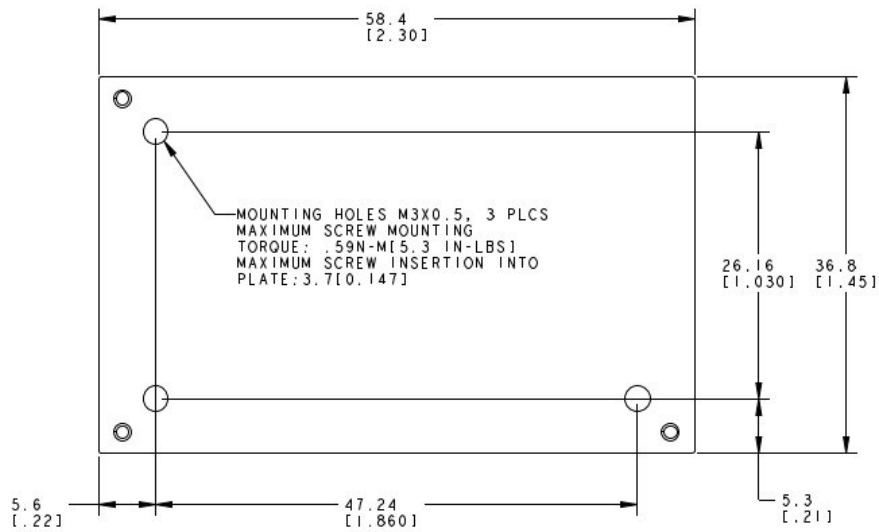

SIDE VIEW

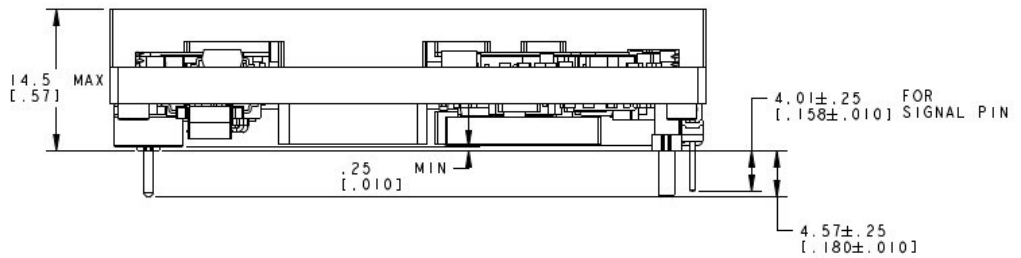

BOTTOM VIEW

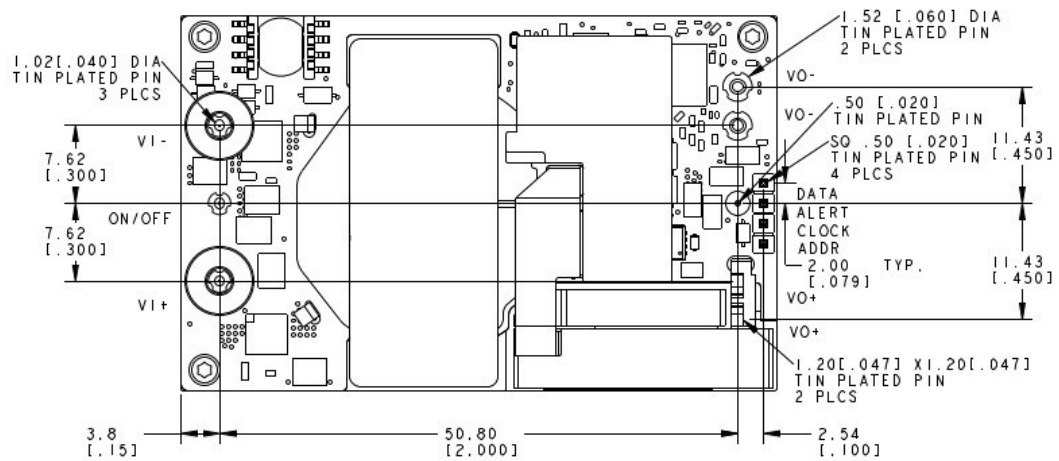

## Recommended Pad Layouts



## Mechanical Specifications (Continued)

Dimensions are in millimeters and (inches).

Tolerances: x.x mm ± 0.5 mm [x.xx in. ± 0.02 in.] (unless otherwise indicated)

x.xx mm ± 0.25 mm [x.xxx in. ± 0.010 in.]

Pin Number	Pin Name
1	VIN(+)
2	ON/OFF
3	VIN(-)
4	VOUT(-)
5	VOUT(-)
6	VOUT(+)
7	VOUT(+)
8	Data
9	Alert
10	Clock
11	AddrT
12	PGOOD

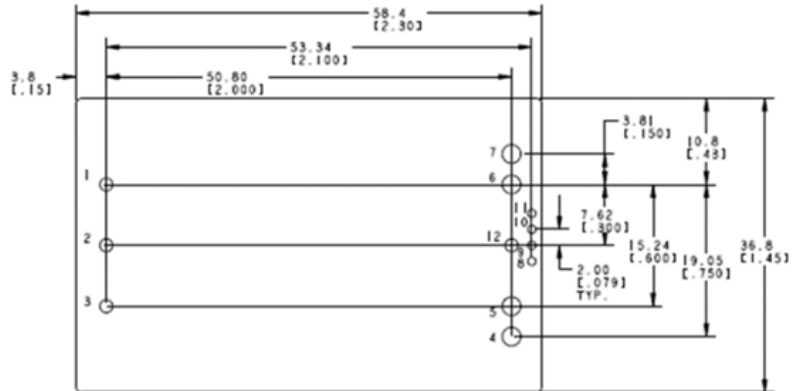

TOP VIEW

Hole and Pad diameter recommendations:

## Packaging Details

Pin Number	Hole Dia mm [in]	Pad Dia mm [in]
1, 2, 3	1.6 [0.63]	2.1 [0.83]
8,9,10,11,12	1.0 [0.39]	1.5 [0.59]
4,5,6,7	2.3 [0.91]	3.3 [1.30]

All versions of the QBDS108A0B41 are supplied as standard in the plastic trays shown in Figure 27.

## Tray Specification

Each tray contains a total of 12 power modules. The trays are self-

Material	PET (1mm)
Max surface resistivity	10 <sup>9</sup> -10 <sup>11</sup> W/PET
Color	Clear
Capacity	12 power modules
Min order quantity	24 pcs (1 box of 2 full trays + 1 empty top tray)

stacking and each shipping box for the QBDS108A0B41 module contains 2 full trays plus one empty hold-down tray giving a total number of 24 power modules.

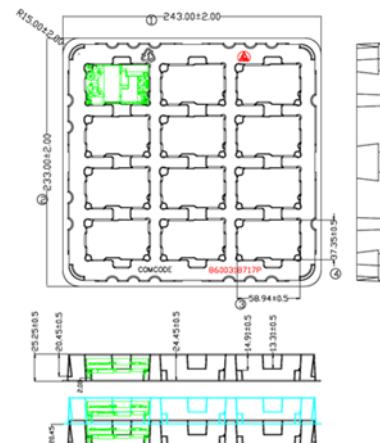

Base Module Figure

QBDS108A0B41 Packaging Tray

Plate Tray 27.

## Mechanical Specifications (Continued)

### Ordering Information

Please contact your GE Sales Representative for pricing, availability and optional features.

**Table 1. Device Codes.**

Product Codes	Input Voltage	Output Voltage	Output Current	Efficiency	Connector Type	MSL Ra-ting	Comcodes
QBDS108A0B41-PHZ	54V (48-60Vdc)	12V	108.3A	97.5%	Through hole	2a	1600306151A
QBDS108A0B6413-PHZ	54V (48-60Vdc)	12V	108.3A	97.5%	Through hole	2a	1600483294A

**Table 2. Device Options.**

Characteristic	Character and Position										Definition	
Form Factor	Q											Q = Quarter Brick
Family Designator		BD										BD = BARRACUDA Digital Series with PMBus Interface
Input Voltage			S									S = Special input voltage 45V - 57V
Output Power				108A0								125A = 125A Rated Output Current
Output Voltage					B							B = 12V nominal
Pin Length												Omit = Default Pin Length shown in Mechanical Outline (4.70 mm)
						8						8 = Pin Length: 2.79 mm ± 0.25mm, (0.110 in. ± 0.010 in.)
						6						6 = Pin Length: 3.68 mm ± 0.25mm, (0.145 in. ± 0.010 in.)
Action following Protective Shutdown									4			Omit = Latching Mode 4 = Auto-restart following shutdown (Overcurrent/Overvoltage)
On/off Logic										1		Omit = Positive Logic 1 = Negative Logic
											3	3 = Power Good Function
											-	
Load share											P	P = Forced Droop Output for use in parallel applications
Heat Plate											H	H = Heat plate, for use with a heat sink or cold wall
RoHS											Z	Z = RoHS Compliant

## QBDS108A0B Change History (excludes grammar & clarifications)

Revision	Date	Description of the change
1.8	06/14/2022	Updated ROHS
1.9	11/23/2023	Updated as per OmniOn template
1.10	2/1/2024	PG Option added

**OmniOn Power Inc.**

601 Shiloh Rd.  
Plano, TX USA

[omnionpower.com](http://omnionpower.com)

We reserve the right to make technical changes or modify the contents of this document without prior notice. OmniOn Power does not accept any responsibility for errors or lack of information in this document and makes no warranty with respect to and assumes no liability as a result of any use of information in this document.

We reserve all rights in this document and in the subject matter and illustrations contained therein. Any reproduction, disclosure to third parties or utilization of its contents – in whole or in parts – is forbidden without prior written consent of OmniOn Power. This document does not convey license to any patent or any intellectual property right. Copyright© 2023 OmniOn Power Inc. All rights reserved.