

QBDS095A10R6: Barracuda* DC-DC Converter

45 to 56V_{DC} input; [8.4, 11.2]V_{DC} output; 1000W output power

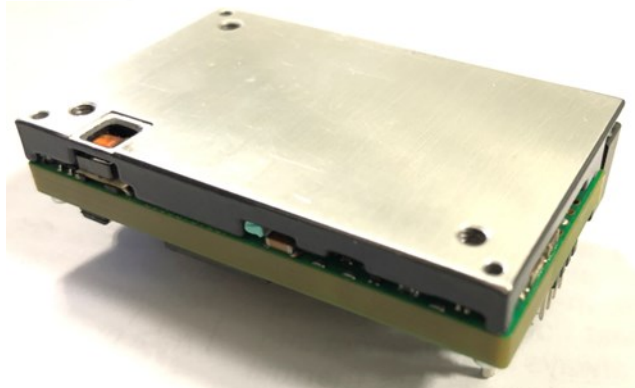

RoHS Compliant

The QBDS095A10R6 Barracuda™ series of dc-dc converters is a new generation of unregulated DC/DC power modules designed to support [8.4, 11.2]Vdc intermediate bus applications. The QBDS095A10R6 series operate from an input voltage range of 45 to 56Vdc and provide up to 1000W output power in an industry-standard, modified DOSA digital quarter brick. The converter incorporates digital control, synchronous rectification technology, unregulated control topology, and innovative packaging techniques to achieve minimum efficiency exceeding 96.5% at 700w output power. Standard features include a heat plate to attach external heat sinks or contact a cold wall, on/off control, output overcurrent and over voltage protection, over temperature protection, input under and over voltage lockout and PMBus interface. The output is fully isolated from the input, allowing versatile polarity configurations and grounding connections.

Application

- Distributed power architectures
- Intermediate bus voltage applications
- Networking equipment
- Servers and storage applications
- Supercomputers
- Automatic Test Equipment

Features

- Compliant to RoHS Directive 2011/65/EU and amended Directive (EU) 2015/863
- Compliant to REACH Directive (EC) No 1907/2006
- High and flat efficiency with peak efficiency 97%
- Input voltage range: 45-56Vdc
- Delivers up to 1000W output power
- Low output ripple and noise
- Industry standard, modified-DOSA Digital Quarter Brick: 58.4mm x 36.8mm x 14.5 mm(2.30in x 1.45in x 0.57in)
- Constant switching frequency
- Remote On/Off control
- Output over current protection
- Digital interface with PMBus™ Rev.1.2 compliance
- Black box
- Over temperature protection
- Pre-bias startup
- Wide operating temperature range: -5°C to 85°C, continuous
- ANSI/UL# 62368-1 and CAN/CSA† C22.2 No. 62368-1 Recognized, DIN VDE‡ 0868-1/A11:2017 (EN62368-1:2014/A11:2017)
- ISO** 9001 and ISO 14001 certified manufacturing facilities
- Base plate (-H=option code, always required)
- Class II, Category 2, Isolated DC/DC Converter (IPC-9592B)

* UL is a registered trademark of Underwriters Laboratories, Inc.

† CSA is a registered trademark of Canadian Standards Association.

‡ VDE is a trademark of Verband Deutscher Elektrotechniker e.V.

** ISO is a registered trademark of the International Organization of Standards # The PMBus name and logo are registered trademarks of the System Management Interface Forum (SMIF)

QBDS095A10R6 Technical Specifications

Absolute Maximum Ratings

Stresses in excess of the absolute maximum ratings can cause permanent damage to the device. These are absolute stress ratings only, functional operation of the device is not implied at these or any other conditions in excess of those given in the operations sections of the data sheet. Exposure to absolute maximum ratings for extended periods can adversely affect the device reliability.

| Parameter | Symbol | Min | Max | Unit |
|---|--------------|------|------|----------|
| Input Voltage ¹ | | | | |
| Continuous | V_{IN} | -0.3 | 60 | V_{dc} |
| $V_{ON/OFF}$ to $V_{IN}(-)$ | $V_{ON/OFF}$ | - | 14.5 | V_{dc} |
| ADDR to $V_{out}(-)$ | | -0.5 | 3.8 | V |
| Operating Ambient Temperature | | | | |
| Long-Term Operating | T_A | -5 | 85 | °C |
| Short-Term Operating (96 hours/year) | T_A | -20 | 90 | °C |
| Storage Temperature | T_{stg} | -40 | 100 | °C |
| I/O Isolation Voltage ² (100% factory Hi-Pot tested) | - | - | 2250 | V_{dc} |

¹ Input over voltage protection will shutdown the output voltage when the input voltage exceeds threshold level.

² Base plate is considered floating.

Electrical Specifications

Unless otherwise indicated, specifications apply overall operating input voltage, resistive load, and temperature conditions.

| Parameter | Device | Symbol | Min | Typ | Max | Unit |
|---|--------|------------------|-----|-------|-----|----------|
| Operating Input Voltage | | V_{IN} | 45 | 50/54 | 56 | V_{dc} |
| Maximum Input Current ($V_{IN}=45V$, $I_O=I_{O,max}$) | | $I_{IN,max}$ | - | - | 26 | A_{dc} |
| Input No Load Current ($V_{IN} = V_{IN,nom}$, $I_O = 0A$, module enabled) | All | $I_{IN,No load}$ | | 160 | | mA |

QBDS095A10R6 Technical Specifications (continued)

| Parameter | Device | Symbol | Min | Typ | Max | Unit |
|--|-----------|--------------------|-----|-----|------|---------------|
| Input Stand-by Current ($V_{IN} = V_{IN,nom}$, module disabled) | All | $I_{IN, stand-by}$ | | | 30 | mA |
| Input Capacitance | All | | 140 | - | 1000 | μF |
| Output Capacitance per Unit (Typically 50% ceramic, 50% Oscon or POSCAP For single unit configuration, Enable can be asserted before or after V_{in} rises above the Turn-On Voltage) | All | | 0 | - | 6500 | μF |
| Output Capacitance per Unit (Typically 50% ceramic, 50% Oscon or POSCAP For parallel unit configuration, Enables must be asserted simultaneously at least 25ms after V_{in} rises above the Turn-On | All | | 0 | - | 6500 | μF |
| Inrush Current (Inrush Current is defined as the peak current drawn by the unit when unit is enabled after V_{in} is present. I_{in} is defined as the steady-state operating current when unit is operating at $V_{in Max}$ and $P_{out Max}$. While V_{out} is rising, P_{out} is $\leq 25\%$ of $P_{out Max}$ with a resistive load) | All | | - | - | 50 | % of I_{in} |
| Input Terminal Ripple Current (Measured at module input pin with maximum specified input capacitance and $< 500\mu H$ inductance between voltage source and input capacitance) | All | | - | - | 1.25 | mA_{rms}/W |
| DC Output Band (Includes DC Output Set-Point, all specified line & load conditions, temperature, and aging) | -P Option | V_o | 8.4 | - | 11.2 | V_{dc} |
| Output Ripple and Noise ($C_{out} = 1\mu F/W$ minimum, approximately 50% ceramic, 50% Oscon or POSCAP. Measured at output pins, bandwidth = 20MHz) | All | | - | - | 150 | mV_{pk-pk} |
| Output Power | All | P_o | 0 | - | 1000 | W |

QBDS095A10R6 Technical Specifications (continued)

| Parameter | Device | Symbol | Min | Typ | Max | Unit |
|---|--------|-------------|------|-----|-----|-----------|
| Output Current (as unit is unregulated version, it depend on input voltage) | | | | | | |
| $V_{IN}=45V$ | All | I_o | 0 | — | 119 | A |
| $V_{IN}=50V$ | | | 0 | — | 105 | A |
| $V_{IN}=54V$ | | | 0 | — | 97 | A |
| $V_{IN}=56V$ | | | 0 | — | 93 | A |
| VOUT_OC_FAULT_LIMIT (Adjustable via PMBus) (as unit is unregulated version, it depend on input voltage) | | | | | | |
| $V_{IN}=45V$ | All | $I_{o,lim}$ | — | 135 | — | A_{dc} |
| $V_{IN}=50V$ | | | — | 123 | — | A_{dc} |
| $V_{IN}=54V$ | | | — | 115 | — | A_{dc} |
| $V_{IN}=56V$ | | | — | 110 | — | A_{dc} |
| Efficiency | | | | | | |
| $P_{out} = 700W$, V_{in} = worst-case condition, $T_{baseplate} = 100C$, airflow = 200 LFM | All | η | 96.5 | | | % |
| $P_{out} = 1000W$ | All | η | 95.5 | | | % |
| Switching Frequency (Primary FETs) | | f_{sw} | | 160 | | kHz |
| Dynamic Load Response Load step = 25% of P_{out} Max at 1A/ μ S, 4 μ F/W of external capacitance, measured at output pins. This load step can occur anywhere between, but must stay within, no-load and P_{out} Max | | | | | | |
| Peak Deviation | All | V_{pk} | — | 350 | — | mV_{pk} |

Isolation Specifications

| Parameter | Symbol | Min | Typ | Max | Unit |
|-----------------------|-----------|-----|-----|-----|------------|
| Isolation Capacitance | C_{iso} | — | TBD | — | nF |
| Isolation Resistance | R_{iso} | 10 | — | — | M Ω |

QBDS095A10R6 Technical Specifications (continued)

General Specifications

| Parameter | Device | Symbol | Typ | Unit |
|--|--------|--------|--------------|---------|
| Calculated Reliability Based upon Telcordia SR-332 Issue 3: Method I, Case 3, (IO=80%I _{O,max} , Tc=40°C, Airflow = 200 LFM), 90% confidence | All | MTBF | TBD | Hours |
| Weight – with Base plate | | | 90.2g(3.2oz) | g (oz.) |

Feature Specifications

Unless otherwise indicated, specifications apply overall operating input voltage, resistive load, and temperature conditions. See Feature Descriptions for additional information.

| Parameter | Device | Symbol | Min | Typ | Max | Unit |
|---|-----------|---|-----|-----|------|-----------------|
| Remote On/Off Signal Interface (V _{IN} =V _{IN,min} to V _{IN,max} , Signal referenced to V _{IN-} terminal) Negative Logic (“1” device code suffix): Logic Low = module On; Logic High = module Off Positive Logic (no device code suffix): Logic Low = module Off; Logic High = module On Logic Low (pull down to V _{IN(-)} externally) | | | | | | |
| Voltage | All | V _{on/off} | – | – | 0.8 | V _{dc} |
| Sink current | All | I _{on/off} | – | – | 500 | µA |
| Logic High (default; pulled up internally) | | | | | | |
| Internal pull-up voltage | All | V _{on/off} | 2.4 | – | – | V _{dc} |
| Optional external applied voltage | All | V _{on/off} | 2.4 | – | 14.5 | V _{dc} |
| Leakage current of external pull-down device (V _{on/off} = 2.4V) | All | I _{on/off} | – | – | 130 | µA |
| Turn-On Delay and Rise Times (I _O =I _{O,max} , Adjustable via PMBus) T _{delay} =Time until V _O = 10% of V _{O,set} from either application of V _{in} with Remote On/Off set to On (Enable with V _{in}); or operation of Remote On/Off from Off to On with V _{in} already applied for at least 30 milli-seconds (Enable with on/off). | -P option | T _{delay} , Enable with V _{in} | – | – | 30 | ms |
| | | T _{delay} , Enable with on/off | – | – | 5 | ms |

QBDS095A10R6 Technical Specifications (continued)

| Parameter | Device | Symbol | Min | Typ | Max | Unit |
|---|-----------|---------------|-----|-----|------|----------|
| T_{rise} =Time for V_O to rise from 10% to 90% of $V_{O,set}$, | All | T_{rise} | – | 15 | – | ms |
| Over shoot at turn on | | | | | 350 | mV |
| Under shoot at turn off | | | | | 350 | mV |
| Load Sharing Current Balance (All units' output power must share within 10% of each other when unit operating at the highest power level is operating at $P_{out Max}$) | -P option | I_{diff} | – | – | 10 | % |
| Overtemperature Protection (Adjustable via PMBus) | All | $T_{OTP,set}$ | – | – | 131 | °C |
| Input Undervoltage Lockout (Adjustable via PMBus) | | | | | | |
| Turn-on Threshold | | | – | – | 45 | V_{dc} |
| Turn-off Threshold | | | – | – | 42.5 | V_{dc} |
| Hysteresis | | | 2 | | | V_{dc} |
| Input Overvoltage Lockout (Adjustable via PMBus) | | | 61 | – | 65 | V_{dc} |

Digital Interface Specifications

Unless otherwise indicated, specifications apply overall operating input voltage, resistive load, and temperature conditions. See Feature Descriptions for additional information.

| Parameter | Conditions | Symbol | Min | Typ | Max | Unit |
|--|----------------|----------|-----|-----|-----|---------|
| PMBus Signal Interface Characteristics | | | | | | |
| Input High Voltage (CLK, DATA) | | V_{IH} | 2.1 | | 3.6 | V |
| Input Low Voltage (CLK, DATA) | | V_{IL} | | | 0.8 | V |
| Input high level current (CLK, DATA) | | I_{IH} | -10 | | 10 | μA |
| Input low level current (CLK, DATA) | | I_{IL} | -10 | | 10 | μA |
| Output Low Voltage (CLK, DATA, SMBALERT#) | | V_{OL} | | | 0.4 | V |
| Output Low internal sink current (CLK, DATA) | $V_{OL}=0.4V$ | I_{OL} | 4 | | | mA |
| Output Low internal sink current (SMBALERT#) | $V_{OL}=0.4V$ | I_{OL} | 2 | | | mA |
| Output high level internal leakage current (DATA, SMBALERT#) | $V_{OUT}=3.6V$ | I_{OH} | 0 | | 10 | μA |
| Pin capacitance | | C_O | | 0.7 | | pF |
| PMBus Operating frequency range (* 5-10 kHz to accommodate hosts not supporting | Slave Mode | FPMB | 5* | | 400 | kHz |

QBDS095A10R6 Technical Specifications (continued)

| Parameter | Conditions | Symbol | Min | Typ | Max | Unit |
|--|-------------------------|----------------|------|-------|---------|------|
| Measurement System Characteristics | | | | | | |
| Output current reading range | | $I_{OUT(RNG)}$ | 1.65 | | 145 | A |
| Output current reading blanking | | $I_{OUT(BNK)}$ | 0 | | 1.5875 | A |
| Output current reading resolution | | $I_{OUT(RES)}$ | | 146 | | mA |
| Output current reading accuracy | $40A < I_{out} < 145A$ | $I_{OUT(ACC)}$ | -5 | 0 | 5 | % |
| Output current reading accuracy (absolute difference between actual and reported values) | $1.65A < I_{out} < 40A$ | $I_{OUT(ACC)}$ | -3 | | 3 | A |
| V_{OUT} reading range | | $V_{OUT(RNG)}$ | 0 | | 15.9997 | V |
| V_{OUT} reading resolution | | $V_{OUT(RES)}$ | | 0.244 | | mV |
| V_{OUT} reading accuracy | | $V_{OUT(ACC)}$ | -2 | 0.6 | 2 | % |
| V_{IN} reading range | | $V_{IN(RNG)}$ | 0 | | 127.875 | V |
| V_{IN} reading resolution | | $V_{IN(RES)}$ | | 125 | | mV |
| V_{IN} reading accuracy | | $V_{IN(ACC)}$ | -4 | 0.8 | 4 | % |
| Temperature reading resolution | | $T_{(RES)}$ | | 0.25 | | °C |
| Temperature reading accuracy | | $T_{(ACC)}$ | -5 | | 5 | % |

QBDS095A10R6 Technical Specifications (continued)

Characteristic Curves, 1000w Output

The following figures provide typical characteristics for the QBDS095A10R61-PHZ (1000w) at 25°C. The figures are identical for either positive or negative Remote On/Off logic.

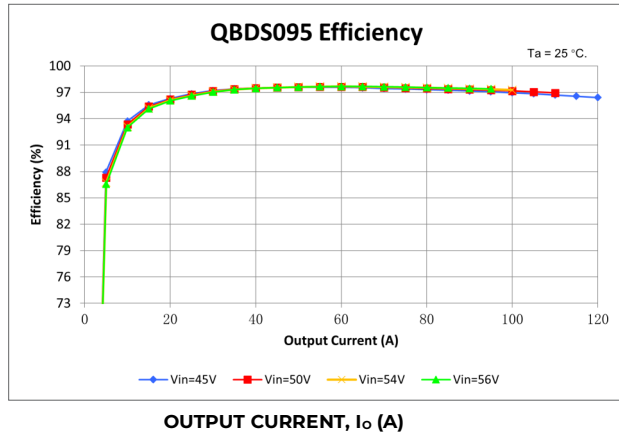

Figure 1. Converter Efficiency versus Output Current.

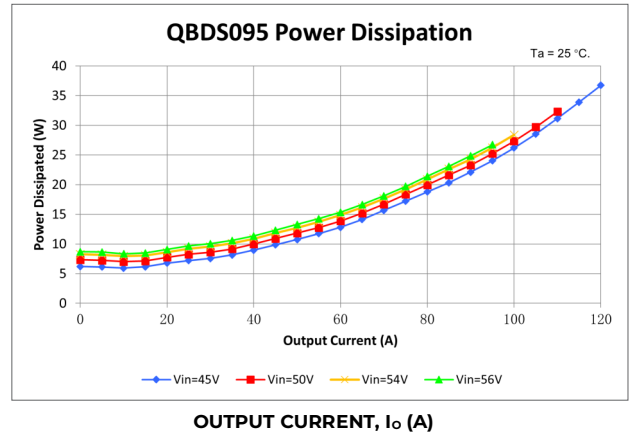

Figure 2. Derating Output Current versus Ambient Temperature and Airflow.

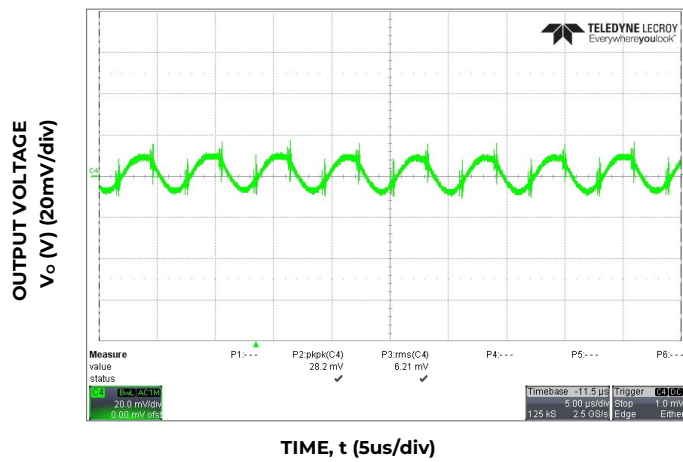

Figure 3. Typical output ripple and noise (C_o = 500µF Ceramic + 500µF PosCap Oscon, V_{in} = 56V, I_o = I_{o,max}).

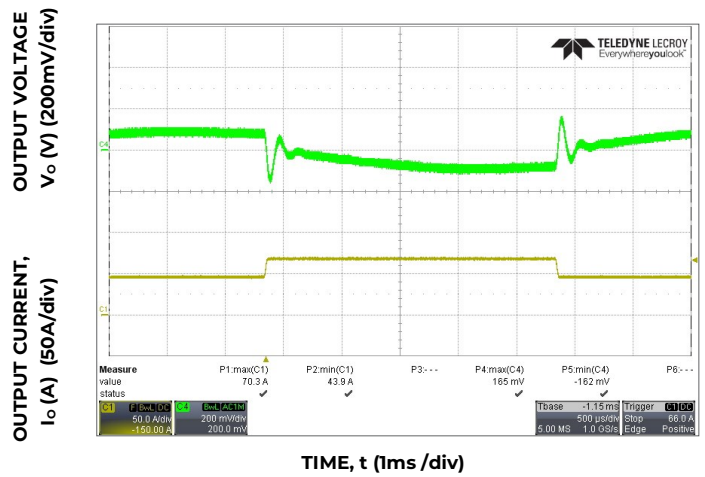

Figure 4. Dynamic Load Response, di_o/dt=1A/us; V_{in}=V_{in,nom}; T_A=25°C; Load Change from I_o = 50% to 75% of I_{o,max}; C_o =400µF Ceramic;

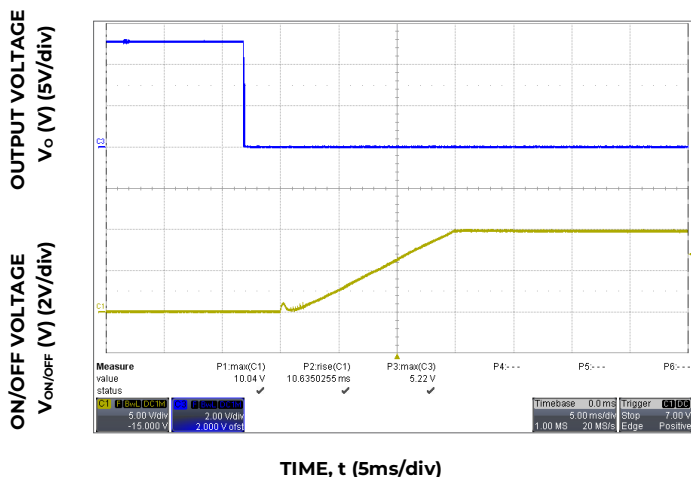

Figure 5. Typical Start-up Using On/Off Voltage (I_o = I_{o,max}).

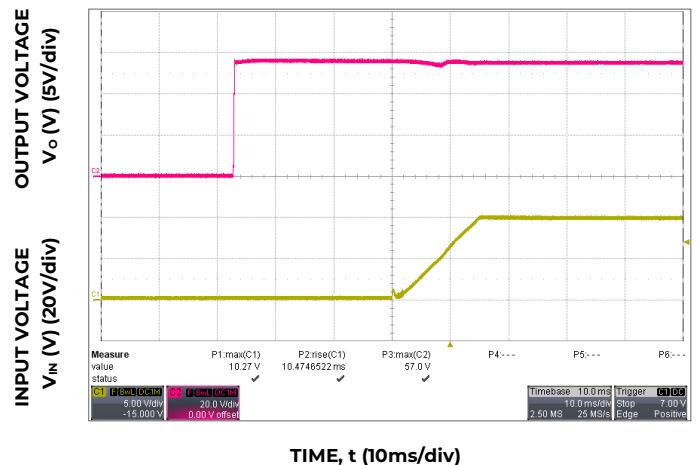

Figure 6. Typical Start-up Using Input Voltage (V_{in} = 56V, I_o = I_{o,max}).

QBDS095A10R6 Technical Specifications (continued)

Characteristic Curves, 1000w Output

The following figures provide typical characteristics for the QBDS095A10R61-PHZ (1000w) at 25°C. The figures are identical for either positive or negative Remote On/Off logic.

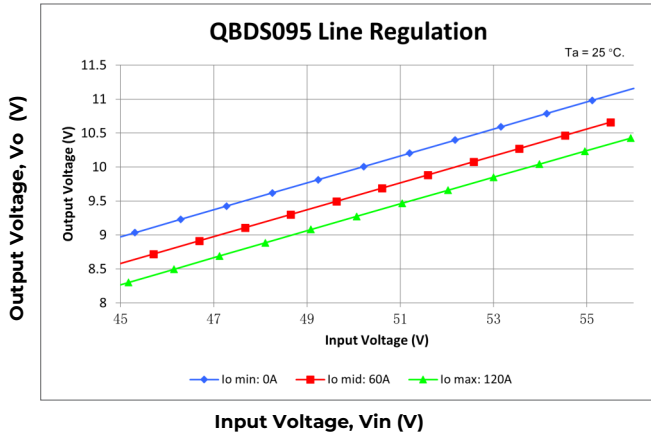

Figure 7. Typical Output Voltage Regulation vs Input Voltage

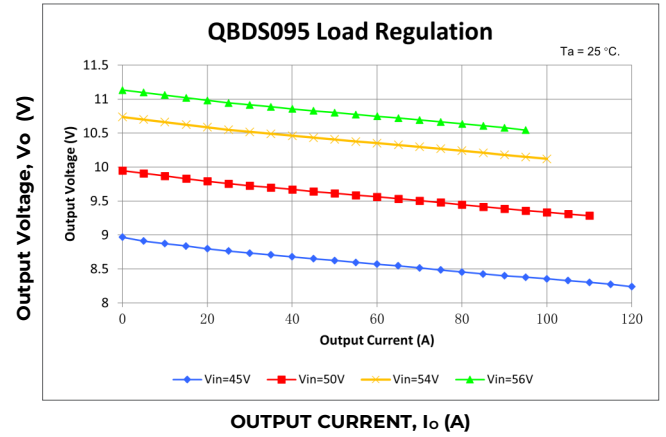

Figure 8. Typical Output Voltage Regulation vs Output Current

Test Configurations

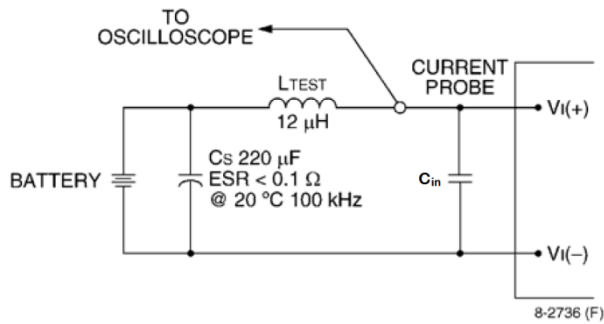

Figure 9. Input Reflected Ripple Current Test Setup.

Note: Measure input reflected-ripple current with a simulated source inductance (LTEST) of 12 μH. Capacitor CS offsets possible battery impedance. Measure current as shown above.

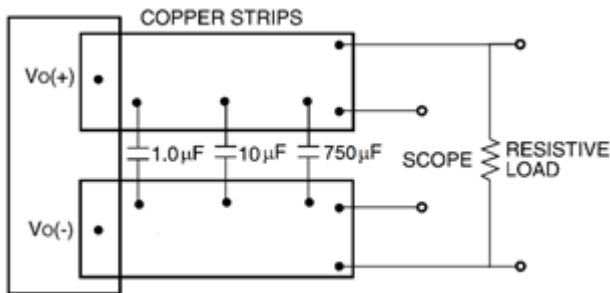

Figure 10. Output Ripple and Noise Test Setup.

Note: Use a 1.0 μF ceramic capacitor, a 10 μF aluminum or tantalum capacitor and a 750 polymer capacitor. Scope measurement should be made using

a BNC socket. Position the load between 51 mm and 76 mm (2 in. and 3 in.) from the module.

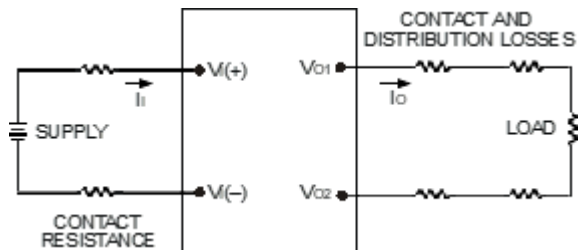

Figure 11. Output Voltage and Efficiency Test Setup.

Note: All measurements are taken at the module terminals. When socketing, place Kelvin connections at module terminals to avoid measurement errors due to socket contact resistance.

$$\eta = \left(\frac{[V_{O(+)} - V_{O(-)}]I_{O}}{[V_{I(+)} - V_{I(-)}]I_{I}} \right) \times 100 \%$$

Design Considerations

Input Source Impedance

The power module should be connected to a low ac impedance source. Highly inductive source impedance can affect the stability of the power module. For the test configuration in Figure 13, a 660μF electrolytic capacitor, Cin, (ESR<0.7W at 100kHz), mounted close to the power module helps ensure the stability of the unit.

QBDS095A10R6 Technical Specifications (continued)

Safety Considerations

For safety-agency approval of the system in which the power module is used, the power module must be installed in compliance with the spacing and separation requirements of the end-use safety agency standard, i.e., UL60950-1 2nd Ed., CSA C22.2 No. 60950-1 2nd Ed., and VDE0805-1 EN60950-1 2nd Ed.

If the input source is non-SELV (ELV or a hazardous voltage greater than 60 Vdc and less than or equal to 75Vdc), for the module's output to be considered as meeting the requirements for safety extra-low voltage (SELV), all of the following must be true:

The input source is to be provided with reinforced insulation from any other hazardous voltages, including the ac mains.

One VIN pin and one VOUT pin are to be grounded, or both the input and output pins are to be kept floating.

The input pins of the module are not operator accessible.

Another SELV reliability test is conducted on the whole system (combination of supply source and subject module), as required by the safety agencies, to verify that under a single fault, hazardous voltages do not appear at the module's output.

Note: Do not ground either of the input pins of the module without grounding one of the output pins. This may allow a non-SELV voltage to appear between the output pins and ground.

The power module has safety extra-low voltage (SELV) outputs when all inputs are SELV.

The input to these units is to be provided with a maximum 30A fast-acting (or time-delay) fuse in the ungrounded input lead.

Feature Descriptions

Overcurrent Protection

To provide protection in a fault output overload condition, the module is equipped with internal current-limiting circuitry and can endure current limiting continuously. If the overcurrent condition causes the output voltage to fall greater than 3.0V from $V_{o,set}$, the module will shut down and remain latched off. The overcurrent latch is reset by either cycling the input power or by toggling the on/off pin

for one second. If the output overload condition still exists when the module restarts, it will shut down again. This operation will continue indefinitely until the overcurrent condition is corrected.

A factory configured auto-restart option (with overcurrent and overvoltage auto-restart managed as a group) is also available. An auto-restart feature continually attempts to restore the operation until fault condition is cleared.

Remote ON/OFF

The module contains a standard on/off control circuit reference to the VIN(-) terminal. Two factory configured remote on/off logic options are available. Positive logic remote on/off turns the module on during a logic-high voltage on the ON/OFF pin, and off during a logic low. Negative logic remote on/off turns the module off during a logic high, and on during a logic low. Negative logic, device code suffix "1," is the factory-preferred configuration.

The On/Off circuit is powered from an internal bias supply, derived from the input voltage terminals. To turn the power module on and off, the user must supply a switch to control the voltage between the On/Off terminal and the VIN(-) terminal ($V_{on/off}$). The switch can be an open collector or equivalent (see Figure 16). The switch should maintain $<0.8V$ while sinking up to $200\mu A$. During a logic high when the switch is off, the maximum allowable leakage current at $V_{on/off} = 2.4V$ is $130\mu A$. If using an external voltage source, the maximum voltage $V_{on/off}$ on the pin is 14.5V with respect to the VIN(-) terminal.

If not using the remote on/off feature, perform one of the following to turn the unit on:

For negative logic, short ON/OFF pin to VIN(-).

For positive logic: leave ON/OFF pin open.

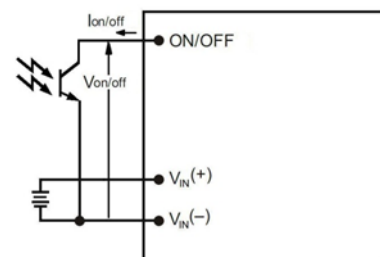

Figure 12. Remote On/Off Implementation.

QBDS095A10R6 Technical Specifications (continued)

Output Overvoltage Protection

The module contains circuitry to detect and respond to output overvoltage conditions. If the overvoltage condition causes the output voltage to rise above the limit in the Specifications Table, the module will shut down and remain latched off. The overvoltage latch is reset by either cycling the input power, or by toggling the on/off pin for one second. If the output overvoltage condition still exists when the module restarts, it will shut down again. This operation will continue indefinitely until the overvoltage condition is corrected.

A factory configured auto-restart option (with overcurrent and overvoltage auto-restart managed as a group) is also available. An auto-restart feature continually attempts to restore the operation until fault condition is cleared.

Overtemperature Protection

These modules feature an overtemperature protection circuit to safeguard against thermal damage. The circuit shuts down the module when the maximum device reference temperature is exceeded. The module will automatically restart once the reference temperature cools by ~25°C.

Input Under/Over voltage Lockout

At input voltages above or below the input under/over voltage lockout limits, module operation is disabled. The module will begin to operate when the input voltage level changes to within the under and overvoltage lockout limits. However recovery from input undervoltage may be delayed by 4 seconds, or 13 seconds if the module is hot.

Load Sharing

For higher power requirements, the QBDS095A10R61 - P module offers an optional feature for parallel operation (-P Option code). This feature provides a precise forced output voltage load regulation droop characteristic. The output set point and droop slope are factory calibrated to ensure optimum matching of multiple modules' load regulation characteristics. To implement load sharing, the following requirements should be followed:

The VOUT(+) and VOUT(-) pins of all parallel modules must be connected together. Balance the trace resistance for each module's path to the output power planes, to ensure best load sharing and operating temperature balance.

VIN must remain between 45Vdc and 56Vdc for droop sharing to be functional.

It is permissible to use a common Remote On/Off signal to start all modules in parallel. However if spurious shutdowns occur at startup due to very low impedance between module outputs, the modules should be started sequentially instead, waiting at least the Turn-On Delay Time + Rise Time before starting the next module.

These modules contain means to block reverse current flow upon start-up, when output voltage is present from other parallel modules, thus eliminating the requirement for external output ORing devices. Modules with the -P option may automatically increase the Turn On delay, Tdelay, as specified in the Feature Specifications Table, if output voltage is present on the output bus at startup.

When parallel modules startup into a pre-biased output, e.g. partially discharged output capacitance, the Trise is automatically increased, as specified in the Feature Specifications Table, to ensure graceful startup.

Ensure that the total load is <50% IO,MAX (for a single module) until all parallel modules have started. Full load may be applied after Max Tdelay + Trise.

If fault tolerance is desired in parallel applications, output ORing devices should be used to prevent a single module failure from collapsing the load bus.

Power Good, PG (option)

The QBDS095A10R module provides a Power Good (PG) option, which compares the module's output voltage to the module's POWER_GOOD_ON and POWER_GOOD_OFF values. These values are adjustable via PMBus. PG is asserted when the module's output voltage is above the POWER_GOOD_ON value, and PG is de-asserted if any condition such as overtemperature, overcurrent or loss of regulation occurs that would result in the output voltage going below the POWER_GOOD_OFF value.

The PG signal, provided on pin C2, is implemented with an open-drain node, pulled up via a 10kΩ resistor to 3.3V internally. For Positive Logic PG (default), the PG signal is HI, when PG is asserted, and LO, when the PG is de-asserted. For Negative Logic PG, the PG signal is LO, when PG is asserted, and HI, when the PG is de-asserted.

QBDS095A10R6 Technical Specifications (continued)

The PMBus command MFR_PGOOD_POLARITY is used to set the logic polarity of the signal.

If not using the Power Good feature, the pin may be left N/C.

Default code is with PG pin.

Please contact OmniOn representative for this option.

Thermal Considerations

The power modules operate in a variety of thermal environments and sufficient cooling should be provided to help ensure reliable operation. Thermal considerations include ambient temperature, airflow, module power dissipation, and the need for increased reliability. A reduction in the operating temperature of the module will result in an increase in reliability. Heat-dissipating components are mounted on the top side of the module. Heat is removed by conduction, convection and radiation to the surrounding environment. Proper cooling can be verified by measuring the thermal reference temperature (TH1).

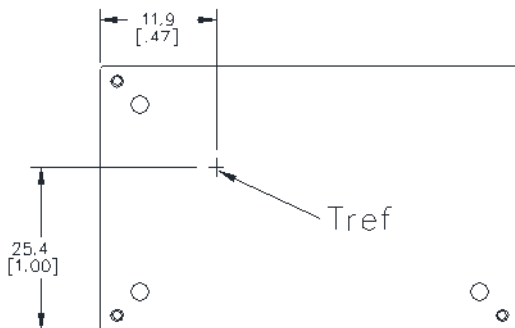

Figure 13. Location of the thermal reference temperature TH1 for base plate module.

Peak temperature occurs at the position indicated in Figure 13. For reliable operation, this temperature should not exceed TH1=100°C at any airflow condition. For extremely high reliability you can limit this temperature to a lower value. The output power of the module should not exceed the rated power for the module as listed in the Ordering Information table, or the derated power for the actual operating conditions as indicated in Figs. 15-18.

Heat Transfer via Convection

The thermal data presented here is based on physical measurements taken in a wind tunnel, using automated thermo-couple instrumentation to monitor key component temperatures: FETs, diodes, control ICs, magnetic cores, ceramic capacitors, opto-isolators, and module PWB conductors, while controlling the ambient airflow rate and temperature. For a given airflow and ambient temperature, the module output power is increased, until one (or more) of the components reaches its maximum derated operating temperature, as defined in IPC-9592B. This procedure is then repeated for a different airflow or ambient temperature until a family of module output derating curves is obtained. Please refer to the Application Note “Thermal Characterization Process For Open-Frame Board-Mounted Power Modules” for a detailed discussion of thermal aspects including maximum device temperatures.

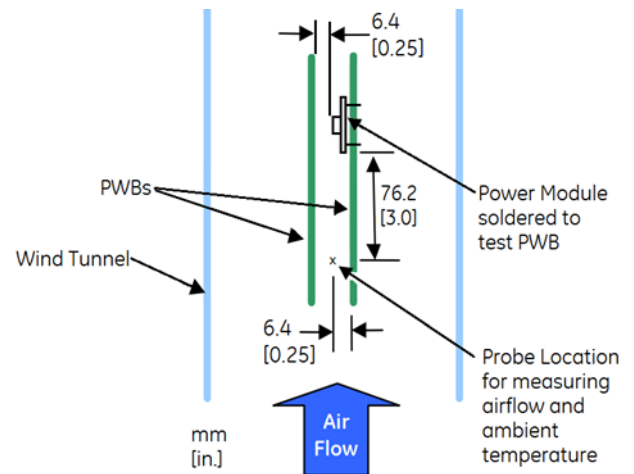

Figure 14. Thermal Test Setup

Increased airflow over the module enhances the heat transfer via convection. The thermal derating of figure 15-18 shows the maximum output current that can be delivered by each module in the indicated orientation without exceeding the maximum TH1 temperature versus local ambient temperature (TA) for several air flow conditions.

QBDS095A10R6 Technical Specifications (continued)

Thermal Considerations

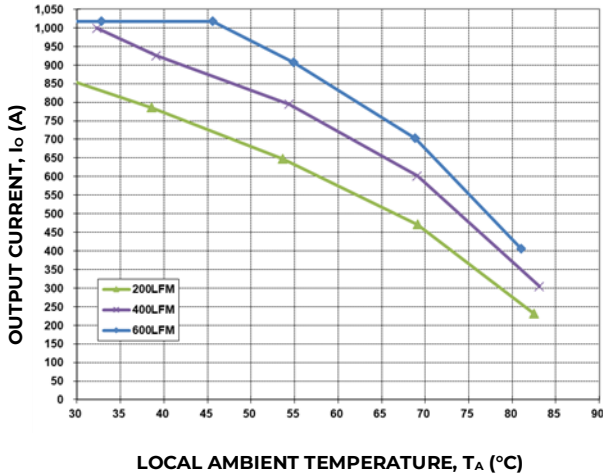

Figure 15. Output Current Derating for the Base Plate QBDS095A10R6-H; Airflow Direction for Vout to Vin(Worst) orientation; Vin = 50V.

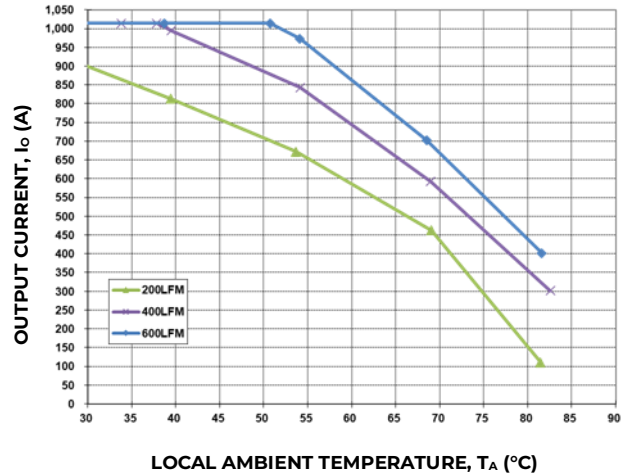

Figure 16. Output Current Derating for the Base Plate QBDS095A10R6-H; Airflow Direction for Vout to Vin(Worst) orientation; Vin = 54V.

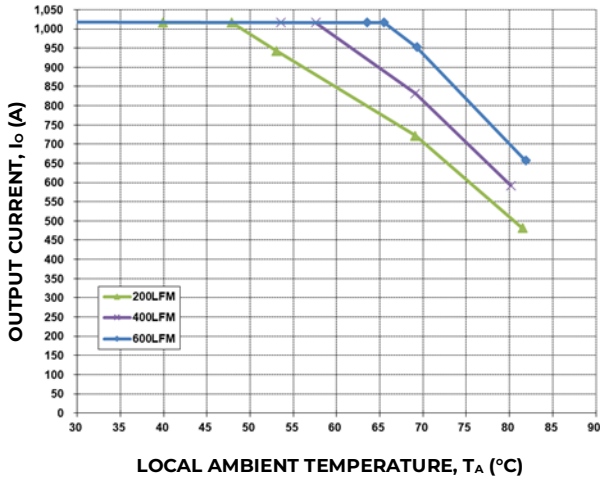

Figure 17. Output Current Derating for the Base plate QBDS095A10R6-H+0.6" Heat Sink; Airflow Direction for Vout to Vin (Worst) orientation; Vin = 50V.

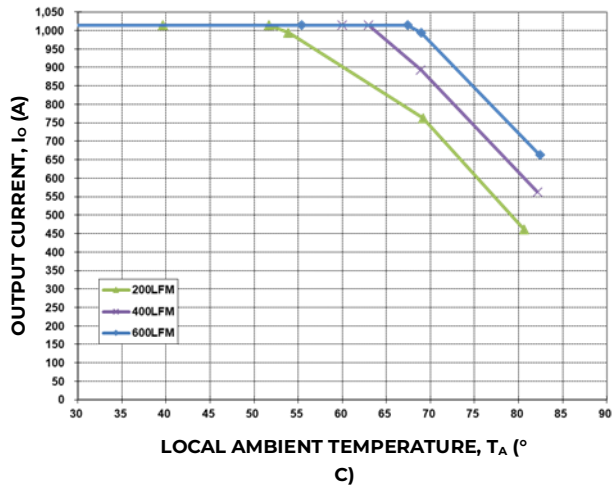

Figure 18. Output Current Derating for the Base plate QBDS095A10R6-H+0.6" Heat Sink; Airflow Direction for Vout to Vin (Worst) orientation; Vin = 54V.

QBDS095A10R6 Technical Specifications (continued)

Layout Considerations

The QBDS095A10R6 power module series are low profile in order to be used in fine pitch system card architectures. As such, component clearance between the bottom of the power module and the mounting board is limited. Avoid placing copper areas on the outer layer directly underneath the power module. Also avoid placing via interconnects underneath the power module.

For additional layout guide-lines, refer to FLT012A0Z Preliminary Data Sheet.

Through-Hole Lead-Free Soldering Information

The RoHS-compliant, Z version, through-hole products use the SAC (Sn/Ag/Cu) Pb-free solder and RoHS-compliant components. The module is designed to be processed through single or dual wave soldering machines. The pins have a RoHS-compliant, pure tin finish that is compatible with both Pb and Pb-free wave soldering processes. A maximum preheat rate of 3°C/s is suggested. The wave preheat process should be such that the temperature of the power module board is kept below 210°C. For Pb solder, the recommended pot temperature is 260°C, while the Pb-free solder pot is 270°C max.

Reflow Soldering

The RoHS-compliant through-hole products can be processed with the following pin-in-paste (paste-in-hole) Pb or Pb-free reflow process.

Max. sustain temperature:

245°C (J-STD-020C Table 4-2: Packaging Thickness \geq 2.5mm / Volume $>$ 2000mm³),

Peak temperature over 245°C is not suggested due to the potential reliability risk of components under continuous high-temperature.

Min. sustain duration above 217°C : 90 seconds

Min. sustain duration above 180°C : 150 seconds

Max. heat up rate: 3°C/sec

Max. cool down rate: 4°C C/sec

In compliance with JEDEC J-STD-020C spec for 2 times reflow requirement.

Pb-free Reflow Profile

BMP module will comply with JEDEC J-STD-020 Rev. D (Moisture/Reflow Sensitivity Classification for Non-hermetic Solid-State Surface Mount Devices) for both Pb-free solder profiles and MSL classification procedures.

BMP will comply with J-STD-020C specification for reflow up to 3 times. When removing a module, using localized hot air counts as one reflow, but using a solder pot instead to heat the pins does not count as a reflow.

The suggested Pb-free solder paste is Sn/Ag/Cu (SAC). The recommended linear reflow profile using Sn/Ag/Cu solder is shown in Figure 25.

MSL Rating

The QBDS095A10R6 modules have a MSL rating as indicated in the Device Codes table, last page of this document.

Storage and Handling

The recommended storage environment and handling procedures for moisture-sensitive surface mount packages is detailed in J-STD-033 Rev. A (Handling, Packing, Shipping and Use of Moisture/Reflow Sensitive Surface Mount Devices). Moisture barrier bags (MBB) with desiccant are required for MSL ratings of 2 or greater. These sealed packages should not be broken until time of use. Once the original package is broken, the floor life of the product at conditions of \leq 30°C and 60% relative humidity varies according to the MSL rating (see J-STD-060A). The shelf life for dry packed SMT packages will be a minimum of 12 months from the bag seal date, when stored at the following conditions: $<$ 40° C, $<$ 90% relative humidity.

Post Solder Cleaning and Drying Considerations

Post solder cleaning is usually the final circuit board assembly process prior to electrical board testing. The result of inadequate cleaning and drying can affect both the reliability of a power module and the testability of the finished circuit board assembly. For

QBDS095A10R6 Technical Specifications (continued)

guidance on appropriate soldering, cleaning and drying procedures, refer to OmniOn Board Mounted Power **Modules: Soldering and Cleaning Application Note (AN04-001)**.

If additional information is needed, please consult with your OmniOn Sales representative for more details

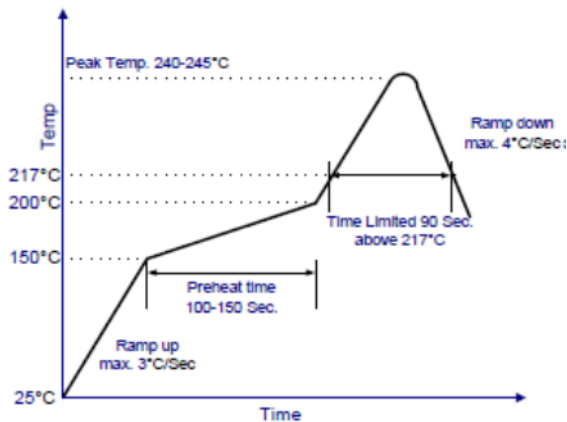

Figure 19. Recommended linear reflow profile using Sn/Ag/Cu solder.

Digital Feature Descriptions

PMBus Interface Capability

The QBDS095A10R6 series is equipped with a digital PMBus interface to allow the module to be configured, and communicate with system controllers. Detailed timing and electrical characteristics of the PMBus can be found in the PMB Power Management Protocol Specification, Part 1, revision 1.2, available at <http://pmbus.org>. The QBDS095A10R6 supports both the 100kHz and 400kHz bus timing requirements. The QBDS095A10R6 shall stretch the clock, as long as it does not exceed the maximum clock LO period of 35ms. The power module will check the Packet Error Checking scheme (PEC) byte, if provided by the PMBus master, and include a PEC byte in all responses to the master. However, the power module does not require a PEC byte from the PMBus master.

The power module supports a subset of the commands in the PMBus 1.2 specification. Most all of the controller parameters can be programmed using the PMBus and stored as defaults for later use. All commands that require data input or output use the linear format. The exponent of the data words is fixed

at a reasonable value for the command and altering the exponent is not supported. Direct format data input or output is not supported by the power module. The supported commands are described in greater detail below.

The power module contains non-volatile memory that is used to store configuration settings and scale factors. The settings programmed into the device are not automatically saved into this non-volatile memory though. The STORE_DEFAULT_ALL command must be used to commit the current settings to non-volatile memory as device defaults. The settings that are capable of being stored in non-volatile memory are noted in their detailed descriptions.

SMBALERT Interface Capability

The power module also supports the SMBALERT response protocol. The SMBALERT response protocol is a mechanism through which the power module can alert the PMBus master that it has an active status or alarm condition via pulling the SMBALERT pin to an active low. The master processes this condition, and simultaneously addresses all slaves on the PMBus through the Alert Response Address. Only the slave(s) that caused the alert (and that support the protocol) acknowledges this request. The master performs a modified receive byte operation to get the slave's address. At this point, the master can use the PMBus status commands to query the slave that caused the alert. Note: The power module can only respond to a single address at any given time. Therefore, the factory default state for the power module is to retain its resistor programmed address, when it is in an ALERT active condition, and not respond to the ARA. This allows master systems, which do not support ARA, to continue to communicate with the slave power module using the programmed address, and using the various READ_STATUS commands to determine the cause for the SMBALERT. The CLEAR_FAULTS command will retire the active SMBALERT. However, when the power module is used in systems that do support ARA, Bit 4 of the MFR_CPIN_ARA_CONFIG command can be used to reconfigure the module to utilize ARA. In this case, the power module will no longer respond to its programmed address, when in an ALERT active state. The master is expected to perform the modified received byte operation, and retire the ALERT active signal. At this time, the power module will return to its resistor programmed address, allowing normal master-slave

QBDS095A10R6 Technical Specifications (continued)

communications to proceed. The power module does not contain capability to arbitrate data bus contention caused by multiple modules responding to the modified received byte operation. Therefore, when the ARA is used in a multiple module PMBus application, it is necessary to have the power module at the lowest programmed address in order for the host to properly determine all modules' address that are associated with an active SMBAlert. Please contact your sales representative for further assistance, and for more information on the SMBus alert response protocol, see the System Management Bus (SMBus) specification.

PMBus Addressing

The power module has flexible PMBUS addressing capability. By connecting different resistors from Addr1 pin to GND pin, 14 possible addresses can be acquired. The 7bit PMBUS address is defined by the value of the resistor as shown in the table below, and +/-1% resistor accuracy is acceptable. If there is any resistance exceeding the requested range, address 126 will be returned. The address in table below is in decimal.



| PMBUS address | Resistor(Kohm) |
|---------------|----------------|
| 96 | 10 |
| 97 | 15 |
| 98 | 21 |
| 99 | 28 |
| 100 | 35.7 |
| 101 | 45.3 |
| 102 | 56.2 |
| 103 | 69.8 |
| 104 | 88.7 |
| 105 | 107 |
| 106 | 130 |
| 107 | 158 |
| 108 | 191 |
| 109 | 232 |

Figure 27. Circuit showing connection of resistors used to set the PMBus address of the module.

The user must know which I2C addresses are reserved in a system for special functions and set the address of

the module to avoid interfering with other system operations. Both 100kHz and 400kHz bus speeds are supported by the module. Connection for the PMBus interface should follow the High Power DC specifications given in section 3.1.3 in the SMBus specification V2.0 for the 400kHz bus speed or the Low Power DC specifications in section 3.1.2. The complete SMBus specification is available from the SMBus web site, smbus.org.

PMBus Data Formats

For commands that set or report any voltage thresholds related to output voltage (including VOUT_COMMAND, VOUT_MARGIN), the module supports the “VOUT linear” data format consisting of a two byte value with a 16-bit, unsigned mantissa, and a fixed exponent of -12. The format of the two data bytes is shown below:

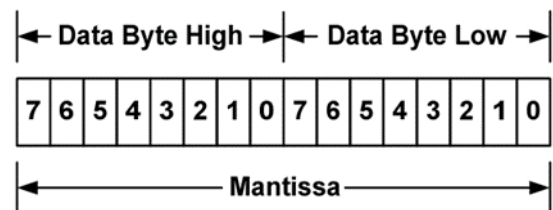

The value of the number is then given by

$$\text{Value} = \text{Mantissa} \times 2^{-12}$$

For commands that set all other thresholds, voltages or report such quantities, the module supports the “linear” data format consisting of a two byte value with an 11-bit, two's complement mantissa and a 5-bit, two's complement exponent. The format of the two data bytes is shown below:

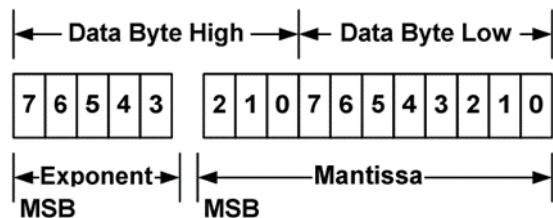

The value of the number is then given by

$$\text{Value} = \text{Mantissa} \times 2^{\text{Exponent}}$$

For both formats, the “low” byte is transmitted first according to the PMBus and SMBus specifications.

QBDS095A10R6 Technical Specifications (continued)

Write Protection

Write protection is enabled by default, to prevent accidentally changing settings. The MFR_DEVICE_TYPE (0xD0) command is used to disable or enable write protection as described below. To keep changes beyond the next removal of input voltage, the STORE_DEFAULT_ALL (0x11) command is used to save all settings to non-volatile memory.

PMBus Enabled On/Off

The module can also be turned on and off via the PMBus interface. The OPERATION command is used to actually turn the module on and off via the PMBus, while the ON_OFF_CONFIG command configures the combination of analog ON/OFF pin input and PMBus commands needed to turn the module on and off. Bit [7] in the OPERATION command data byte enables the module, with the following functions:

- 0 : Output is disabled
- 1 : Output is enabled

This module uses the lower five bits of the ON_OFF_CONFIG data byte to set various ON/OFF options as follows:

| Bit Position | 4 | 3 | 2 | 1 | 0 |
|---------------|----|-----|-----|-----|-----|
| Access | r | r/w | r | r | r |
| Function | PU | CMD | CPR | POL | CPA |
| Default Value | 1 | 1 | 1 | 1 | 1 |

PU: Factory set to 1. QBDS095A10R6 requires On/Off(i) pin to be connected to proper input rail for module to power up. This bit is used together with the CMD, CPR and ON bits to determine startup.

| Bit Value | Action |
|-----------|--|
| 1 | Module does not power up until commanded by the analog ON/OFF pin and the OPERATION command as programmed in bits [2:0] of the ON_OFF_CONFIG register. |

CMD: The CMD bit controls how the device responds to the OPERATION command.

| Bit Value | Action |
|-----------|--|
| 0 | Module ignores the ON bit in the OPERATION command |
| 1 | Module responds to the ON bit in the OPERATION command |

CPR: Factory set to 1. QBDS095A10R6 requires On/Off (i) pin to be connected to proper input rail for module to power up. This bit is used together with the CMD and ON bits to determine startup.

| Bit Value | Action |
|-----------|--|
| 1 | Module requires the analog ON/OFF pin to be asserted to start the unit |

PMBus Adjustable Input Undervoltage Lockout

The module allows adjustment of the input under voltage lockout and hysteresis. The command VIN_ON allows setting the input voltage turn on threshold, while the VIN_OFF command sets the input voltage turn off threshold. For both the VIN_ON and VIN_OFF commands, possible values range from 32.000 to 46.000V in 0.125V steps. VIN_ON must be 2.000V greater than VIN_OFF.

Both the VIN_ON and VIN_OFF commands use the “Linear” format with two data bytes. The upper five bits [7:3] of the high data byte form the two’s complement representation of the exponent, which is fixed at -3 (decimal). The remaining 11 bits are used for two’s complement representation of the mantissa, with the 11th bit fixed at zero since only positive numbers are valid. The data associated with VIN_ON and VIN_OFF can be stored to non-volatile memory using the STORE_DEFAULT_ALL command.

PMBus Adjustable Soft Start Delay and Rise Time

The soft start delay and rise time can be adjusted in the module via PMBus. The TON_DELAY command sets the delay time in ms, and allows choosing delay times between 10ms and 500ms, with resolution of 0.5ms. The TON_RISE command sets the rise time in ms, and allows choosing soft start times between 15ms and 500ms, with resolution of 0.5ms. When setting TON_RISE, make sure that the charging current for output capacitors can be delivered by the module in addition to any load current to avoid nuisance tripping of the overcurrent protection circuitry during startup. Both the TON_RISE and TON_DELAY commands use the “Linear” format with two data bytes. The upper five bits [7:3] of the high data byte form the two’s complement representation of the exponent, which is fixed at -1 (decimal). The remaining 11 bits are used for two’s complement representation of the mantissa, with the 11th bit fixed at zero since only positive numbers are valid. The data associated with TON_RISE and TON_DELAY can be

QBDS095A10R6 Technical Specifications (continued)

stored to non-volatile memory using the STORE_DEFAULT_ALL command.

Output Voltage Adjustment Using the PMBus

The power module output voltage set point is adjusted using the VOUT_COMMAND. The output voltage setting uses the Linear data format, with the 16 bits of the VOUT_COMMAND formatted as an unsigned mantissa, and a fixed exponent of -12 (decimal) (read from VOUT_MODE).

$$VOUT = \text{Mantissa} \times 2^{-12}$$

The range limits for VOUT_COMMAND are 8.10V to 13.20V, and the resolution is 0.244mV.

The data associated with VOUT_COMMAND can be stored to non-volatile memory using the STORE_DEFAULT_ALL command.

Output Voltage Margining Using the PMBus

The power module can also have its output voltage margined via PMBus commands. The command VOUT_MARGIN_HIGH sets the margin high voltage, while the command VOUT_MARGIN_LOW sets the margin low voltage. Both the VOUT_MARGIN_HIGH and VOUT_MARGIN_LOW commands use the “Linear” mode with the exponent fixed at -12 (decimal). The data associated with VOUT_MARGIN_HIGH and VOUT_MARGIN_LOW can be stored to non-volatile memory using the STORE_DEFAULT_ALL command.

The module is commanded to go to the margined high or low voltages using the OPERATION command. Bits [5:2] are used to enable margining as follows:

| | | |
|------|---|----------------------------|
| 00XX | : | Margin Off |
| 0110 | : | Margin Low (Act on Fault) |
| 1010 | : | Margin High (Act on Fault) |

Measuring Output Voltage Using the PMBus

The module can provide output voltage information using the READ_VOUT command. The command returns two bytes of data in the linear format, with the 16 bits of the READ_VOUT formatted as an unsigned mantissa, and a fixed exponent of -12 (decimal).

During module manufacture, an offset correction value is written into the non-volatile memory of the module to null errors in the tolerance and A/D conversion of VOUT. The command MFR_VOUT_READ_CAL_OFFSET can be used to read the offset - two bytes consisting of a signed 16-bit

mantissa in two's complement format, using a fixed exponent of -12 (decimal). The resolution is 0.244mV. The corrected Output voltage reading is then given by:

$$V_{OUT}(\text{Read}) = [V_{OUT}(A/D) + MFR_VOUT_READ_CAL_OFFSET]$$

Measuring Input Voltage Using the PMBus

The module can provide input voltage information using the READ_VIN command. The command returns two bytes of data in the linear format. The upper five bits [7:3] of the high data byte form the two's complement representation of the exponent, which is fixed at -3 (decimal). The remaining 11 bits are used for two's complement representation of the mantissa, with the 11th bit fixed at zero since only positive numbers are valid.

During module manufacture, offset and gain correction values are written into the non-volatile memory of the module to null errors in the tolerance and A/D conversion of Vin. The command MFR_VIN_READ_CAL_OFFSET can be used to read the offset - two bytes consisting of a five-bit exponent (fixed at -3) and a 11-bit mantissa in two's complement format. The resolution is 125mV. The command MFR_VIN_READ_CAL_GAIN can be used to read the gain correction - two bytes consisting of an unsigned 16 bit number. The resolution of this correction factor 0.000122. The corrected input voltage reading is then given by:

$$V_{IN}(\text{Read}) = [V_{IN}(A/D) \times (MFR_VIN_READ_CAL_GAIN / 8192)] + MFR_VIN_READ_CAL_OFFSET$$

Measuring Output Current Using the PMBus

The module measures output current by using the output filter inductor winding resistance as a current sense element. The module can provide output current information using the READ_IOUT command. The command returns two bytes of data in the linear format. The upper five bits [7:3] of the high data byte form the two's complement representation of the exponent, which is fixed at -3 (decimal). The remaining 11 bits are used for two's complement representation of the mantissa, with the 11th bit fixed at zero since only positive numbers are valid. Output current readings are blanked below 1.65A.

QBDS095A10R6 Technical Specifications (continued)

During module manufacture, offset and gain correction values are written into the non-volatile memory of the module to null errors in the tolerance and A/D conversion of IOUT. The command MFR_IOUT_CAL_OFFSET can be used to read the offset - two bytes consisting of a five-bit exponent (fixed at -3) and a 11-bit mantissa in two's complement format. The resolution is 125mA. The command MFR_IOUT_CAL_GAIN can be used to read the gain correction - two bytes consisting of an unsigned 16 bit number. The resolution of this correction factor 0.000122. The READ_IOUT command provides module average output current information. This command only supports positive current sourced from the module. If the converter is sinking current a reading of 0 is provided.

$$I_{OUT}(\text{Read}) = [I_{OUT}(A/D) \times (MFR_IOUT_CAL_GAIN / 8192)] + MFR_IOUT_CAL_OFFSET$$

Note that the current reading provided by the module is corrected for temperature.

Measuring the Temperature using the PMBus

The module can provide temperature information using the READ_TEMPERATURE_1 command. The command returns two bytes of data in the linear format. The upper five bits [7:3] of the high data byte form the two's complement representation of the exponent, which is fixed at -2 (decimal). The remaining 11 bits are used for two's complement representation of the mantissa.

Note that the module's temperature sensor is located close to the module hot spot TH1 (see Thermal Considerations) and is subjected to temperatures higher than the ambient air temperature near the module. The temperature reading will be highly influenced by module load and airflow conditions.

Reading the Status of the Module using the PMBus

The module supports a number of status information commands implemented in PMBus. However, not all features are supported in these commands. A X in the FLAG cell indicates the bit is not supported.

STATUS_WORD : Returns two bytes of information with a summary of the module's fault/warning conditions.

High Byte

| Bit Position | Flag | Default Value |
|--------------|--------------------------|---------------|
| 15 | VOUT fault | 0 |
| 14 | IOUT fault or warning | 0 |
| 13 | Input Voltage fault | 0 |
| 12 | X | 0 |
| 11 | POWER_GOOD# (is negated) | 0 |
| 10 | X | 0 |
| 9 | X | 0 |
| 8 | X | 0 |

Low Byte

| Bit Position | Flag | Default Value |
|--------------|--------------------------|---------------|
| 7 | X | 0 |
| 6 | OFF | 0 |
| 5 | VOUT Overvoltage | 0 |
| 4 | IOUT Overcurrent | 0 |
| 3 | VIN Undervoltage | 0 |
| 2 | Temperature | 0 |
| 1 | CML (Comm. Memory Fault) | 0 |
| 0 | X | 0 |

QBDS095A10R6 Technical Specifications (continued)

STATUS_VOUT : Returns one byte of information relating to the status of the module's output voltage related faults.

| Bit Position | Flag | Default Value |
|--------------|---------------|---------------|
| 7 | VOUT OV Fault | 0 |
| 6 | X | 0 |
| 5 | X | 0 |
| 4 | X | 0 |
| Bit Position | Flag | Default Value |
| 3 | X | 0 |
| 2 | X | 0 |
| 1 | X | 0 |
| 0 | X | 0 |

STATUS_IOUT : Returns one byte of information relating to the status of the module's output current related faults.

| Bit Position | Flag | Default Value |
|--------------|-----------------|---------------|
| 7 | IOUT OC Fault | 0 |
| 6 | X | 0 |
| 5 | IOUT OC Warning | 0 |
| 4 | X | 0 |
| 3 | X | 0 |
| 2 | X | 0 |
| 1 | X | 0 |
| 0 | X | 0 |

STATUS_INPUT : Returns one byte of information relating to the status of the module's input voltage related faults.

| Bit Position | Flag | Default Value |
|--------------|----------------------|---------------|
| 7 | VIN OV Fault | 0 |
| 6 | X | 0 |
| 5 | X | 0 |
| 4 | VIN UV Fault | 0 |
| 3 | Module Off (Low VIN) | 0 |
| 2 | X | 0 |
| 1 | X | 0 |
| 0 | X | 0 |

STATUS_TEMPERATURE : Returns one byte of information relating to the status of the module's temperature related faults.

| Bit Position | Flag | Default Value |
|--------------|------------|---------------|
| 7 | OT Fault | 0 |
| 6 | OT Warning | 0 |
| 5 | X | 0 |
| 4 | X | 0 |
| 3 | X | 0 |
| 2 | X | 0 |
| 1 | X | 0 |
| 0 | X | 0 |

STATUS_CML : Returns one byte of information relating to the status of the module's communication related faults.

| Bit Position | Flag | Default Value |
|--------------|-----------------------------|---------------|
| 7 | Invalid/Unsupported Command | 0 |
| 6 | Invalid/Unsupported Data | 0 |
| 5 | Packet Error Check Failed | 0 |
| 4 | X | 0 |
| 3 | X | 0 |
| 2 | X | 0 |
| 1 | X | 0 |
| 0 | X | 0 |

Black box

There is a black box function realized by D-flash in power module, can record the latest 20 events including status registers, fault time, etc..

Please contact OmniOn representative for details.

QBDS095A10R6 PMBus Commands

Summary of Supported PMBus Commands

This section outlines the PMBus command support for the QBDS095A10R6 bus converters. Each supported command is outlined in order of increasing command codes with a quick reference table of all supported commands included at the end of the section.

Each command will have the following basic information.

Command Name [Code]

Definition

Data format

Factory default

Additional information may be provided if necessary.

OPERATION (0x01)

Command support: On/Off Immediate and Margins (Act on Fault). Soft off with sequencing not supported and Margins (Ignore Fault) not supported.

| | | | | | | | | |
|---------------|----------------------------|-----|-----------|-----|-----------|-----|-----|-----|
| Format | 8 bit unsigned (bit field) | | | | | | | |
| Bit Position | 7 | 6 | 5 | 4 | 3 | 2 | 1 | 0 |
| Access | r/w | r/w | r/w | r/w | r/w | r/w | r/w | r/w |
| Function | ON/OFF | | Bits[5:4] | | Bits[3:2] | | N/A | |
| Default Value | 1 | 0 | 0 | 0 | 0 | 0 | 0 | 0 |

ON_OFF_CONFIG (0x02)

Command support: Bit 1 polarity will be set based upon module code [0=Negative on/off logic, 1=positive on/off logic to allow customer system to know hardware on/off logic

| | | | | | | | | |
|---------------|----------------------------|---|---|----------|-----------|-----------|-------------|-----------|
| Format | 8 bit unsigned (bit field) | | | | | | | |
| Bit Position | 7 | 6 | 5 | 4 | 3 | 2 | 1 | 0 |
| Access | r | r | r | r | r/w | r | r/w | r |
| Function | (reserved) | | | Bit 4 pu | Bit 3 cmd | Bit 2 cpr | Bit 1 pol | Bit 0 cpa |
| Default Value | 0 | 0 | 0 | 1 | 1 | 1 | module code | 1 |

CLEAR_FAULTS (0x03)

Command support: All functionality

STORE_DEFAULT_ALL (0x11)

Command support: All functionality – Stores operating parameters to EEPROM memory.

Command requires ≤ 500ms to execute. Delay any additional commands to module for sufficient time to complete execution.

RESTORE_DEFAULT_ALL[0x12]

Command support: All functionality – Restores operating parameters from EEPROM memory.

Command requires ≤ 200ms to execute. Delay any additional commands to module for sufficient time to complete execution.

QBDS095A10R6 PMBus Commands (continued)

VOUT_MODE[0x20]

Command support: Supported. Factory default: 0x14 – indicates linear mode with exp = -12

| | | | | | | | | |
|---------------|----------------------------|---|---|---|-------------------------|---|---|---|
| Format | 8 bit unsigned (bit field) | | | | | | | |
| Bit Position | 7 | 6 | 5 | 4 | 3 | 2 | 1 | 0 |
| Access | r | r | r | r | r | r | r | r |
| Function | Mode (linear) | | | | 2's complement exponent | | | |
| Default Value | 0 | 0 | 0 | 1 | 0 | 1 | 0 | 0 |

VOUT_COMMAND [0x21]

Command support: Not supported

VOUT_CAL_OFFSET [0x23]

Command support: Not supported

VOUT_MARGIN_HIGH [0x25]

Command support: Not supported

VOUT_MARGIN_LOW [0x26]

Command support: Not supported

VOUT_DROOP [0x28]

Range limits (max/min): 50.0/0

Units: mv/A

Command support: All functionality

VIN_ON [0x35]

Range limits (max/min): 46/39

Units: volt

Command support: All functionality

Note: Special interlock checks between VIN_ON and VIN_OFF maintain a hysteresis gap of 2V minimum and do not allow the OFF level to be higher than and ON level

VIN_OFF [0x36]

Range limits (max/min): 46/32

Units: volt

Command support: All functionality

Note: Special interlock checks between VIN_ON and VIN_OFF maintain a hysteresis gap of 2V minimum and do not allow the OFF level to be higher than and ON level

VOUT_OV_FAULT_LIMIT [0x40]

Range limits (max/min): 15.99/10.9 (See note 2)

Units: volt

Command support: All functionality

Note:

1. Range cross- check – value must be greater than VOUT_COMMAND value.
2. The maximum OV Fault Limit equals the output set point plus 3V, up to 15.99V. This is an automatic module protection feature that will override a user-set fault limit if the user limit is set too high.

QBDS095A10R6 PMBus Commands (continued)

VOUT_OV_FAULT_RESPONSE [0x41]

Command support:

- Response settings (bits RSP0:1) – only a setting of 10, unit shuts down and responds according to the retry settings below, is supported.
- Retry settings (bits RS0:2) – only settings of 000 (unit does not attempt to restart on fault) and 111 unit continuously restarts (normal startup) while fault is present until commanded off, bias power is removed or another fault condition causes the unit to shutdown.
- Delay time setting (bits 0-2) – only DT0:2 = 0 (no delay) supported.

Default Settings: The default settings for the VOUT_OV_FAULT_RESPONSE command are;

- The unit shuts down in response to a VOUT over voltage condition.
- The unit will continuously restart (normal startup) while the VOUT over voltage condition is present until it is commanded off, bias power is removed or another fault condition causes the unit to shut down.
- The shutdown delay is set to 0 delay cycles.

| | | | | | | | | |
|---------------|----------------------------|--------|-------|-------|-------|-------|-------|-------|
| Format | 8 bit unsigned (bit field) | | | | | | | |
| Bit Position | 7 | 6 | 5 | 4 | 3 | 2 | 1 | 0 |
| Access | r | r | r/w | r/w | r/w | r | r | r |
| Function | RSP[1] | RSP[0] | RS[2] | RS[1] | RS[0] | DT[2] | DT[1] | DT[0] |
| Default Value | 1 | 0 | 1 | 1 | 1 | 0 | 0 | 0 |

IOUT_OC_FAULT_LIMIT [0x46]

Range limits (max/min): 150/34

Units: amp

Command support: All functionality

Note: Range cross-check – value must be greater than IOUT_OC_WARN_LIMIT value.

IOUT_OC_FAULT_RESPONSE [0x47]

Command support:

- Response settings (bits RSP0:1) – only settings of 11, unit shuts down and responds according to the retry settings below, is supported.
- Retry settings (bits RS0:2) – only settings of 000 (unit does not attempt to restart on fault) and 111 unit continuously restarts (normal startup) while fault is present until commanded off, bias power is removed or another fault condition causes the unit to shutdown.
- Delay time setting (bits 0-2) – only DT0:2 = 0 (no delay) supported.

Default Settings: The default settings for the IOUT_OC_FAULT_RESPONSE command are;

- The unit shuts down in response to an IOUT over current condition.
- The unit will continuously restart (normal startup) while the IOUT over current condition is present until it is commanded off, bias power is removed or another fault condition causes the unit to shutdown.
- The shutdown delay is set to 0 delay cycles.

| | | | | | | | | |
|---------------|----------------------------|--------|-------|-------|-------|-------|-------|-------|
| Format | 8 bit unsigned (bit field) | | | | | | | |
| Bit Position | 7 | 6 | 5 | 4 | 3 | 2 | 1 | 0 |
| Access | r | r | r/w | r/w | r/w | r | r | r |
| Function | RSP[1] | RSP[0] | RS[2] | RS[1] | RS[0] | DT[2] | DT[1] | DT[0] |
| Default Value | 1 | 0 | 1 | 1 | 1 | 0 | 0 | 0 |

QBDS095A10R6 PMBus Commands (continued)

IOUT_OC_WARN_LIMIT [0x4A]

Range limits (max/min): 150/25

Units: amp

Command support: read/write support, functionality complete

Note: Range cross-check – value must be less than IOUT_OC_FAULT_LIMIT value.

OT_FAULT_LIMIT [0x4F]

Range limits (max/min): 140/25

Units: degrees C.

Command support: All functionality

Note: Range cross-check – value must be greater than OT_WARN_LIMIT value.

OT_FAULT_RESPONSE [0x50]

Command support:

- Response settings (bits RSP0:1) – only setting of 10, unit shuts down and responds according to the retry settings below.
- Retry settings (bits RS0:2) – only settings of 000 (unit does not attempt to restart on fault) and 111 unit continuously restarts (normal startup) while fault is present until commanded off, bias power is removed or another fault condition causes the unit to shutdown.
- Delay time setting (bits 0-2) – only DT0:2 = 0 (no delay) supported.

Default Settings: The default settings for the OT_FAULT_RESPONSE command are;

- The unit shuts down in response to an over-temperature condition.
- The unit will continuously restart (normal startup) while the over-temperature condition is present until it is commanded off, bias power is removed or another fault condition causes the unit to shutdown.
- The shutdown delay is set to 0 delay cycles.

| Format | 8 bit unsigned (bit field) | | | | | | | |
|---------------|----------------------------|--------|-------|-------|-------|-------|-------|-------|
| Bit Position | 7 | 6 | 5 | 4 | 3 | 2 | 1 | 0 |
| Access | r | r | r/w | r/w | r/w | r | r | r |
| Function | RSP[1] | RSP[0] | RS[2] | RS[1] | RS[0] | DT[2] | DT[1] | DT[0] |
| Default Value | 1 | 0 | 1 | 1 | 1 | 0 | 0 | 0 |

OT_WARN_LIMIT [0x51]

Range limits (max/min): 125/25

Units: degrees C.

Command support: All functionality

Note: Range cross-check – value must be less than OT_FAULT_LIMIT value.

VIN_OV_FAULT_LIMIT [0x55]

Range limits (max/min): 90/48

Units: volt

Command support: All functionality

QBDS095A10R6 PMBus Commands (continued)

VIN_OV_FAULT_RESPONSE [0x56]

Command support:

Response settings (bits RSP0:1) – only settings of 11 (The device's output is disabled while the fault is present.) is supported..

- Retry settings (bits RS0:2) – only settings of 000 (unit does not attempt to restart on fault).
- Delay time setting (bits 0-2) – only DT0:2 = 0 (no delay) supported.

Default Settings: The default settings for the VIN_OV_FAULT_RESPONSE command are;

- The unit shuts down in response to a VIN over voltage condition.
- The unit will continuously prepares to restart (normal startup) while the VIN over voltage condition is present until it is commanded off, bias power is removed, the VIN over voltage condition is removed, or another fault condition causes the unit to shutdown.
- The shutdown delay is set to 0 delay cycles.

| | | | | | | | | |
|---------------|----------------------------|--------|-------|-------|-------|-------|-------|-------|
| Format | 8 bit unsigned (bit field) | | | | | | | |
| Bit Position | 7 | 6 | 5 | 4 | 3 | 2 | 1 | 0 |
| Access | r | r | r | r | r | r | r | r |
| Function | RSP[1] | RSP[0] | RS[2] | RS[1] | RS[0] | DT[2] | DT[1] | DT[0] |
| Default Value | 1 | 1 | 0 | 0 | 0 | 0 | 0 | 0 |

POWER_GOOD_ON [0x5E]

Command support: Not supported

POWER_GOOD_OFF [0x5F]

Command support: Not supported

TON_DELAY [0x60]

Range limits (max/min): 500/0

Units: milliseconds

Command support: full support

TON_RISE [0x61]

Range limits (max/min): 500/12

Units: milliseconds

Command support: full support

STATUS_WORD [0x79]

Command support: full implementation for supported functions (note: Fans, MFR_SPECIFIC, Unknown not supported)

| | | | | | | | | |
|--------------|----------------------------|------------|---------------|-----------------------|--------------|-------------------|--------------------|----------------------------|
| Format | 8 bit unsigned (bit field) | | | | | | | |
| Bit Position | 15 | 14 | 13 | 12 | 11 | 10 | 9 | 8 |
| Access | r | r | r | r | r | r | r | r |
| Function | VOUT | I/POUT | INPUT | MFR_SPEC ¹ | #PWR_GOOD | FANS ¹ | OTHER ¹ | UNKNOWN ¹ |
| Format | 8 bit unsigned (bit field) | | | | | | | |
| Bit Position | 7 | 6 | 5 | 4 | 3 | 2 | 1 | 0 |
| Access | r | r | r | r | r | r | r | r |
| Function | BUSY ¹ | OUTPUT_OFF | VOUT_OV_FAULT | IOUT_OC_FAULT | VIN_UV_FAULT | TEMP | CML | NONE OF ABOVE ¹ |

(1) Not supported

QBDS095A10R6 PMBus Commands (continued)

STATUS_VOUT [0x7A]

Command support: VOUT_OV_FAULT support, all bit reset supported

| | | | | | | | | |
|--------------|----------------------------|---------------------------|---------------------------|----------------------------|----------------------------|----------------------------|----------------------------|----------------------------------|
| Format | 8 bit unsigned (bit field) | | | | | | | |
| Bit Position | 7 | 6 | 5 | 4 | 3 | 2 | 1 | 0 |
| Access | r/reset(1) | r/ reset | r/ reset | r/ reset | r/ reset | r/ reset | r/ reset | r/ reset |
| Function | VOUT_OV_FAULT | VOUT_OV_WARN ¹ | VOUT_UV_WARN ¹ | VOUT_UV_FAULT ¹ | VOUT_MAX_WARN ¹ | TON_MAX_FAULT ¹ | TOFF_MAX_WARN ¹ | VOUT TRACKING ERROR ¹ |

(1) Not supported

STATUS_IOUT [0x7B]

Command support: IOUT_OC_FAULT support, all bit reset supported

| | | | | | | | | |
|--------------|----------------------------|-------------------------------|--------------|----------------------------|----------------------------------|-------------------------------------|----------------------------|---------------------------|
| Format | 8 bit unsigned (bit field) | | | | | | | |
| Bit Position | 7 | 6 | 5 | 4 | 3 | 2 | 1 | 0 |
| Access | r/ reset(1) | r/ reset | r/ reset | r/ reset | r/ reset | r/ reset | r/ reset | r/ reset |
| Function | IOUT_OC_FAULT | IOUT_OC_LV_FAULT ¹ | IOUT_OC_WARN | IOUT_UC_FAULT ¹ | Current Share Fault ¹ | In Power Limiting Mode ¹ | POUT_OP_FAULT ¹ | POUT_OP_WARN ¹ |

(1) Not supported

STATUS_INPUT [0x7C]

Command support: VIN_OV_FAULT support, all bit reset supported

| | | | | | | | | |
|--------------|----------------------------|--------------------------|--------------------------|--------------|------------------------------|---------------------------|--------------------------|--------------------------|
| Format | 8 bit unsigned (bit field) | | | | | | | |
| Bit Position | 7 | 6 | 5 | 4 | 3 | 2 | 1 | 0 |
| Access | r/ reset(1) | r/ reset | r/ reset | r/ reset | r/ reset | r/ reset | r/ reset | r/ reset |
| Function | VIN_OV_FAULT | VIN_OV_WARN ¹ | VIN_UV_WARN ¹ | VIN_UV_FAULT | Unit Off (low input voltage) | IIN_OC_FAULT ¹ | IIN_OC_WARN ¹ | PIN_OP_WARN ¹ |

(1) Not supported

STATUS_TEMPERATURE [0x7D]

Command support: OT_WARN, OT_FAULT supported, all bit reset supported

| | | | | | | | | |
|--------------|----------------------------|----------|----------------------|-----------------------|----------|----------|----------|----------|
| Format | 8 bit unsigned (bit field) | | | | | | | |
| Bit Position | 7 | 6 | 5 | 4 | 3 | 2 | 1 | 0 |
| Access | r/ reset(1) | r/ reset | r/ reset | r/ reset | r/ reset | r/ reset | r/ reset | r/ reset |
| Function | OT_FAULT | OT_WARN | UT_WARN ¹ | UT_FAULT ¹ | reserved | reserved | reserved | reserved |

(1) Not supported

QBDS095A10R6 PMBus Commands (continued)

STATUS_CML [0x7E]

Command support: PEC_FAULT, INVALID_DATA, INVALID_CMD supported, all bit reset supported

| | | | | | | | | |
|--------------|----------------------------|--------------|------------|---------------------------|-------------------------|----------|--------------------------------|--|
| Format | 8 bit unsigned (bit field) | | | | | | | |
| Bit Position | 7 | 6 | 5 | 4 | 3 | 2 | 1 | 0 |
| Access | r/ reset(1) | r/ reset | r/ reset | r/ reset | r/ reset | r/ reset | r/ reset | r/ reset |
| Function | INVALID CMD | INVALID DATA | PEC FAILED | MEMORY FAULT ¹ | PROC FAULT ¹ | reserved | COM FAULT (other) ¹ | Memory/ Logic fault (other) ¹ |

(1) Not supported

READ_VIN [0x88]

Command support: full support

READ_VOUT [0x8B]

Command support: full support

READ_IOUT [0x8C]

Command support: full support

READ_TEMPERATURE_1 [0x8D]

Command support: full support

PMBUS_REVISION [0x98]

Command support: full support

| | | | | | | | | |
|---------------|----------------------------|---|---|------------------|---|---|---|---|
| Format | 8 bit unsigned (bit field) | | | | | | | |
| Bit Position | 7 | 6 | 5 | 4 | 3 | 2 | 1 | 0 |
| Access | r | r | r | r | r | r | r | r |
| Function | Part I Revision | | | Part II Revision | | | | |
| Default Value | 0 | 1 | 0 | reserved | 0 | 0 | 1 | 0 |

*See Table below:

| PMBus Revision Data Byte Contents | | | | |
|-----------------------------------|-----------------|----------|------------|------------------|
| Bits [7:5] | Part I Revision | Bit [4] | Bits [3:0] | Part II Revision |
| 000 | 1.0 | Not used | 0000 | 1.0 |
| 001 | 1.1 | Not used | 0001 | 1.1 |
| 010 | 1.2 | Not used | 0010 | 1.2 |

QBDS095A10R6 PMBus Commands (continued)

MFR_DEVICE_TYPE [0xD0]

Command support: partial support in place (Mod Name)

- Present module designations (Non-isolated units will have a OXXXXX format)

| | | | | | | | | | | | | | | | | |
|----------|-----------------|-----|-----|-----|-----|---|---|---|-------------|-----|-----|-----|-----|-----|-----|-----|
| Format | Unsigned Binary | | | | | | | | | | | | | | | |
| Bit Pos. | 7 | 6 | 5 | 4 | 3 | 2 | 1 | 0 | 7 | 6 | 5 | 4 | 3 | 2 | 1 | 0 |
| Access | r/w | r/w | r/w | r/w | r/w | r | r | r | r/w | r/w | r/w | r/w | r/w | r/w | r/w | r/w |
| Function | Reserved | | | | | | | | Module Name | | | | | | WPE | Res |
| Default | 0 | 0 | 0 | 0 | 0 | 0 | 0 | 0 | 1 | 0 | 1 | 0 | 1 | 0 | 1 | 0 |

| Byte | Bit | Description | Value | Meaning |
|-----------|-----|--------------------------|-------|----------------------------------|
| High Byte | 7:0 | Reserved | | |
| Low Byte | 7:2 | Module Name ¹ | 1xxxx | Module Name |
| | 1 | WPE | 0 | Write Protect Enable not active. |
| | | | 1 | Write Protect Enable active. |
| | 0 | Reserved | 0 | Reserved |

- QBDS095A10R6xxx: [6 bits TBD]

MFR_VOUT_READ_CAL_GAIN [0xD1]

Factory default: 0x2000

Range limits (max/min): 0x2000*1.2 / 0x2000*0.8

Units: N/A

Command support: support for VOUT gain calibration (factor in flash), lockout per MFR_DEVICE_TYPE

MFR_VOUT_READ_CAL_OFFSET [0xD2]

Range limits (max/min): exp must = -12

Units: N/A

Data format: VOUT linear except with a two's complement (signed) mantissa

Command support: support for VOUT offset calibration (factor in flash), lockout per MFR_DEVICE_TYPE

MFR_VIN_READ_CAL_GAIN [0xD3]

Factory default: 0x2000

Range limits (max/min): 0x2000*1.2 / 0x2000*0.8

Command support: support for VIN gain calibration (factor in flash), lockout per MFR_DEVICE_TYPE

MFR_VIN_READ_CAL_OFFSET [0xD4]

Data format: VIN linear format

Range limits (max/min): exp must = -3

Units: N/A

Command support: support for VIN offset calibration (factor in flash), lockout per MFR_DEVICE_TYPE

QBDS095A10R6 PMBus Commands (continued)

MFR_IOUT_CAL_GAIN [0xD6]

Factory default: 0x2000

Range limits (max/min): 0x2000*1.2 / 0x2000*0.8

Units: N/A

Command support: support for IOUT gain calibration, lockout per MFR_DEVICE_TYPE

MFR_IOUT_CAL_OFFSET [0xD7]

Range limits (max/min): exp must = -3

Units: N/A

Command support: support for IOUT offset calibration, lockout per MFR_DEVICE_TYPE

MFR_FW_REV [0xDB]

Range limits (max/min): 9999/0000

Units: N/A

Command support: full read support

Format: 4 hex characters: Major revision, Minor revision, Build high, Build low (0xMj.Mn.Bh.Bl)

Example: 0x1218 indicates firmware revision 1.2.18.

MFR_ARA_CONFIG [0xE0]

Command support: Full support.

| Command | MFR_ARA_CONFIG | | | | | | | |
|---------------|----------------------------|---|---|-----|----------|-----|-----|-----|
| Format | 8 bit unsigned (bit field) | | | | | | | |
| Bit Position | 7 | 6 | 5 | 4 | 3 | 2 | 1 | 0 |
| Access | r | r | r | r/w | r/w | r/w | r/w | r/w |
| Function | Reserved | | | ARA | Reserved | | | |
| Default Value | 0 | 0 | 0 | 0 | 0 | 0 | 0 | 0 |

| Bit | Description | Value | Meaning |
|-----|-------------|-------|---|
| 7:5 | Reserved | 000 | Reserved |
| 4 | ARA | 0 | ARA not functional, module remains at resistor programmed address when SMBLAERT is asserted |
| | | 1 | ARA functional, module responds to ARA only, when SMBLAERT is asserted |
| 3:0 | Reserved | | Reserved |

MFR_PGOOD_POLARITY [0xE2]

Command support: full support (bit 0) as follows:

Bit 0: 0 = Negative PGOOD logic (module PGOOD asserted when pin is LO, PGOOD de-asserted when pin is HI)

1 = Positive PGOOD logic (module PGOOD de-asserted when pin is LO, PGOOD asserted when pin is HI)

| Command | MFR_PGOOD_POLARITY | | | | | | | |
|---------------|----------------------------|---|---|---|---|---|---|-------|
| Format | 8 bit unsigned (bit field) | | | | | | | |
| Bit Position | 7 | 6 | 5 | 4 | 3 | 2 | 1 | 0 |
| Access | r | r | r | r | r | r | r | r/w |
| Function | Reserved | | | | | | | logic |
| Default Value | 0 | 0 | 0 | 0 | 0 | 0 | 0 | 1 |

MFR_MODULE_DATE_LOC_SN [0xF0]

Command support: read/write support for 12 byte block, lockout per MFR_DEVICE_TYPE

QBDS095A10R6 PMBus Commands (continued)

PMBus Command Quick Reference Table

| PMBUS CMD | CMD CODE | DATA BYTES | DATA FORMAT | DATA UNITS | TRANSFER TYPE* | DEFAULT VALUE |
|--------------------------|----------|------------|--------------------|------------|----------------|--------------------------------------|
| OPERATION | 0x01 | 1 | Bit field | N/A | R/W byte | 0x88 |
| ON_OFF_CONFIG | 0x02 | 1 | Bit field | N/A | R/W byte | 0x1D (Neg Logic) 0x1F (Pos Logic) |
| CLEAR_FAULTS | 0x03 | 0 | N/A | N/A | Send byte | none |
| STORE_DEFAULT_ALL | 0x11 | 0 | N/A | N/A | Send byte | none |
| RESTORE_DEFAULT_ALL | 0x12 | 0 | N/A | N/A | Send byte | none |
| VOUT_MODE | 0x20 | 1 | mode + exp | N/A | Read byte | 0x14 |
| VOUT_COMMAND | 0x21 | 2 | VOUT linear | Volts | R/W word | |
| VOUT_CAL_OFFSET | 0x23 | 2 | VOUT linear | Volts | R/W word | |
| VOUT_MARGIN_HIGH | 0x25 | 2 | VOUT linear | Volts | R/W word | |
| VOUT_MARGIN_LOW | 0x26 | 2 | VOUT linear | Volts | R/W word | |
| VOUT_DROOP | 0x28 | 2 | linear | mV/A | R/W word | 0 (without -P) 1 (with -P) |
| VIN_ON | 0x35 | 2 | linear | V | R/W word | 44 V |
| VIN_OFF | 0x36 | 2 | linear | V | R/W word | 40.25V |
| VOUT_OV_FAULT_LIMIT | 0x40 | 2 | VOUT linear | V | R/W word | 15V |
| VOUT_OV_FAULT_RESPONSE | 0x41 | 1 | Bit field | N/A | R/W byte | 0xB8 |
| IOUT_OC_FAULT_LIMIT | 0x46 | 2 | linear | Amps | R/W word | 110A |
| IOUT_OC_FAULT_RESPONSE | 0x47 | 1 | Bit field | N/A | R/W byte | 0xC0 |
| IOUT_OC_WARN_LIMIT | 0x4A | 2 | linear | Amps | R/W word | 106A |
| OT_FAULT_LIMIT | 0x4F | 2 | linear | Deg. C | R/W word | 130C |
| OT_FAULT_RESPONSE | 0x50 | 1 | Bit field | N/A | R/W byte | 0x80 |
| OT_WARN_LIMIT | 0x51 | 2 | linear | Deg. C | R/W word | 116C |
| VIN_OV_FAULT_LIMIT | 0x55 | 2 | linear | V | R/W word | 63V |
| VIN_OV_FAULT_RESPONSE | 0x56 | 1 | Bit field | N/A | R/W byte | 0xC0 |
| POWER_GOOD_ON | 0x5E | 2 | VOUT linear | V | R/W word | |
| POWER_GOOD_OFF | 0x5F | 2 | VOUT linear | V | R/W word | |
| TON_DELAY | 0x60 | 2 | linear | msec | R/W word | 0ms |
| TON_RISE | 0x61 | 2 | linear | msec | R/W word | 15ms (without -P) 15ms (with -P) |
| STATUS_WORD | 0x79 | 2 | Bit field | N/A | Read word | N/A |
| STATUS_VOUT | 0x7A | 1 | Bit field | N/A | Read byte | N/A |
| STATUS_IOUT | 0x7B | 1 | Bit field | N/A | Read byte | N/A |
| STATUS_INPUT | 0x7C | 1 | Bit field | N/A | Read byte | N/A |
| STATUS_TEMPERATURE | 0x7D | 1 | Bit field | N/A | Read byte | N/A |
| STATUS_CML | 0x7E | 1 | Bit field | N/A | Read byte | N/A |
| READ_VIN | 0x88 | 2 | linear | v | Read word | N/A |
| READ_VOUT | 0x8B | 2 | VOUT linear | v | Read word | N/A |
| READ_IOUT | 0x8C | 2 | linear | Amps | Read word | N/A |
| READ_TEMP1 | 0x8D | 2 | linear | Deg. C | Read word | N/A |
| PMBUS_REVISION | 0x98 | 1 | Bit Field | n/a | Read byte | 1.2 |
| MFR_DEVICE_TYPE | 0xD0 | 2 | Custom | N/A | R/W word | 0x00CE |
| MFR_VOUT_READ_CAL_GAIN | 0xD1 | 2 | 16 bit unsigned | N/A | R/W word | 0x2000 |
| MFR_VOUT_READ_CAL_OFFSET | 0xD2 | 2 | mod VOUT linear | N/A | R/W word | MS |
| MFR_VIN_READ_CAL_GAIN | 0xD3 | 2 | 16 bit unsigned | N/A | R/W word | MS |
| MFR_VIN_READ_CAL_OFFSET | 0xD4 | 2 | linear | N/A | R/W word | MS |
| MFR_IOUT_CAL_GAIN | 0xD6 | 2 | 16 bit unsigned | N/A | R/W word | MS |
| MFR_IOUT_CAL_OFFSET | 0xD7 | 2 | linear | N/A | R/W word | MS |
| MFR_FW_REV | 0xDB | 2 | 16 bit unsigned | N/A | Read byte | TBD |
| MFR_ARA_CONFIG | 0xE0 | 1 | Bit field | N/A | R/W byte | |
| MFR_PGOOD_POLARITY | 0xE2 | 1 | Bit field | N/A | R/W byte | 0x00 |
| MFR_MOD_DATE_LOC_SN | 0xF0 | 12 | 8 bit char | N/A | R/W block | YYLLWW123456 |

*Some Write commands are ignored until Write Protection is disabled using the MFR_DEVICE_TYPE (0xD0) command. These are identified by "lockout per MFR_DEVICE_TYPE" in the preceding detailed command descriptions.

QBDS095A10R6 Mechanical Specifications

Mechanical Outline for QBDS095A10R6*-*HZ (Base plate) Through-hole Module

Dimensions are in millimeters and [inches].

Tolerances: x.x mm ± 0.5 mm [x.xx in. ± 0.02 in.] (Unless otherwise indicated)

x.xx mm ± 0.25 mm [x.xxx in ± 0.010 in.]

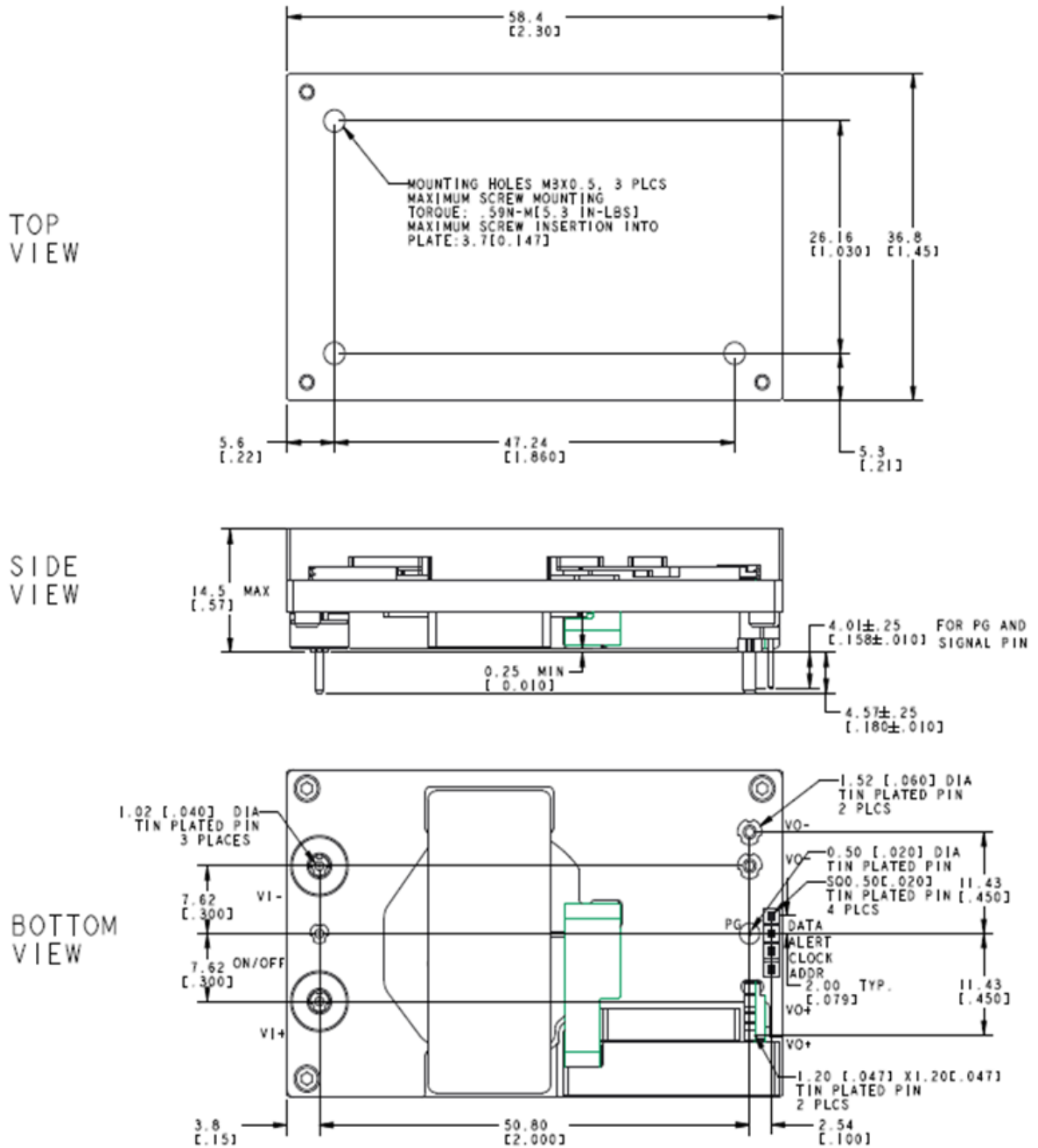

QBDS095A10R6 Mechanical Specifications (continued)

Recommended Pad Layouts

Dimensions are in millimeters and (inches).

Tolerances: x.x mm ± 0.5 mm [x.xx in. ± 0.02 in.] (unless otherwise indicated)

x.xx mm ± 0.25 mm [x.xxx in ± 0.010 in.]

| Pin Number | Pin Name |
|------------|----------|
| 1 | VIN(+) |
| 2 | ON/OFF |
| 3 | VIN(-) |
| 4 | VOUT(-) |
| 5 | VOUT(-) |
| 6 | VOUT(+) |
| 7 | VOUT(+) |
| 8 | Data |
| 9 | Alert |
| 10 | Clock |
| 11 | AddrT |
| 12 | PGOOD |

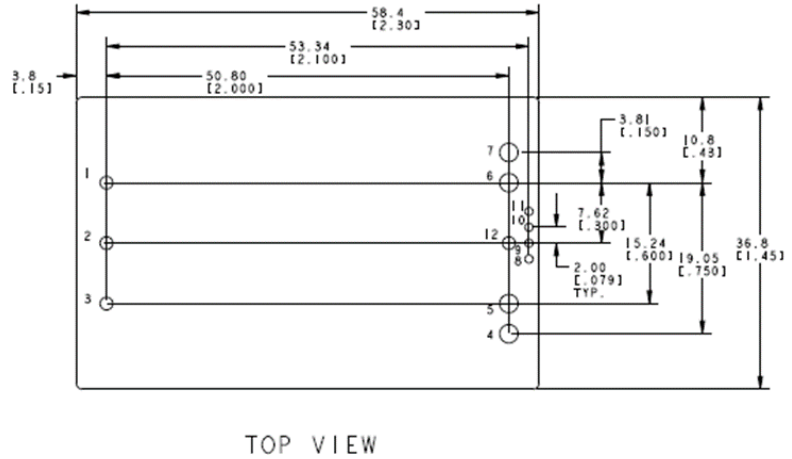

Hole and Pad diameter recommendations:

| Pin Number | Hole Dia mm [in] | Pad Dia mm [in] |
|--------------|------------------|-----------------|
| 1, 2, 3 | 1.6 [.063] | 2.1 [.083] |
| 8,9,10,11,12 | 1.0 [.039] | 1.5 [.059] |
| 4,5,6,7 | 2.3 [.091] | 3.3 [.130] |

Packaging Details

All versions of the QBDS095A10R6 are supplied as standard in the plastic trays shown in Figure 27.

Tray Specification

| | |
|-------------------------|---|
| Material | PET (1mm) |
| Max surface resistivity | 10 ⁹ -10 ¹¹ W/PET |
| Color | Clear |
| Capacity | 12 power modules |
| Min order quantity | 24 pcs (1 box of 2 full trays + 1 empty top tray) |

Each tray contains a total of 12 power modules. The trays are self-stacking and each shipping box for the QBDS095A10R6 module contains 2 full trays plus one empty hold-down tray giving a total number of 24 power modules.

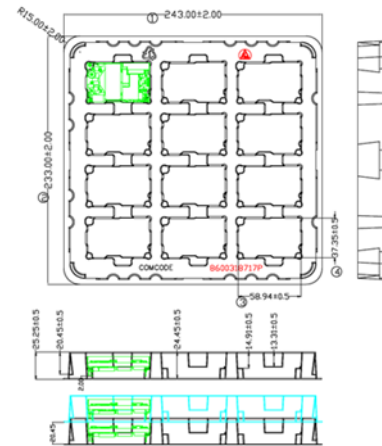

Base Plate Module Tray
Figure 27. QBDS095A10R6 Packaging Tray

QBDS095A10R6 Ordering Information

Ordering Information

Please contact your OmniOn Sales Representative for pricing, availability and optional features.

Table 1. Device Codes.

| Product Codes | Input Voltage | Output Voltage | Output Power | Efficiency | Connector Type | MSL Ra-ting | Comcodes |
|-------------------|-------------------|-----------------|--------------|----------------------------------|----------------|-------------|-------------|
| QBDS095A10R61-PHZ | 54V (45-56Vdc) | 10.6V @54Vin | 1000w | 96.7% @P _{out} =700w | Through hole | 2a | 1600419612A |

Table 2. Device Options.

| Characteristic | Character and Position | | | | | | | | | | Definition | |
|--------------------------------------|------------------------|----|---|------|------|---|---|---|---|----|------------|---|
| Form Factor | Q | | | | | | | | | | | Q = Quarter Brick |
| Family Designator | | BD | | | | | | | | | | BD = BARRACUDA Digital Series with PMBus |
| Input Voltage | | | S | | | | | | | | | S = Special input voltage 45V - 56V |
| Output Power | | | | 095A | | | | | | | | 095A = 95A Rated Output Current |
| Output Voltage | | | | | 10R6 | | | | | | | 10R6 = 10.6V nominal |
| Pin Length | | | | | | 8 | | | | | | Omit = Default Pin Length shown in Mechanical 8 = Pin Length: 2.79 mm ± 0.25mm, (0.110 in. ± 6 = Pin Length: 3.68 mm ± 0.25mm, (0.145 in. ± |
| | | | | | | 6 | | | | | | |
| Action following Protective Shutdown | | | | | | | 4 | | | | | Omit = Latching Mode 4 = Auto-restart following shutdown (Overcurrent/Overvoltage) |
| On/off Logic | | | | | | | | 1 | | | | Omit = Positive Logic 1 = Negative Logic |
| | | | | | | | | | - | | | |
| | | | | | | | | | | xx | | Custom version |
| Load share | | | | | | | | | | P | | P = Forced Droop Output for use in parallel |
| Heat Plate | | | | | | | | | | H | | H = Heat plate, for use with a heat sink or cold wall |
| RoHS | | | | | | | | | | | Z | Z = RoHS 6/6 Compliant, Lead free |

QBDS095A10R6 Change History (excludes grammar & clarifications)

| Revision | Date | Description of the change |
|----------|------------|--|
| 1.1 | 10-22-2021 | Initial Release (identical to -62 version) |
| 1.2 | 11-22-2023 | Updated as per OmniOn template |

OmniOn Power Inc.

601 Shiloh Rd.
Plano, TX USA

omnionpower.com

We reserve the right to make technical changes or modify the contents of this document without prior notice. OmniOn Power does not accept any responsibility for errors or lack of information in this document and makes no warranty with respect to and assumes no liability as a result of any use of information in this document.

We reserve all rights in this document and in the subject matter and illustrations contained therein. Any reproduction, disclosure to third parties or utilization of its contents – in whole or in parts – is forbidden without prior written consent of OmniOn Power. This document does not convey license to any patent or any intellectual property right. Copyright© 2023 OmniOn Power Inc. All rights reserved.