

EP1000-UTEZ short-depth power supplies

EP1000-UTEZ: 90 - 264V_{AC} Input; 48V_{DC} Output; 1000 Output Power



The EP1000-UTEZ is a single phase, hot-pluggable, fan cooled ACDC power supply that provides highly reliable DC power. The EP1000-UTEZ is a cost-effective power supply that occupy just 1RU and its shallow depth is an ideal power solution for depth critical applications. The constant output power characteristics as well as the extended temperature range, universal AC input voltage range and compact size are key attributes that make this product the right choice for your power needs.

This power supply is applicable for indoor and outdoor environments. It communicates digitally to the Pulsar Edge controller family over a RS485 bus to add extensive monitoring and alarm management facilities. Its flexible and sophisticated feature set makes this front-end supply an excellent choice for power in a variety of applications. A large population in the field demonstrate excellent real-life reliability.

Applications

- Industrial equipment
- Telecommunications equipment

Features

- Compact size: 126.5 mm x 206 mm x 41.6 mm (5 in x 8.1 in x 1.64 in)
- Universal AC Input Range (90 – 264V_{AC})
- Output voltage of 48V
- 1000W Max. from nominal 200-240V_{AC}
- Maximum output current of 22A@ 48V_{out} (1000W)
- Temperature controlled fan cooling, front to rear
- High efficiency (>94% at half load, 230V_{AC} in)
- Full load capability at 50°C with derating at higher temperatures
- Galaxy Protocol RS485 communications
- Output overcurrent protection (non-latching)
- Overtemperature protection
- Output overvoltage protection
- Minimum of 11ms of holdup time***
- Parallelable with output current sharing
- Active power factor corrected input
- Conducted EMI - meets CISPR32 (EN55032) and FCC Class A requirements
- Meets IEC61000-4-5, Level 4 (2kV/4kV)
- Compliant to RoHS Directive 2011/65/EU and amended Directive (EU) 2015/863
- UL and cUL approved to UL/CSA†62368-1, TUV (EN62368-1), CE Mark (for) LVD and CB Report available.
- ISO** 9001 and ISO 14001 certified manufacturing facilities
- All PCBs are conformally coated

* UL is a registered trademark of Underwriters Laboratories, Inc.

† CSA is a registered trademark of Canadian Standards Association.

‡ VDE is a trademark of Verband Deutscher Elektrotechniker e.V.

** ISO is a registered trademark of the International Organization of Standards

*** 230V_{IN}, 48V_O, 22A_O, T_a>-10°C, output allowed to decay to 30V_{DC}

Technical Specifications

Absolute Maximum Ratings

Stresses in excess of the absolute maximum ratings can cause permanent damage to the device. These are absolute stress ratings only, functional operation of the device is not implied at these or any other conditions in excess of those given in the operations sections of the data sheet. Exposure to absolute maximum ratings for extended periods can adversely affect the device reliability.

Parameter	Device	Min	Max	Unit
Input Voltage – Continuous operation	All	90	264	V _{AC}
Input Voltage – no damage	All	0	285	V _{AC}
Operating Ambient Temperature (see Thermal Considerations section)	All	-40	75	°C
Storage Temperature	All	-40	85	°C
Humidity (non-condensing)	All	5	95	%
Altitude	All	-400	4000	m
Isolation Voltage – Input to output	All		3000	V _{AC}
Input to safety ground	All		1500	V _{AC}
Outputs to safety ground	All		1000	V _{AC}

Electrical Specifications

Parameter	Device	Min	Typ	Max	Unit
Operating Input Voltage (1200W for V _{IN} = 90-175V _{AC})	All	90	115/230	264	V _{AC}
Input Source Frequency	All	47	50/60	63	Hz
Input Current EP1000-UTEZ (V _{IN} = 90V _{AC})	All			12.5	A _{Max}
Input Power Factor (230V _{AC} , Full Load)	All	0.96	0.99		
Inrush Transient Current (V _{IN} = 265V _{AC} , T _{amb} = 25°C)	All			25	A _{Peak}
Leakage Current to earth ground (V _{IN} = 265V _{AC})	All			3.5	mA
Output Voltage Setpoint (as shipped by OmniOn)	All		48		V _{DC}
Output Voltage Tolerance (due to set point, temperature variations, load and line regulation)	All	-1		1	%
Output Voltage Adjustment Range	All	30		52	V _{DC}
Output Power High Line (nominal 200-240V _{AC}) Low Line (nominal 100-120V _{AC})		0		1000	W
Output Load Regulation	All			1	%V _{out}
Output Line Regulation	All			0.5	%V _{out}
Output Ripple and Noise – measured with 230V _{AC} in, 48V _{out} , 0.1µF ceramic capacitor in parallel with 10µF electrolytic capacitor Peak-to-peak (20MHz Bandwidth)	All			500	mV _{p-p}
Dynamic Load Response – 50% to 75% load transient, 1°/µs slew rate Output voltage deviation	All			5	%
Settling Time	All			5	ms
Output Current EP1000-UTEZ High Line (nominal 200-240V _{AC}) Low Line (nominal 100-120V _{AC})	All	0 0		22 22	A _{DC}

Technical Specifications (continued)

Electrical Specifications (continued)

Parameter	Device	Min	Typ	Max	Unit
Output Current Limit Inception	All	21	22	23	A _{DC}
Output Capacitance (per unit)	All	0		10000	μF
Overvoltage protection	All	59	59.5	59.99	V _{DC}
Current Share Accuracy	All		+/-3	+/-5	%rated
Efficiency					
V _{IN} = 230V _{AC} , 20% load	All	87.5	88.68		%
50% load	All	92	93.77		
100% load	All	93	94.82		
V _{IN} = 115V _{AC} , 20% load	All	85.5	86.94		
50% load	All	90	91.37		
100% load	All	89	90.50		
Holdup Time – V _{IN} = 115V _{AC} , 48V _o , 22A _o , T _a >-10°C, output allowed to decay to 30V _{DC}	All	10		22	ms
V _{IN} = 230V _{AC} , 48V _o , 22A _o , T _a >-10°C, output allowed to decay to 30V _{DC}	All	11			ms

General Specifications

Parameter	Device	Symbol	Typ	Unit
Calculated Reliability based on Telcordia SR-332 Issue 2: Method 1Case 3 (V _{IN} =230V _{AC} , I _o = 32A, T _A = 40°C, 90% confidence)	All	MTBF	>250,000	Hours
Weight	All		1400 49.5	g oz.
Service Life	All		10	Years minimum

Feature Specifications

Parameter	Device	Min	Typ	Max	Unit
Turn-on delay	All		5		s
Output Voltage Rise Time (walk-in disabled)	All		100		ms
Output Voltage Rise Time (walk-in enabled)	All		20		s
Output Overvoltage Protection	All	59	59.5	59.99	V _{DC}
Input Undervoltage lockout					
Turn-on Threshold (100% load)	All	80	85	90	V _{AC}
Turn-off Threshold (100% load)	All	75	80	85	V _{AC}
Input Overvoltage lockout					
Turn-off threshold	All		275		V _{AC}
Turn-on threshold	All		270		V _{AC}

Technical Specifications (continued)

Environmental Specifications

Parameter	Device	Specification/Test
Radiated Emissions (230V50Hz in, 48V 22A out)	All	CISPR32 Class A with 3dB margin
Conducted Emissions (230V50Hz in, 48V 22A out)	All	CISPR32 Class A with 6dB margin
ESD	All	IEC61000-4-2, Level 3 no errors, 4 no damage
Radiated Susceptibility	All	IEC61000-4-3, Level 3, 10V/m
Electrical Fast Transient Common Mode	All	IEC61000-4-4, Level 3, +/-2kV
Surge Immunity	All	IEC61000-4-5, Level 4
Conducted RF Immunity	All	IEC61000-4-6, Level 3, no errors
Input Voltage Dips	All	Output stays within regulation for either ½ cycle interruption or 25% dip from nominal line for 1 second
Input Harmonics	All	IEC61000-3-2
Shock and Vibration	All	Per IPC-9592B, Class II
Voltage Fluctuations	All	EN61000-3-3, no errors
Conducted RF	All	EN61000-4-6, level 3, no errors, 10Vrms
Radiated H field	All	EN61000-4-8, no errors, 30A/m
Ambient temperature, operating	All	-40°C to +75°C, start up at -40°C
Ambient temperature, transport	All	-40°C to +85°C, ETSI EN 300 019-1
Altitude	All	-400m to +4000m, derate by 1C for every 200m above 2000m
Audible noise	All	<55dBA, for 3 units in a shelf, to meet GR-63 Core

Safety Specifications

Parameter	Device	Specification
Dielectric Withstand Voltage (between input and output)	All	Minimum of 4,250V _{DC} for 1 minute
Insulation Resistance (between input and output)	All	Minimum of 5 MW
Safety Standards	All	Class 1, IEC62368-1, EN62368, with the following deviations: Nemko, UL 62368-1 (Recognized Component), cUL (Canadian Approval by UL)

Technical Specifications (continued)

Safety Considerations

The EP1000 power supply is intended for inclusion in other equipment and the installer must ensure that it is installed in compliance with all the requirements of the end application. This product is only for inclusion by professional installers within other equipment and must not be operated as a stand-alone product. The power supply meets Class 1, IEC62368, EN62368, with the following deviations: Nemko. UL62368 (Recognized Component) C-UL (Canadian Approval by UL).

This power supply has fuses in both the “Live” and “Neutral” input lines. Therefore, it may be connected in a phase to phase arrangement with safety, or via wall pugs where Live and Neutral cannot be resolved.

Feature Descriptions

Processor Back Bias Power Supply (A29)

The EP1000 has a back-bias which permits communication with and monitoring of a unit with AC input not present. A single unit shall be able to back-bias a minimum of four others in the same system. The back-bias shall be ~8V and assigned to A29 of the unit’s interface. This is not intended for any other use.

Enable (A26)

Connect this pin to GND (A27) to enable the unit to run. A26 should be connected to A27 via a 1k resistor.

Power supply off (B24)

This is a power supply disable signal. It is an opto-isolator diode with 1000R in series. Pass between 3mA and 6mA to turn the power supply off. This pin is referenced to the ALARM-GND (B23).

Power supply present (B26)

This pin is connected to the ALARM-GND pin (B23) inside the unit. Use it for external detection of the presence or absence of the unit.

Address 2, 1, 0 (B28, A28, B27 respectively)

Use the address pins to give each power supply in the system a unique address. If there is no controller, give the power supply the address 111 to stop the front panel LED flashing to indicate communications failure. The address lines have internal pullups. Pull them to GND to set them to 0.

RS485 A, B, gnd (B29, B30, A30 respectively)

Use these pins to communicate with the power supply. Either use a OmniOn controller or your own. If you are not using a OmniOn controller, there is a separate document which explains how OmniOn Galaxy Protocol runs over the RS485 hardware layer. Rectifier addressing and use of the RS485 is given in document 11ESTR000, available on request.

Output Voltage Adjustment

The output voltage is capable of being adjusted between 30V and 52V using RS485 communications. When the power supply first powers up it will produce the most recently programmed voltage. Our factory ships at 48V. After that it will revert to the most recently programmed voltage.

The frame grounding can be connected such that the power supply may have a positive, or negative, or no ground connection.

Current Share Bus

Pins A25 and B25 are a current sharing signal bus. If you are going to connect the power outputs of multiple units together in parallel, then connect the current share bus. If you have multiple units in the system feeding separate loads, do not connect the current share bus.

Overcurrent Protection

To provide protection in a fault condition (output overload), the power supply is equipped with internal current-limiting circuitry and can endure current limiting continuously. The power supply operates normally once the output current is brought back into its specified range.

Overvoltage Protection

Overvoltage protection is a feature of the power supply that protects both the load and the power supply from an output overvoltage condition. When an overvoltage occurs, the power supply shuts down and restarts once the overvoltage condition is removed. It is not necessary to recycle the input to restart the power supply when this protection is activated.

Overtemperature Protection

The EP1000 also features overtemperature protection in order to provide additional protection in a fault condition.

Technical Specifications (continued)

The power supply is equipped with a thermal shutdown circuit which detects excessive internal temperatures and shuts the unit down. Once the power supply goes into overtemperature shutdown, it will cool before attempting to restart.

Input Under-voltage Lockout

At input voltages below the input under-voltage lockout limit, power supply operation is disabled. The power supply will begin to operate at an input voltage above the under-voltage lockout turn-on threshold.

Fault signal (A23)

This is an open collector output, with 100R in series. Logic low indicates a healthy state. An open circuit indicates a fault state. Maximum current sink is 3mA. This signal is referenced to ALARM-GND (B23).

Alarm signal (A24)

This is an open collector output with 100R in series. Logic low indicates a healthy state. An open circuit indicates an alarm state. Maximum current sink is 3mA. This signal is referenced to ALARM-GND (B23).

Front Panel LEDs

Three LEDs are located on the front faceplate; run, alarm, and fault. These LEDs will indicate the status of the power supply. The power supply conditions for each LED are in order of priority. If a higher order condition exists then the LED shall take the status defined by that condition.

LED Color	LED Status	Rectifier Condition
Green	OFF	Rectifier off due to: <ul style="list-style-type: none"> AC and DC out of range Alarm LED is on, Except for output current overload conditions/constant power FAULT LED is on, Except for communications failure condition
	BLINK	Rectifier preparing / prepared to produce power <ul style="list-style-type: none"> Rectifier in STAND-BY (PS-OFF or GP command) Rectifier "walking in"
	ON	Rectifier on, producing power and: <ul style="list-style-type: none"> Alarm LED is off, Except for output current overload conditions FAULT LED is off, Except for communications failure condition

LED Color	LED Status	Rectifier Condition
Yellow	OFF	Rectifier off due to AC out off range
	ON	Rectifier in one or more of the following recoverable conditions: <ul style="list-style-type: none"> Output current overload / constant power Over temperature warning

LED Color	LED Status	Rectifier Condition
Red	OFF	Rectifier off due to AC out off range
	ON	Rectifier failure due to: <ul style="list-style-type: none"> Fan Failure AC Failure HVSD Overtemperature shutdown Output short circuit overload
	BLINK	Communications loss with the controller

Rectifier State	LED		
	Run	Alarm	Fault
On and producing power	On	Off	Off
No AC	Off	Off	Off
Stand by GP	Blink	Off	Off
Stand by PS-OFF	Blink	Off	Off
Over current / constant power	On	On	Off
Over temperature warning	On	On	Off
Over temperature shutdown	Off	Off	On
AC failure	Off	Off	On
output short circuit	Off	Off	On
Output under voltage	Off	Off	On
Output over voltage	Off	Off	On
Communications loss	On	Off	Blink

Paralleling Outputs

The EP1000-UTEZ is designed to be connected in parallel with other identical units, and to current share with them. No external OR-ing devices are required.

PCB Conformal Coating

The PCBs inside the EP1000 are conformally coated to prevent mild solid and liquid pollution from affecting performance.

Gold Finger Pin Lengths

The power supply connector consists of gold plated fingers on the main PCB. They have different lengths, so that some can make first on insertion, and some can break first on extraction (dimensions in mm):-



Technical Specifications (continued)

Output voltage ripple

Here is the EP1000 output voltage ripple, with 230V_{IN}, +25°C, 52V, 19.23A:

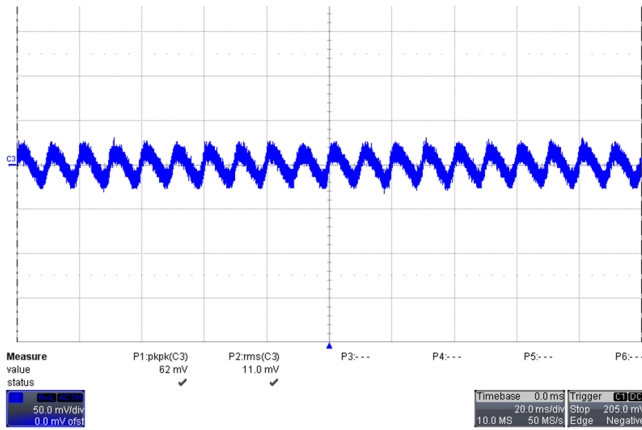

Thermal Considerations

The EP1000 is high efficiency and cools itself with a built-in fan. It will operate over the temperature range -40°C to +75°C, starting at -40°C and meeting specification once internal temperatures reach 20°C. It will dissipate up to 100W. Power supply orientation is unimportant. There is power derating of 2%/°C above 50°C except when V_o is 30-33V_{DC}, then only 15A is available above T_a = 50°C.

Efficiency Characteristic

Here is the efficiency characteristic of the EP1000, with 230V_{IN}, and at temperatures -40°C, +25°C, and +50°C:

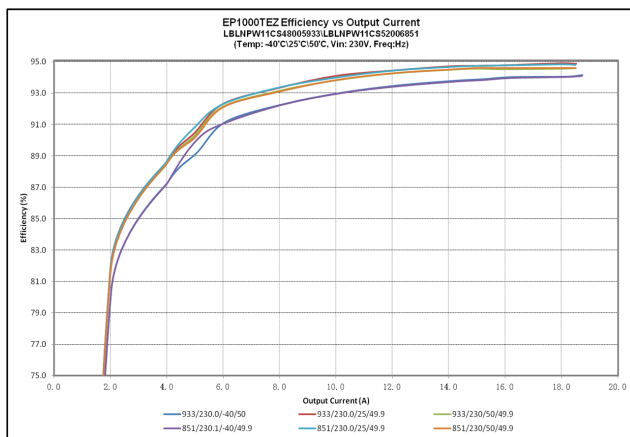

Holdup at 90V_{AC} input

Here is the holdup characteristic of the EP1000, +25°C, 90V_{IN}, 52V, 19.23A:

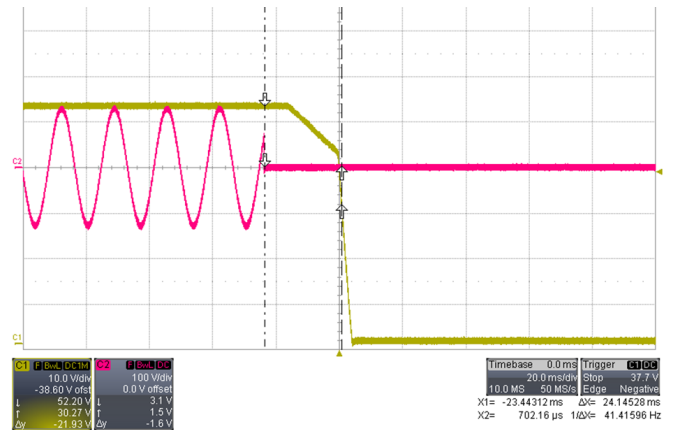

Output Characteristic

Here are the output characteristics of the EP1000-UTEZ.

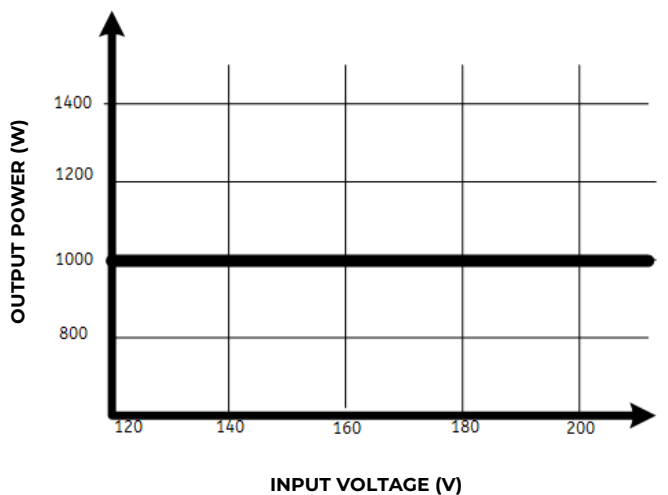
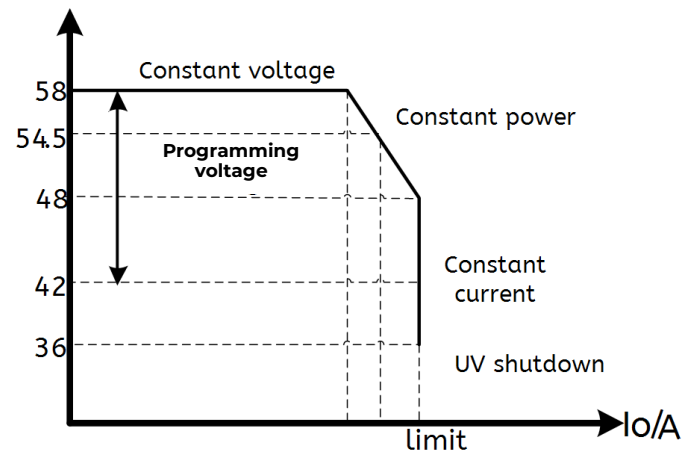

Technical Specifications (continued)

Mechanical Outline

TOP VIEW



SIDE VIEW

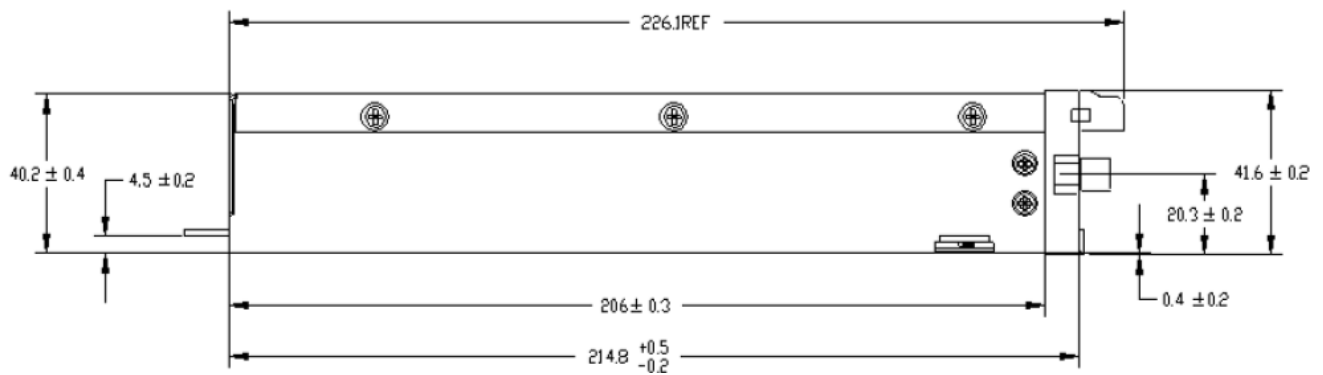

3D-VIEW



Technical Specifications (continued)

Connector Information

Connector	Connector on Power Supply	Mating Connector
AC power, DC power, and Signals	PCB gold finger arrangement	Huafeng CY8-2.54-60(52)ZSWBJ
		If you need this connector, buy it from OmniOn Or a franchised distributor of OmniOn

Pinout Information

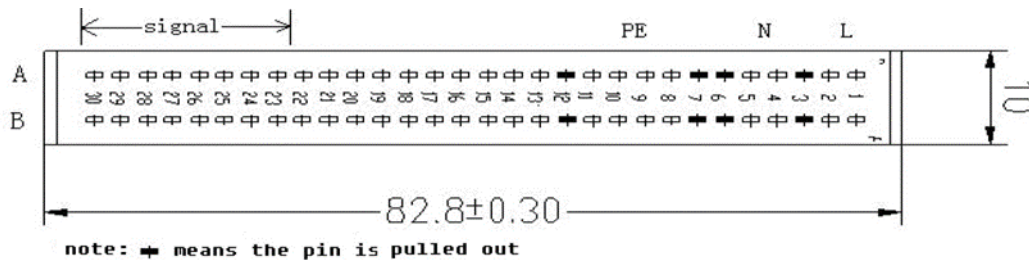

Pin Number	Function
A1, A2, B1, B2	L
A4, A5, B4, B5	N
A8 to A11 B8 to B11	PE
A13 to A22 B13 to B22	48V+
	48V-
A23	FAULT+
A24	ALARM+
B23	ALARM-GND
B24	PS-off
B25	SHARE+
A25	SHARE-
A26	PS-enable
B26	PS-present
A27	GND
B27	ADDR0
A28	ADDR1
B28	ADDR2
A29	8V INT
A30	ComGND
B29	RS485_A
B30	RS485_B

Technical Specifications (continued)

Ordering Information

Please contact your OmniOn Sales Representative for pricing, availability and optional features.

Device Code	Input Voltage Range	Output Voltage	Output Current	RoHS	Output Power	Temperature Range	Ordering code
EP1000-UTEZ	90 – 264V _{AC}	48V _{DC}	22	10	1000	-40 to 75°C	CC109165602
Slot Filler	NA	NA	NA	6	NA	-40 to 75°C	CC848883297

Table 1. Device Codes

EP1000-UTEZ is the product described in this data sheet.

The slot filler, listed above, can be used in OmniOn SPS shelves where there is no intention to fit a power supply. It provides an aesthetic improvement over an empty slot, and it also prevents the insertion of foreign materials into the shelf – eg, tools, fasteners, documentation, or leads.

Change History (excludes grammar & clarifications)

Revision	Date	Description of the change
1.0	01-12-2023	Initial release
1.1	11-09-2023	Updated as per OmniOn template

OmniOn Power Inc.

601 Shiloh Rd.
Plano, TX USA

omnionpower.com

We reserve the right to make technical changes or modify the contents of this document without prior notice. OmniOn Power does not accept any responsibility for errors or lack of information in this document and makes no warranty with respect to and assumes no liability as a result of any use of information in this document.

We reserve all rights in this document and in the subject matter and illustrations contained therein. Any reproduction, disclosure to third parties or utilization of its contents – in whole or in parts – is forbidden without prior written consent of OmniOn Power. This document does not convey license to any patent or any intellectual property right. Copyright© 2023 OmniOn Power Inc. All rights reserved.