

# EHHD036A0F HAMMERHEAD\* Series; DC-DC Converter Power Modules

**18-75V<sub>dc</sub> Input; 3.3V<sub>dc</sub>, 36A, 120W Output**

RoHS Compliant



## Description

The EHHD036A0F [HAMMERHEAD\*] Series, eighth-brick, low-height power modules are isolated dc-dc converters which provide a single, precisely regulated output voltage over an ultra wide input voltage range of 18-75V<sub>dc</sub>. The EHHD036A0F provides 3.3V<sub>dc</sub> nominal output voltage rated for 36A<sub>dc</sub> output current. The module incorporates OmniOn's vast heritage for reliability and quality, while also using the latest in technology, and component and process standardization to achieve highly competitive cost. The open frame module construction,

available in through-hole packaging, enable designers to develop cost and space efficient solutions. The module achieves typical full load efficiency greater than 90% at V<sub>IN</sub>=24V<sub>dc</sub> and V<sub>IN</sub>=48V<sub>dc</sub>. Standard features include remote On/Off, remote sense, output voltage adjustment, overvoltage, overcurrent and overtemperature protection. An optional heat plate allows for external standard, eighth-brick heat sink attachment to achieve higher output current in high temperature applications.

## Applications

- Distributed Power Architectures
- Wireless Networks
- Enterprise Networks including Power over Ethernet (PoE)
- Industrial Equipment

## Options

- Negative Remote On/Off logic (preferred)
- Over current/Over temperature/Over voltage protections (Auto-restart) (preferred)
- 1/8<sup>th</sup> Brick Heat plate for 1/8<sup>th</sup> heatsinks
- 1/4<sup>th</sup> Brick heat plate with unthreaded inserts

See Footnote on Page No. 2

## Features

- Compliant to RoHS II EU “Directive 2011/65/EU” and amended Directive (EU) 2015/863.
- Compliant to REACH Directive (EC) No 1907/2006
- Flat and high efficiency curve
- Industry standard, DOSA compliant footprint  
58.4mm x 22.8mm x 8.9mm  
(2.30 in x 0.9 in x 0.35 in)
- Ultra wide input voltage range: 18-75 V<sub>dc</sub>
- Tightly regulated output
- Remote sense
- Output Voltage adjust: 90% to 110% of V<sub>O,nom</sub>
- Constant switching frequency
- Positive remote On/Off logic
- Output overcurrent and overvoltage protection
- Overtemperature protection
- Wide operating temperature range (-40°C to 85°C)
- Suitable for cold wall cooling using suitable Gap Pad applied directly to top side of module
- ANSI/UL\* 62368-1 and CAN/CSA† C22.2 No. 62368-1 Recognized, DIN VDE‡ 0868-1/A11:2017 (EN62368-1:2014/A11:2017)
- CE mark meets 2014/35/EU directive§
- Meets the voltage and current requirements for ETSI 300-132- 2 and complies with and licensed for Basic insulation rating
- 2250 Vdc Isolation tested in compliance with IEEE 802.3¶ PoE standards
- ISO\*\*9001 and ISO 14001 certified manufacturing facilities

### FOOTNOTES

\* Trademark of OmniOn Company

# UL is a registered trademark of Underwriters Laboratories, Inc.

† CSA is a registered trademark of Canadian Standards Association.

‡ VDE is a trademark of Verband Deutscher Elektrotechniker e.V.

§ This product is intended for integration into end-user equipment . All of the required procedures of end-use equipment should be followed.

¶ IEEE and 802 are registered trademarks of the Institute of Electrical and Electronics Engineers, Incorporated.

\*\* ISO is a registered trademark of the International Organization of Standards

## Technical Specifications

### Absolute Maximum Ratings

Stresses in excess of the absolute maximum ratings can cause permanent damage to the device. These are absolute stress ratings only, functional operation of the device is not implied at these or any other conditions in excess of those given in the operations sections of the data sheet. Exposure to absolute maximum ratings for extended periods can adversely affect the device reliability.

Parameter	Device	Symbol	Min	Max	Unit
Input Voltage					
Continuous	All	$V_{IN}$	-0.3	80	$V_{dc}$
Transient operational ( $\leq 100ms$ )	All	$V_{IN,trans}$	-0.3	100	$V_{dc}$
Operating Ambient Temperature	All	$T_A$	-40	85	$^{\circ}C$
Maximum Heat Plate Operating Temperature (see Thermal Considerations section)	-18H, H	$T_c$	-40	105	$^{\circ}C$
Storage Temperature	All	$T_{stg}$	-55	125	$^{\circ}C$
Altitude*	All			4000	m
I/O Isolation Voltage (100% factory Hi-Pot tested)	All	-	-	2250	$V_{dc}$

\* For higher altitude applications, contact your OmniOn Sales Representative for alternative conditions of use.

### Electrical Specifications

Unless otherwise indicated, specifications apply over all operating input voltage, resistive load, and temperature conditions.

Parameter	Device	Symbol	Min	Typ	Max	Unit
Operating Input Voltage	All	$V_{IN}$	18	24/48	75	$V_{dc}$
Maximum Input Current ( $V_{IN} = V_{IN, min}$ to $V_{IN, max}$ ; $V_O = V_{O, set}$ ; $I_O = I_{O, max}$ )	All	$I_{IN}$		7.3	7.8	$A_{dc}$
Input No Load Current $V_{IN} = 24V_{dc}$ , ( $I_O = 0$ , module enabled) $V_{IN} = 48V_{dc}$ , ( $I_O = 0$ , module enabled)	All	$I_{IN, No load}$		120 80		mA
Input Stand-by Current ( $V_{IN} = 24$ to $48$ V module disabled)	All	$I_{IN, stand-by}$		5	11	mA
Inrush Transient	All	$I^2t$			0.5	$A^2s$
Input Reflected Ripple Current, peak-to-peak (5Hz to 20MHz, 12 $\mu$ H source impedance; $V_{IN, min}$ to $V_{IN, mix}$ ; $I_O = I_{O, max}$ ; see Test configuration section)	All			30		$mA_{p-p}$
Input Ripple Rejection (120Hz)	All			60		dB

#### CAUTION: This power module is not internally fused. An input line fuse must always be used.

This power module can be used in a wide variety of applications, ranging from simple standalone operation to being part of complex power architecture. To preserve maximum flexibility, internal fusing is not included; however, to achieve maximum safety and system protection, always use an input line fuse. The safety agencies require a fast-acting fuse with a maximum rating of 15A (see Safety Considerations section). Based on the information provided in this data sheet on inrush energy and maximum dc input current, the same type of fuse with a lower rating can be used. Refer to the fuse manufacturer's data sheet for further information.

## Technical Specifications (continued)

### Electrical Specifications (continued)

Unless otherwise indicate, specifications apply at  $V_{IN} = 48V_{dc}$  received load  $T_A = 25^{\circ}C$  condition.

Parameter	Device	Symbol	Min	Typ	Max	Unit
Nominal Output Voltage Set-point $V_{IN} = 24V$ to $48V$ $I_O = I_{O,max}$ , $T_A = 25^{\circ}C$ )	All	$V_{O,set}$	3.25	3.3	3.36	$V_{dc}$
Output Voltage (Over all operating input voltage, resistive load, and temperature conditions until end of life)	All	$V_O$	-3.0	-	+3.0	% $V_{O,set}$
Adjustment Range (* $V_{in} > 20V$ ) Selected by external resistor	All	$V_{O,adj}$	-10		+10*	% $V_{O,set}$
Output Regulation Line ( $V_{IN} = V_{IN,min}$ to $V_{IN,max}$ ) Load ( $I_O = I_{O,min}$ to $I_{O,max}$ ) Temperature ( $T_{ref} = T_{A,min}$ to $T_{A,max}$ )	All All All		- - -	- - -	$\pm 0.2$ $\pm 0.2$ $\pm 1.5$	% $V_{O,set}$ % $V_{O,set}$ % $V_{O,set}$
Output Ripple and Noise on Nominal Output Measured with 10uF Tantalum  1uF ceramic ( $V_{IN} = 24$ to $48$ , $I_O = 80\% I_{O,max}$ , $T_A = 25$ ) RMS (5Hz to 20MHz bandwidth) Peak-to-Peak (5Hz to 20MHz bandwidth)	All All		- -	10 50		$mV_{rms}$ $mV_{pk-pk}$
External Capacitance	All	$C_{O,max}$	0	-	10,000	$\mu F$
Output Current	All	$I_O$	0		36	$A_{dc}$
Output Current Limit Inception (Hiccup Mode ) ( $V_O = 90\%$ of $V_{O,set}$ )	3.3	$I_{O,lim}$	39.6	43		$A_{dc}$
Output Short-Circuit Current ( $V_O \leq 250mV$ ) ( Hiccup Mode )	All	$I_{O,s/c}$		1.2		$A_{rms}$
Efficiency $V_{IN} = 24V$ , $T_A = 25^{\circ}C$ , $I_O = 24A$ , $V_O = 3.3V$ $V_{IN} = 48V$ , $T_A = 25^{\circ}C$ , $I_O = 24A$ , $V_O = 3.3V$	All All	$\eta$ $\eta$		92 91.5		% %
Switching Frequency	All	$f_{sw}$		380		kHz
Dynamic Load Response ( $di_O/dt = 0.1A/\mu s$ ; $V_{IN} = 24V$ or $48V$ ; $T_A = 25^{\circ}C$ ; $C_O > 100\mu F$ ) Load Change from $I_O = 50\%$ to $75\%$ or $25\%$ to $50\%$ of $I_{O,max}$ Peak Deviation Settling Time ( $V_O < 10\%$ peak deviation)	All All	$V_{pk}$ $t_s$	- -	3 800	- -	% $V_{O,set}$ $\mu s$

### Isolation Specifications

Parameter	Device	Symbol	Min	Typ	Max	Unit
Isolation Capacitance	All	$C_{iso}$	-	1000	-	pF
Isolation Resistance	All	$R_{iso}$	10	-	-	M $\Omega$
I/O Isolation Voltage (100% factory Hi-pot tested)	All	All	-	-	2250	$V_{dc}$

## Technical Specifications (continued)

### General Specifications

Parameter	Device	Symbol	Min	Typ	Max	Unit
Calculated Reliability based upon Telcordia SR-332 Issue 2: Method I Case 3 ( $I_O=80\%I_{O,max}$ , $T_A=40^\circ\text{C}$ , airflow = 200 lfm, 90% confidence)	All	FIT	105.7			$10^9$ /Hours
	All	MTBF	9,462,810			Hours
Weight (Open Frame)	All			23(0.8)		g (oz.)
Weight (with Heatplate)	All			37(1.3)		g (oz.)

### Feature Specifications

Unless otherwise indicated, specifications apply over all operating input voltage, resistive load, and temperature conditions. See Feature Descriptions for additional information.

Parameter	Device	Symbol	Min	Typ	Max	Unit
Remote On/Off Signal Interface ( $V_{IN}=V_{IN,min}$ to $V_{IN,max}$ ; open collector or equivalent, Signal referenced to $V_{IN-}$ terminal) Negative Logic: device code suffix "1" Logic Low = module On, Logic High = module Off Positive Logic: No device code suffix required Logic Low = module Off, Logic High = module On Logic Low - Remote On/Off Current Logic Low - On/Off Voltage Logic High Voltage (Typ=Open Collector ) Logic High maximum allowable leakage current	All	$I_{on/off}$	-	-	0.15	mA
	All	$V_{on/off}$	-0.7	-	0.6	$V_{dc}$
	All	$V_{on/off}$	2.5	5	6.7	$V_{dc}$
	All	$I_{on/off}$	-	-	20	$\mu\text{A}$
Turn-On Delay and Rise Times ( $I_O=I_{O,max}$ , $V_{IN}=V_{IN,nom}$ , $T_A=25^\circ\text{C}$ ) Case 1: Input power is applied for at least 1second, and then the On/Off input is set from OFF to ON ( $T_{delay}$ = on/off pin transition until $V_O = 10\%$ of $V_{O,set}$ ) Case 2: On/Off input is set to (Module ON) and then input power is applied ( $T_{delay}$ = from instant at which $V_{IN} = V_{IN}$ until $V_O = 10\%$ of $V_{O,set}$ ) Output voltage Rise time (time for $V_O$ to rise from 10% of $V_{O,set}$ to 90% of $V_{O,set}$ )	All	$T_{delay}$	-	35	-	msec
	All	$T_{delay}$	-	35	-	msec
	All	$T_{rise}$	-	10	-	msec
Output Voltage Overshoot - Startup $I_O=I_{O,max}$ , $V_{IN}=V_{IN,min}$ to $V_{IN,max}$ , $T_A=25^\circ\text{C}$	All			-	3	% $V_{O,set}$
Remote Sense Range	All	$V_{SENSE}$			10	% $V_{O,set}$
Output Overvoltage Protection <sup>1</sup>	All	$V_{O,limt}$	4.0	-	5.5	$V_{dc}$
Overtemperature Protection – Hiccup Auto Restart	Open Frame Heat Plate	$T_{ref}$		135		$^\circ\text{C}$
		$T_{ref}$		120		$^\circ\text{C}$
Input Undervoltage Lockout Turn-on Threshold	All	$V_{UVLO}$	-	17.5		$V_{dc}$
Turn-off Threshold			15	15.5		$V_{dc}$
Hysteresis			1	2		$V_{dc}$
Input Overvoltage Lockout Turn-on Threshold	All	$V_{OVLO}$		79	-	$V_{dc}$
Turn-off Threshold				81		$V_{dc}$
Hysteresis				2		$V_{dc}$

<sup>1</sup> – Module complies with min 100 $\mu\text{F}$  external output cap

# Technical Specifications (continued)

## Characteristic Curves

The following figures provide typical characteristics for the EHHD020A0F (3.3V, 5A) at 25 °C . The figures are identical for either positive or negative remote On/Off logic.

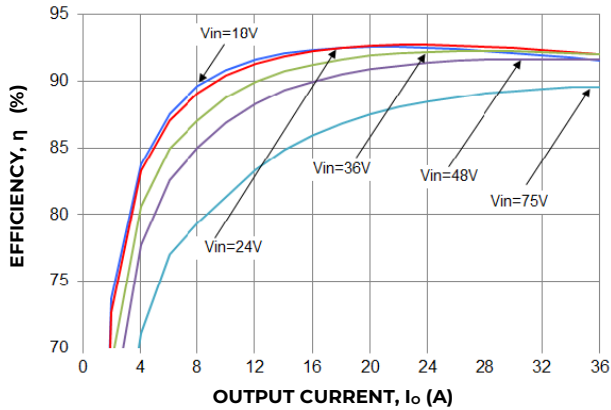

Figure 1. Converter Efficiency versus Output Current.

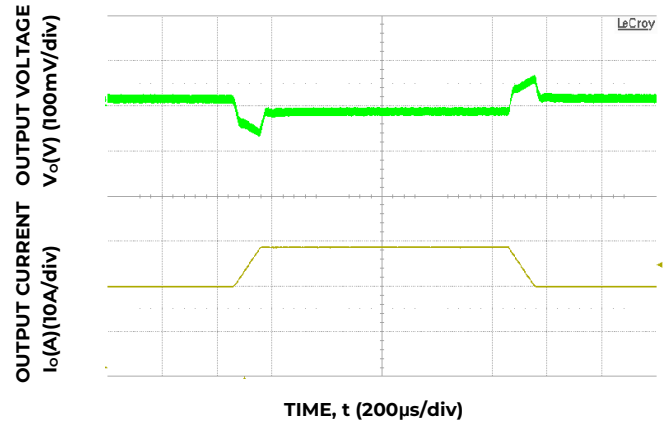

Figure 4. Transient Response to 0.1A/μs Dynamic Load Change from 50% to 75% to 50% of full load,  $V_{in}=48V$

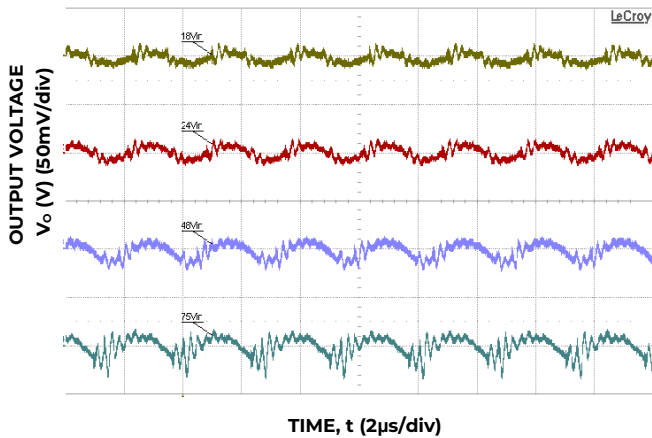

Figure 2. Typical output ripple and noise ( $I_o = I_{o,max}$ ).

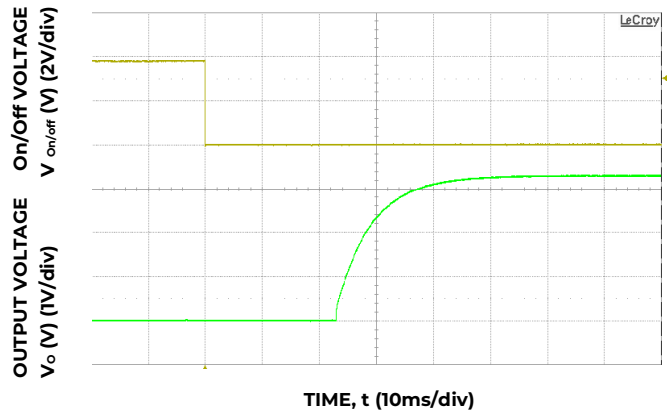

Figure 5. Typical Start-up Using Remote On/Off, negative logic version shown ( $V_{in} = 24V$  or  $48V$ ,  $I_o = I_{o,max}$ )

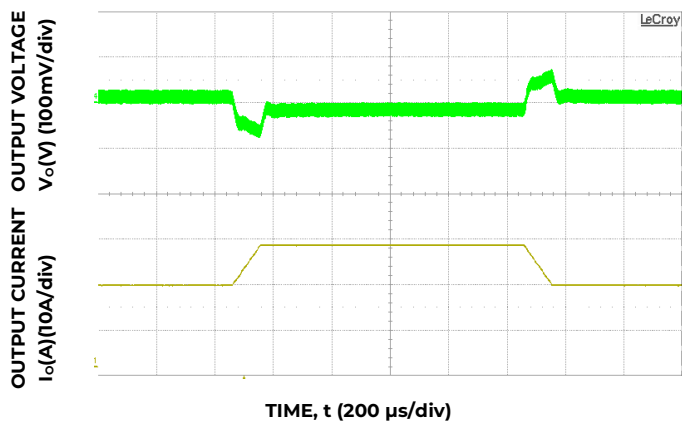

Figure 3. Transient Response to 0.1A/μs Dynamic Load Change from 50% to 75% to 50% of full load,  $V_{in}=24V$

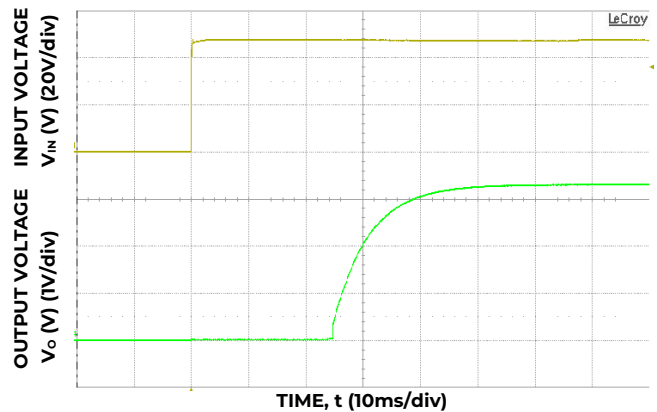
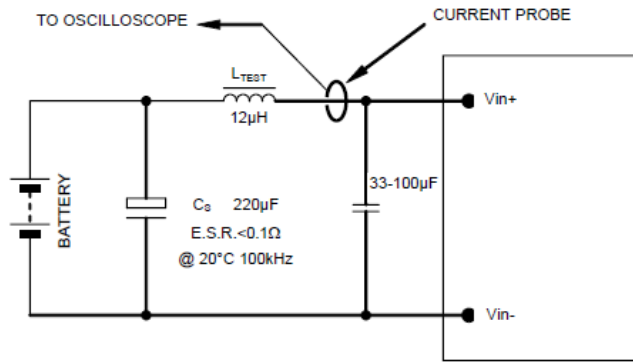

Figure 6. Typical Start-up Using Input Voltage ( $V_{in} = 48V$ ,  $I_o = I_{o,max}$ ).

# Technical Specifications (continued)

## Test Configurations



**Figure 7. Input Reflected Ripple Current Test Setup.**

**NOTE:** Measure input reflected ripple current with a simulated source inductance ( $L_{TEST}$ ) of  $12\mu H$ . Capacitor  $C_S$  offsets possible battery impedance. Measure current as shown above.

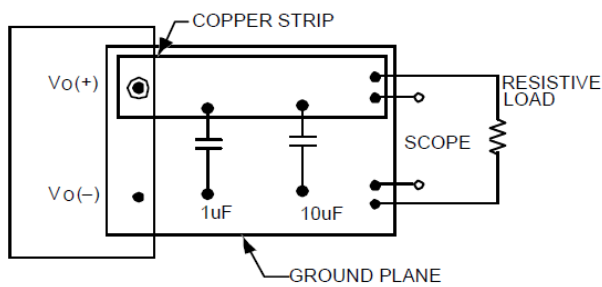

**Figure 8. Output Ripple and Noise Test Setup.**

**NOTE:** All voltage measurements to be taken at the module terminals, as shown above. If sockets are used then Kelvin connections are required at the module terminals to avoid measurement errors due to socket contact resistance.

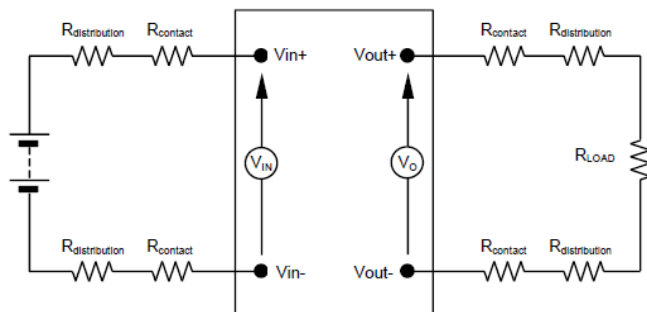

**Figure 9. Output Voltage and Efficiency Test Setup.**

**NOTE:** All voltage measurements to be taken at the module terminals, as shown above. If sockets are used then Kelvin connections are required at the module terminals to avoid measurement errors due to socket contact resistance.

$$\text{Efficiency } \eta = \frac{V_o \cdot I_o}{V_{IN} \cdot I_{IN}} \times 100 \%$$

## Design Considerations

### Input Filtering

The power module should be connected to a low ac-impedance source. Highly inductive source impedance can affect the stability of the power module. For the test configuration in Figure 7 a  $100\mu F$  electrolytic capacitor (ESR  $< 0.7\Omega$  at  $100kHz$ ), mounted close to the power module helps ensure the stability of the unit. Consult the factory for further application guidelines.

### Safety Considerations

For safety agency approval the power module must be installed in compliance with the spacing and separation requirements of the end-use safety agency standards, i.e., UL ANSI/UL\* 62368-1 and CAN/CSA+ C22.2 No. 62368-1 Recognized, DIN VDE 0868-1/ A11:2017 (EN62368-1:2014/A11:2017)

If the input source is non-SELV (ELV or a hazardous voltage greater than 60 Vdc and less than or equal to 75Vdc), for the module's output to be considered as meeting the requirements for safety extra-low voltage (SELV) or ESI, all of the following must be true:

- The input source is to be provided with reinforced insulation from any other hazardous voltages, including the ac mains.
- One  $V_{IN}$  pin and one  $V_{OUT}$  pin are to be grounded, or both the input and output pins are to be kept floating.
- The input pins of the module are not operator accessible.
- Another SELV or ESI reliability test is conducted on the whole system (combination of supply source and subject module), as required by the safety agencies, to verify that under a single fault, hazardous voltages do not appear at the module's output.



## Technical Specifications (continued)

### Safety Considerations (Continued)

**Note:** Do not ground either of the input pins of the module without grounding one of the output pins. This may allow a non-SELV/ES1 voltage to appear between the output pins and ground.

The power module has safety extra-low voltage (SELV) or ES1 outputs when all inputs are SELV or ES1.

All flammable materials used in the manufacturing of these modules are rated 94V-0, or tested to the UN62368-1 for reduced thickness.

For input voltages exceeding  $-60 V_{dc}$  but less than or equal to  $-75 V_{dc}$ , these converters have been evaluated to the applicable requirements of BASIC INSULATION between secondary DC MAINS DISTRIBUTION input (classified as TNV-2 in Europe) and unearthed SELV outputs.

The input to these units is to be provided with a maximum 10A time-delay fuse in the ungrounded lead.

### Feature Descriptions

#### Remote On/Off

Two remote on/off options are available. Positive logic turns the module on during a logic high voltage on the ON/OFF pin, and off during a logic low. Negative logic remote On/Off, device code suffix "1", turns the module off during a logic high and on during a logic low.

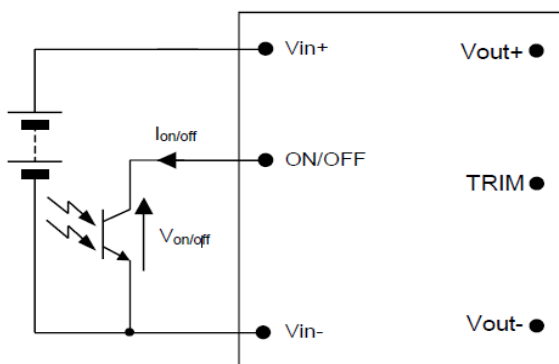

Figure 10 Remote On/Off Implementation.

To turn the power module on and off, the user must supply a switch (open collector or equivalent) to control the voltage ( $V_{on/off}$ ) between the ON/OFF terminal and the  $V_{IN(-)}$  terminal. Logic low is  $0V \leq V_{on/off} \leq 0.6V$ . The maximum  $I_{on/off}$  during a logic low

is 0.15mA; the switch should be maintaining a logic low level while sinking this current.

During a logic high, the typical maximum  $V_{on/off}$  generated by the module is 5V, and the maximum allowable leakage current at  $V_{on/off} = 5V$  is 1 $\mu$ A.

If not using the remote on/off feature:

For positive logic, leave the ON/OFF pin open.

For negative logic, short the ON/OFF pin to  $V_{IN(-)}$ .

#### Remote Sense

Remote sense minimizes the effects of distribution losses by regulating the voltage at the remote-sense connections (See Figure 11). The voltage between the remote-sense pins and the output terminals must not exceed the output voltage sense range given in the Feature Specifications table:

$$[V_{O(+)} - V_{O(-)}] - [SENSE(+)-SENSE(-)] \leq 0.5V$$

Although the output voltage can be increased by both the remote sense and by the trim, the maximum increase for the output voltage is not the sum of both. The maximum increase is the larger of either the remote sense or the trim.

The amount of power delivered by the module is defined as the voltage at the output terminals multiplied by the output current. When using remote sense and trim, the output voltage of the module can be increased, which at the same output current would increase the power output of the module. Care should be taken to ensure that the maximum output power of the module remains at or below the maximum rated power (Maximum rated power =  $V_{o,set} \times I_{o,max}$ ).

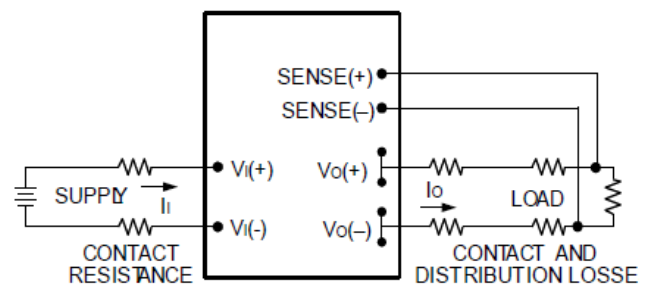

Figure 11. Circuit Configuration for remote sense .

#### Input Undervoltage Lockout

At input voltages below the input undervoltage lockout limit, the module operation is disabled. The module will only begin to operate once the input voltage is raised above the undervoltage lockout turn-on threshold,  $V_{UV/ON}$ .



## Technical Specifications (continued)

### Feature Descriptions (continued)

#### Input Undervoltage Lockout (continued)

Once operating, the module continues to operate until the input voltage is taken below the undervoltage turn-off threshold,  $V_{UV/OFF}$ .

#### Overtemperature Protection

To provide protection under certain fault conditions, the unit is equipped with a thermal shutdown circuit. The unit will shutdown if the thermal reference point,  $T_{ref}$ , exceeds 135°C (Figure 13, typical) or 120°C (Figure 14, typical), but the thermal shutdown is not intended as a guarantee that the unit will survive temperatures beyond its rating. The module will Overtemperature Protection automatically restart upon cool-down to a safe temperature.

#### Output Overvoltage Protection

The output over voltage protection scheme of the modules has an independent over voltage loop to prevent single point of failure. This protection feature latches in the event of over voltage across the output. Cycling the on/off pin or input voltage resets the latching protection feature. If the auto-restart option (4) is ordered, the module will automatically restart upon an internally programmed time elapsing.

#### Overcurrent Protection

To provide protection in a fault (output overload) condition, the unit is equipped with internal current-limiting circuitry and can endure current limiting continuously. At the point of current-limit inception, the unit enters hiccup mode. If the unit is not configured with auto-restart, then it will latch off following the over current condition. The module can be restarted by cycling the dc input power for at least one second or by toggling the remote on/off signal for at least one second.

If the unit is configured with the auto-restart option (4), it will remain in the hiccup mode as long as the overcurrent condition exists; it operates normally, once the output current is brought back into its specified range. The average output current during hiccup is 10%  $I_{o,max}$ .

#### Output Voltage Programming

Trimming allows the output voltage set point to be increased or decreased from the default value; this is accomplished by connecting an external resistor between the TRIM pin and either the  $V_O(+)$  pin or the  $V_O(-)$  pin.

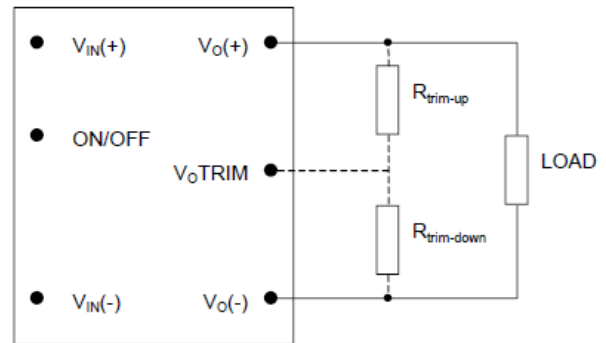

Figure 12. Circuit Configuration to Trim Output Voltage.

Connecting an external resistor ( $R_{trim-down}$ ) between the TRIM pin and the  $V_O(-)$  (or Sense(-)) pin decreases the output voltage set point. To maintain set point accuracy, the trim resistor tolerance should be  $\pm 1.0\%$ . The following equation determines the required external resistor value to obtain a percentage output voltage change of  $\Delta\%$

$$R_{trim-down} = \left[ \frac{511}{\Delta\%} - 10.22 \right] \text{ k}\Omega$$

Where

$$\Delta\% = \left( \frac{3.3V - V_{DESIRED}}{3.3V} \right) \times 100$$

For example, to trim-down the output voltage of the module by 6% to 3.102V,  $R_{trim-down}$  is calculated as follows:

$$\begin{aligned} \Delta\% &= 6 \\ R_{trim-down} &= \left[ \frac{511}{6} - 10.22 \right] \text{ k}\Omega \\ R_{trim-down} &= 74.9 \text{ k}\Omega \end{aligned}$$

Connecting an external resistor ( $R_{trim-up}$ ) between the TRIM pin and the  $V_O(+)$  (or Sense(+)) pin increases the output voltage set point. The following equation determines the required external resistor value to obtain a percentage output voltage change of  $\Delta\%$ :

## Technical Specifications (continued)

### Feature Descriptions (continued)

$$R_{\text{trim-down}} = \left[ \frac{5.11 \times 3.3 \times (100 + \Delta\%)}{1.225 \times \Delta\%} - \frac{511}{\Delta\%} - 10.22 \right] \text{ k}\Omega$$

Where

$$\Delta\% = \left( \frac{V_{\text{desired}} - 3.3}{3.3\text{V}} \right) \times 100$$

For example, to trim-up the output voltage of the module by 4% to 3.432V,  $R_{\text{trim-up}}$  is calculated as follows:

$$R_{\text{trim-down}} = \left[ \frac{511 \times 3.3 \times (100 + 4)}{1.225 \times 4} - \frac{511}{4} - 10.22 \right] \text{ k}\Omega$$

$$R_{\text{trim-down}} = 219.9 \text{ k}\Omega$$

The voltage between the  $V_O(+)$  and  $V_O(-)$  terminals must not exceed the minimum output overvoltage protection value shown in the Feature Specifications table. This limit includes any increase in voltage due to remote-sense compensation and output voltage set-point adjustment trim.

Although the output voltage can be increased by both the remote sense and by the trim, the maximum increase for the output voltage is not the sum of both. The maximum increase is the larger of either the remote sense or the trim. The amount of power delivered by the module is defined as the voltage at the output terminals multiplied by the output current. When using remote sense and trim, the output voltage of the module can be increased, which at the same output current would increase the power output of the module. Care should be taken to ensure that the maximum output power of the module remains at or below the maximum rated power (Maximum rated power =  $V_{O,\text{set}} \times I_{O,\text{max}}$ ).

### Thermal Considerations

The power modules operate in a variety of thermal environments; however, sufficient cooling should be provided to help ensure reliable operation.

Considerations include ambient temperature, airflow, module power dissipation, and the need for increased reliability. A reduction in the operating temperature of the module will result in an increase in reliability.

The thermal data presented here is based on physical measurements taken in a wind tunnel, using automated thermo-couple instrumentation to monitor key component temperatures: FETs, diodes, control ICs, magnetic cores, ceramic capacitors, opto-isolators, and module pwb conductors, while controlling the ambient airflow rate and temperature. For a given airflow and ambient temperature, the module output power is increased, until one (or more) of the components reaches its maximum derated operating temperature, as defined in IPC-9592. This procedure is then repeated for a different airflow or ambient temperature until a family of module output derating curves is obtained.

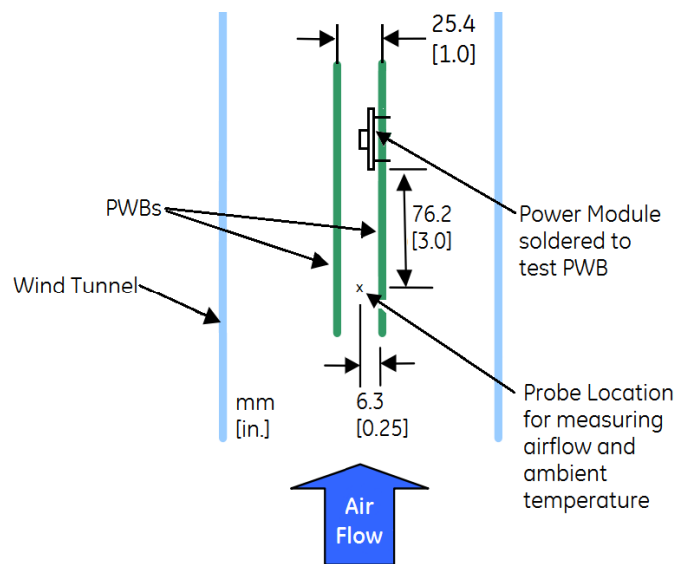

The thermal reference point,  $T_{\text{ref1}}$  and  $T_{\text{ref2}}$  used in the specifications for open frame module is shown in Figure 13. For reliable operation this temperature should not exceed 122°C and 123°C

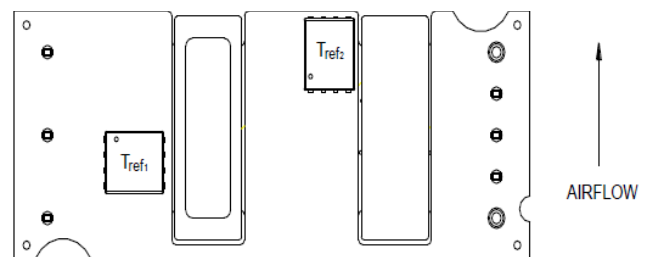
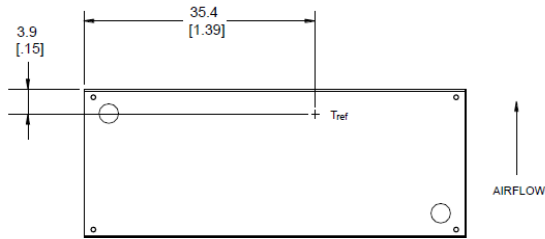

**Figure 13. Tref Temperature Measurement Locations for Open Frame Module.**

The thermal reference point,  $T_{\text{ref}}$ , used in the specifications for modules with heatplate is shown in Figure 14. For reliable operation this temperature should not exceed 100°C.

# Technical Specifications (continued)

## Thermal Considerations (continued)

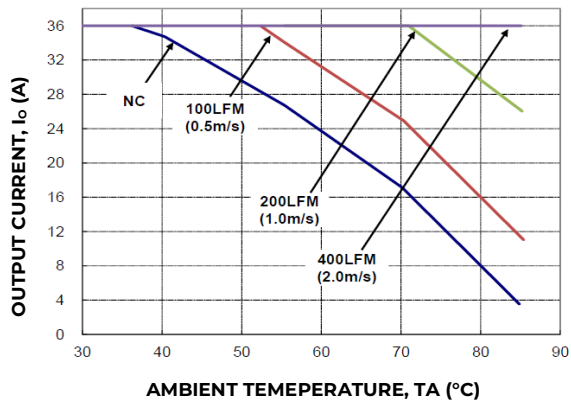

**Figure 14. Tref Temperature Measurement Location for Module with Heatplate.**

### Heat Transfer via Convection

Increased airflow over the module enhances the heat transfer via convection. Derating curves showing the maximum output current that can be delivered by each module versus local ambient temperature ( $T_A$ ) for natural convection and up to 3m/s (600 ft./min) forced airflow are shown in Figures 15 - 20.

Please refer to the Application Note “Thermal Characterization Process For Open-Frame Board-Mounted Power Modules” for a detailed discussion of thermal aspects including maximum device temperatures.



**Figure 15. Output Current Derating for the Open Frame Module; Airflow in the Transverse Direction from  $V_{out(-)}$  to  $V_{out(+)}$ ;  $V_{IN} = 48V$ ,  $V_o = 3.3V$ .**

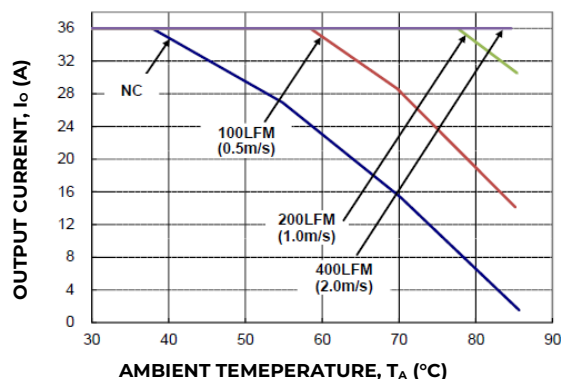

**Figure 16. Output Current Derating for the Module with Heatplate; Airflow in the Transverse Direction from  $V_{out(-)}$  to  $V_{out(+)}$ ;  $V_{IN} = 48V$ ,  $V_o = 3.3V$ .**

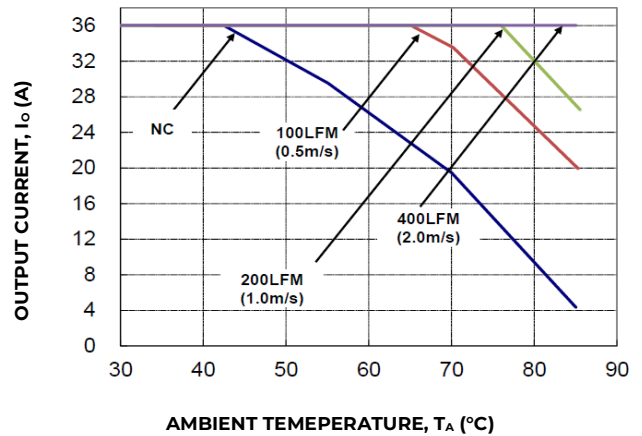

**Figure 17. Output Current Derating for the Module with 18H Heatplate; Airflow in the Transverse Direction from  $V_{out(-)}$  to  $V_{out(+)}$ ;  $V_{IN} = 48V$ ,  $V_o = 3.3V$ .**

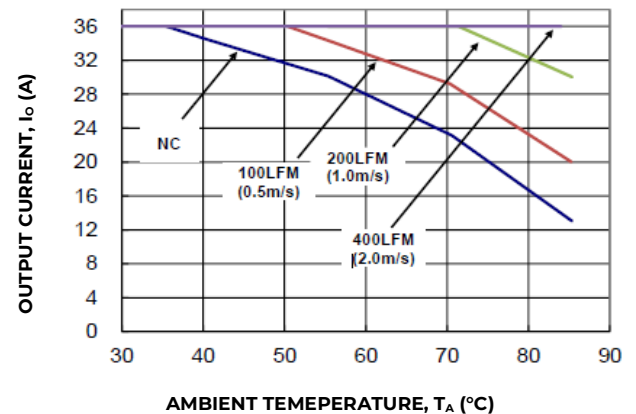

**Figure 18. Output Current Derating for the Open Frame Module; Airflow in the Transverse Direction from  $V_{out(-)}$  to  $V_{out(+)}$ ;  $V_{IN} = 24V$ ,  $V_o = 3.3V$ .**

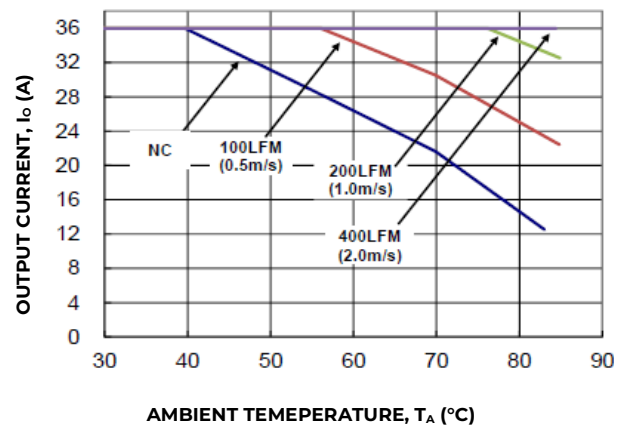

**Figure 19. Output Current Derating for the Module with Heatplate; Airflow in the Transverse Direction from  $V_{out(-)}$  to  $V_{out(+)}$ ;  $V_{IN} = 24V$ ,  $V_o = 3.3V$ .**

## Technical Specifications (continued)

### Thermal Considerations (continued)

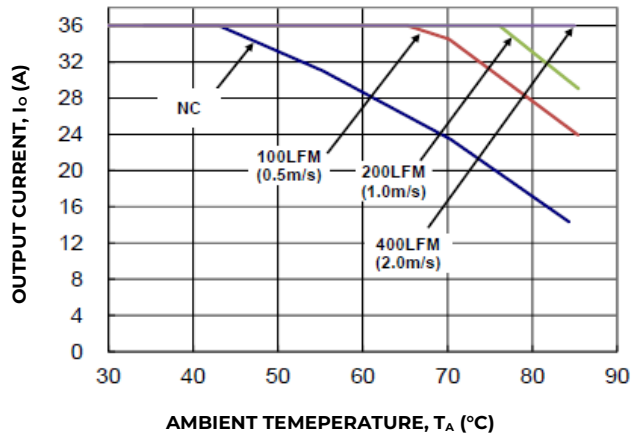

**Figure 20. Output Current Derating for the Module with—18 Heatplate; Airflow in the Transverse Direction from  $V_{out(-)}$  to  $V_{out(+)}$ ;  $V_{IN} = 24V$ ,  $V_O = 3.3V$ .**

#### Heat Transfer via Conduction

The module can also be used in a sealed environment with cooling via conduction from the module's top surface through a gap pad material to a cold wall, as shown in Figure 21. This capability is achieved by insuring the top side component skyline profile achieves no more than 1mm height difference between the tallest and the shortest power train part that benefits from contact with the gap pad material. The output current derating versus cold wall temperature, when using a gap pad such as Bergquist GP2500S20, is shown in Figure 22

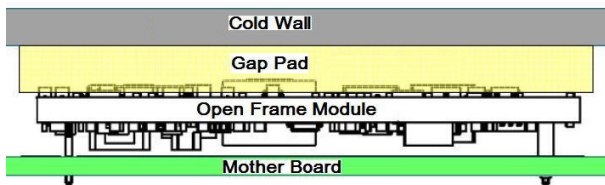

**Figure 21. Cold Wall Mounting**

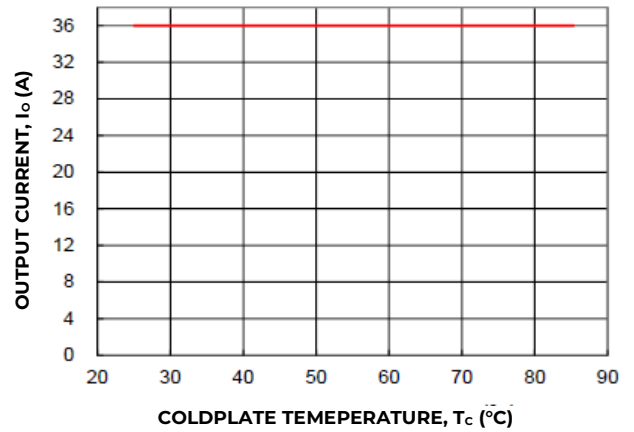

**Figure 22. Derated Output Current versus Cold Wall Temperature with local ambient temperature around module at 85°C;  $V_{IN} = 24V$  or 48V.**

### Through-Hole Soldering Information

#### Lead-Free Soldering

The EHHD036A0Fxx RoHS-compliant through-hole products use SAC (Sn/Ag/Cu) Pb-free solder and RoHS-compliant components. They are designed to be processed through single or dual wave soldering machines. The pins have a RoHS-compliant finish that is compatible with both Pb and Pb-free wave soldering processes. A maximum preheat rate of 3°C/s is suggested. The wave preheat process should be such that the temperature of the power module board is kept below 210°C. For Pb solder, the recommended pot temperature is 260°C, while the Pb-free solder pot is 270°C max.

#### Paste-in-Hole Soldering

The EHHD036A0Fxx module is compatible with reflow paste-in-hole soldering processes shown in Figures 24-26. Since the EHHD036A0FxxZ module is not packaged per J-STD-033 Rev.A, the module must be baked prior to the paste-in-hole reflow process. Please contact your OmniOn Sales Representative for further information.

#### Pick and Place

The EHHD036A0A modules use an open frame construction and are designed for a fully automated assembly process. The modules are fitted with a label designed to provide a large surface area for pick and place operations. The label meets all the requirements for surface mount processing, as well as safety standards, and is able to withstand reflow temperatures of up to 300°C. The label also carries product information such as product code, serial number and the location of manufacture.

## Technical Specifications (continued)

### Through-Hole Soldering Information (continued)

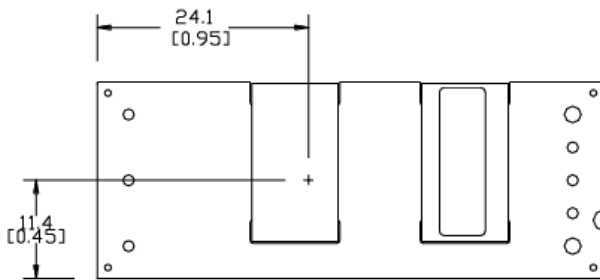

Figure 23. Pick and Place Location.

### Nozzle Recommendations

The module weight has been kept to a minimum by using open frame construction. Even so, these modules have a relatively large mass when compared to conventional SMT components. Variables such as nozzle size, tip style, vacuum pressure and placement speed should be considered to optimize this process. The minimum recommended nozzle diameter for reliable operation is 6mm. The maximum nozzle outer diameter, which will safely fit within the allowable component spacing, is 9 mm.

Oblong or oval nozzles up to 11 x 9 mm may also be used within the space available.

### Tin Lead Soldering

The EHHD036A0F power modules are lead free modules and can be soldered either in a lead-free solder process or in a conventional Tin/Lead (Sn/Pb) process. It is recommended that the customer review data sheets in order to customize the solder reflow profile for each application board assembly. The following instructions must be observed when soldering these units. Failure to observe these instructions may result in the failure of or cause damage to the modules, and can adversely affect long-term reliability.

In a conventional Tin/Lead (Sn/Pb) solder process peak reflow temperatures are limited to less than 235°C. Typically, the eutectic solder melts at 183°C, wets the land, and subsequently wicks the device connection. Sufficient time must be allowed to fuse the plating on the connection to ensure a reliable solder joint. There are several types of SMT reflow technologies currently

used in the industry. These power modules can be reliably soldered using natural forced convection, IR (radiant infrared), or a combination of convection/IR. For reliable soldering the solder reflow profile should be established by accurately measuring the modules CP connector temperatures.

### Lead Free Soldering

The -Z version of the EHHD024A0A modules are lead-free (Pb-free) and RoHS compliant and are both forward and backward compatible in a Pb-free and a SnPb soldering process. Failure to observe the instructions below may result in the failure of or cause damage to the modules and can adversely affect long-term reliability.

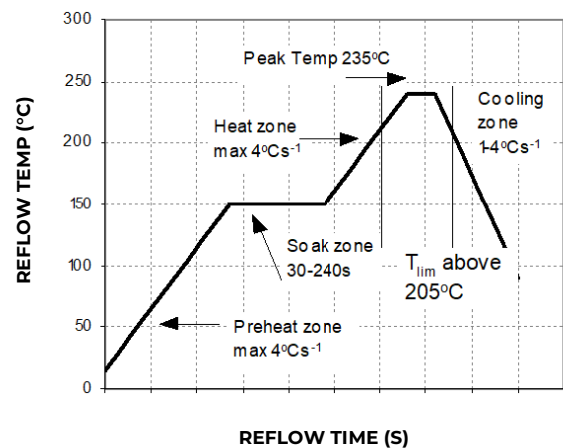

Figure 24. Reflow Profile for Tin/Lead (Sn/Pb) process.

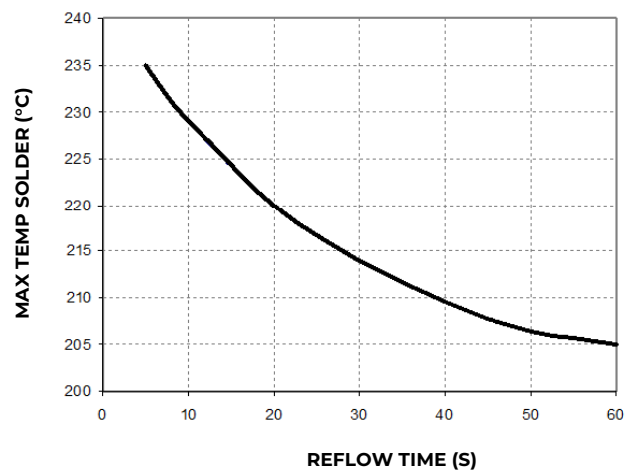

Figure 25. Time Limit Curve Above 205°C for Tin/Lead (Sn/Pb) process

## Technical Specifications (continued)

### Through-Hole Soldering Information (continued)

#### Pb-free Reflow Profile

Power Systems will comply with J-STD-015 Rev. C (Moisture/Reflow Sensitivity Classification for Nonhermetic Solid State Surface Mount Devices) for both Pb-free solder profiles and MSL classification procedures. This standard provides a recommended forced-air-convection reflow profile based on the volume and thickness of the package (table 4-2). The suggested Pb-free solder paste is Sn/Ag/Cu (SAC). The recommended linear reflow profile using Sn/Ag/Cu solder is shown in Figure 26.

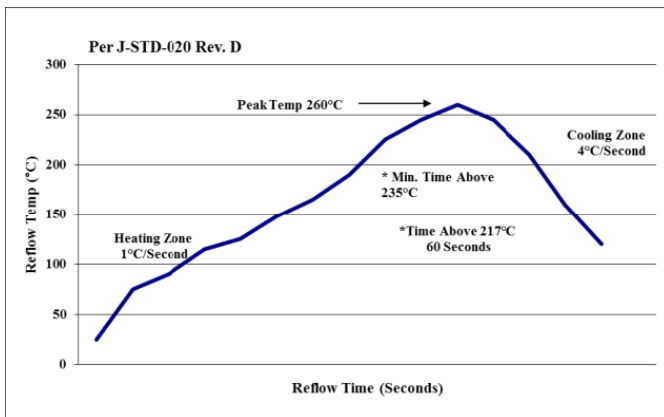

**Figure 26. Recommended linear reflow profile using Sn/Ag/Cu solder.**

#### Post Solder Cleaning and Drying Considerations

Post solder cleaning is usually the final circuit-board assembly process prior to electrical board testing. The result of inadequate cleaning and drying can affect both the reliability of a power module and the testability of the finished circuit-board assembly. For guidance on appropriate soldering, cleaning and drying procedures, refer to OmniOn Board Mounted Power Modules: Soldering and Cleaning Application Note (AN04-001).

# Technical Specifications (continued)

## EMC Considerations

The circuit and plots in Figure 27 shows a suggested configuration to meet the conducted emission limits of EN55032 Class B.

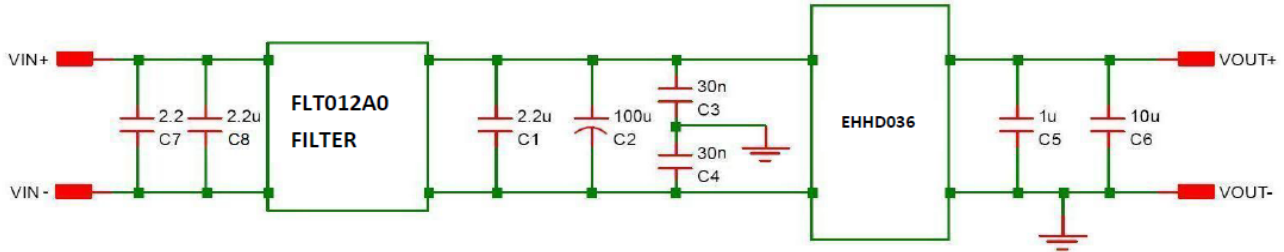

Figure 27. EMC Considerations

For further information on designing for EMC compliance, please refer to the FLT0012A0 data sheet

Detector: PK+AV      Test-time(ms): 20  
 Limit: EN55022B      Transducer: 4  
 Remark:

Start(MHz)	End(MHz)	Step(MHz)	freq, step
0.150	0.400	0.002	
0.400	1.000	0.005	
1.000	5.000	0.005	
5.000	10.000	0.010	
10.000	30.000	0.050	

scan result

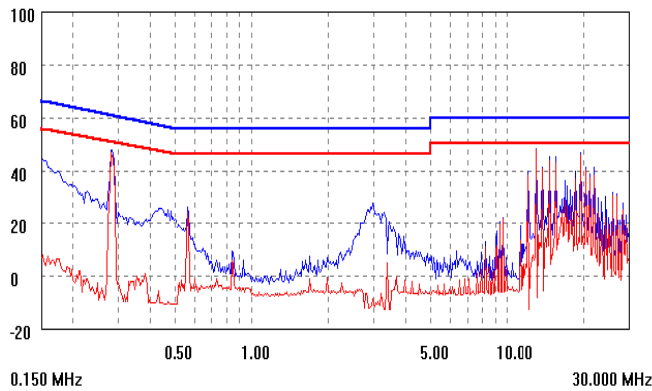

V<sub>IN</sub> = 48V, I<sub>o</sub> = I<sub>o,max</sub>, L Line

Detector: PK+AV      Test-time(ms): 20  
 Limit: EN55022B      Transducer: 4  
 Remark:

Start(MHz)	End(MHz)	Step(MHz)	freq, step
0.150	0.400	0.002	
0.400	1.000	0.005	
1.000	5.000	0.005	
5.000	10.000	0.010	
10.000	30.000	0.050	

scan result

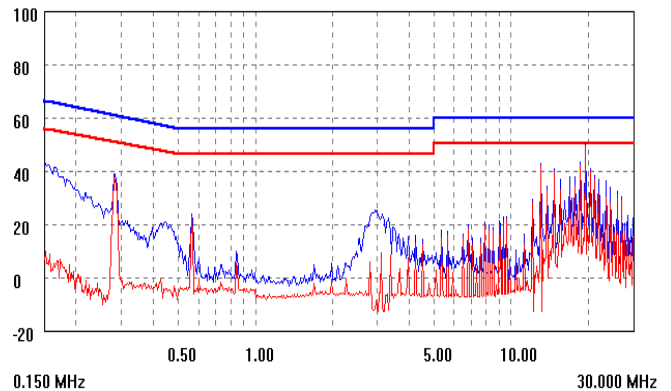

V<sub>IN</sub> = 48V, I<sub>o</sub> = I<sub>o,max</sub>, N Line



## Technical Specifications (continued)

### Mechanical Outline for Through-Hole Module

Dimensions are in millimeters and [inches].

Tolerances: x.x mm  $\pm 0.5$  mm [x.xx in.  $\pm 0.02$  in.] (Unless otherwise indicated)

x.xx mm  $\pm 0.25$  mm [x.xxx in.  $\pm 0.010$  in.]

\*Top side label includes OmniOn name, product designation and date code.

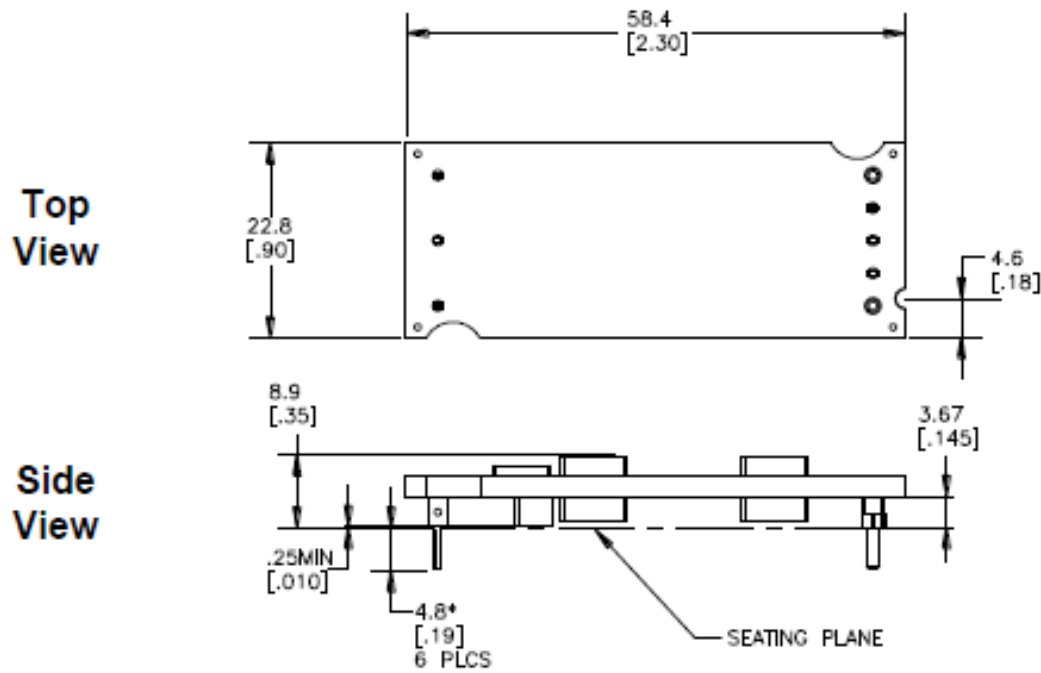

\*For optional pin lengths, see Table 2, Device Coding Scheme and Options

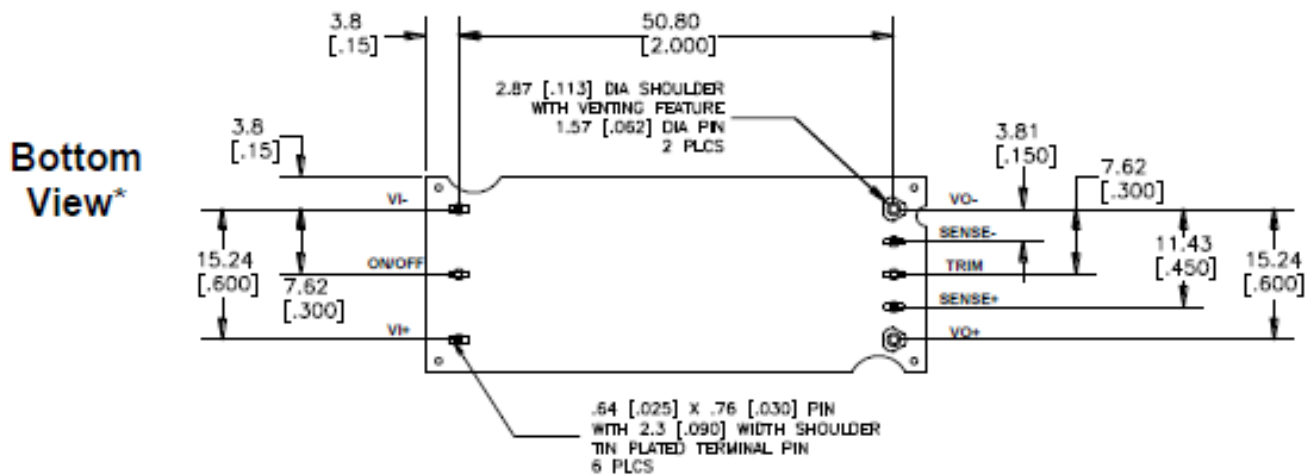

## Technical Specifications (continued)

### Mechanical Outline for Through-Hole Module with Heat Plate (-H Option)

Dimensions are in millimeters and [inches].

Tolerances: x.x mm ± 0.5 mm [x.xx in. ± 0.02 in.] (Unless otherwise indicated)

x.xx mm ± 0.25 mm [x.xxx in. ± 0.010 in.]

**Top View**

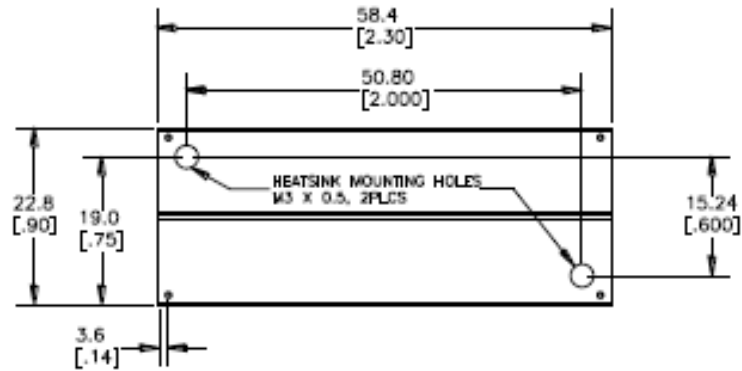

**Side View**

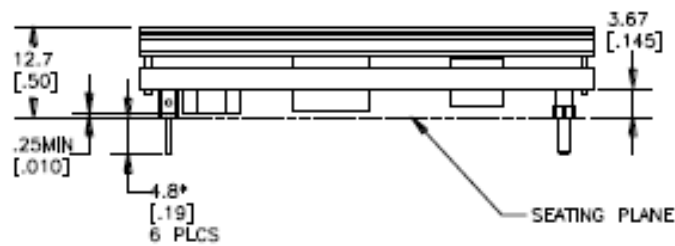

\*For optional pin lengths, see Table 2, Device Coding Scheme and Options

**Bottom View\***

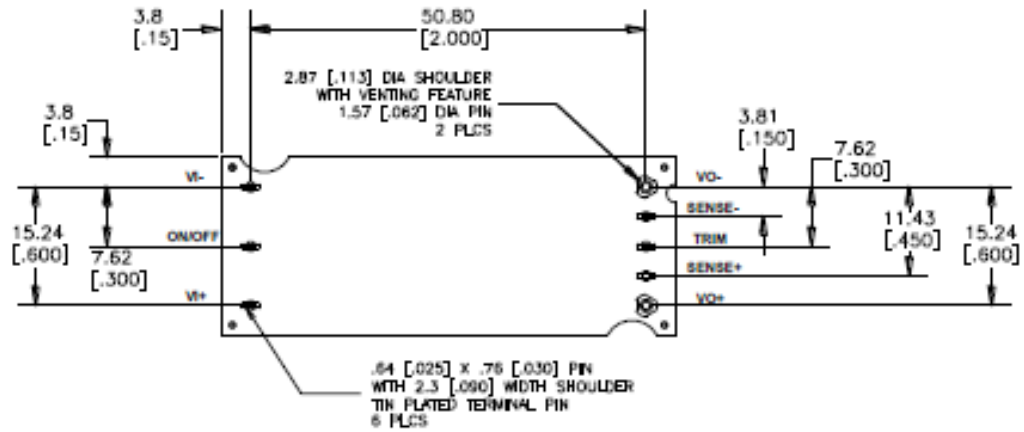

\*Bottom side label includes product designation and date code.

**\*\*Side View**

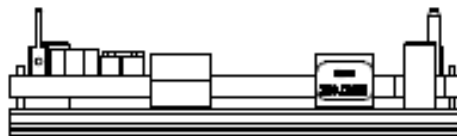

\*\*Side label contains product designation and date code.

## Technical Specifications (continued)

### Mechanical Outline for Through-Hole Module with ¼ Brick Heat Plate (-18H Option)

Dimensions are in millimeters and [inches].

Tolerances: x.x mm ± 0.5 mm [x.xx in. ± 0.02 in.] (Unless otherwise indicated)

x.xx mm ± 0.25 mm [x.xxx in. ± 0.010 in.]

Top View

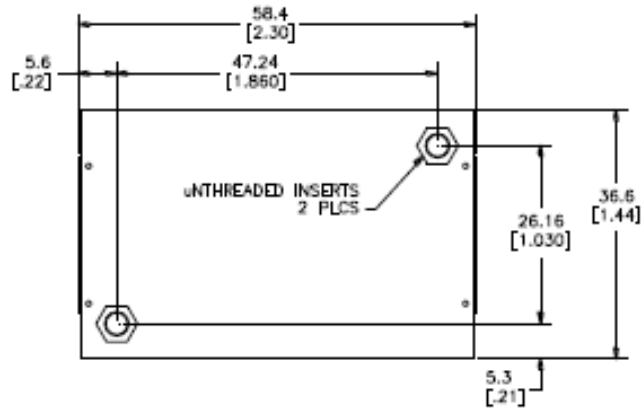

Side View

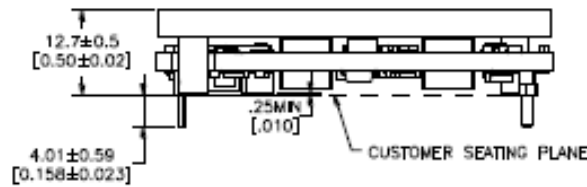

\*For optional pin lengths, see Table 2, Device Coding Scheme and Options

Bottom View\*

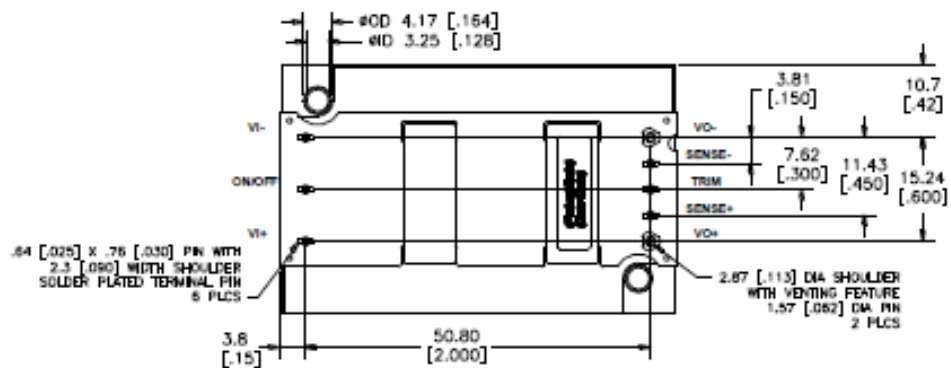

\*\*Side View

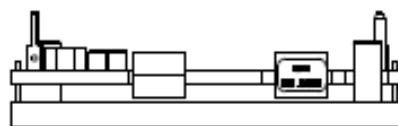

\*\*Side label contains product designation and date code.

## Technical Specifications (continued)

### Recommended Pad Layout

Dimensions are in millimeters and [inches].

Tolerances: x.x mm  $\pm$  0.5 mm [x.xx in.  $\pm$  0.02 in.] (Unless otherwise indicated)

x.xx mm  $\pm$  0.25 mm [x.xxx in.  $\pm$  0.010 in.]

Pin	Function
1	Vi(+)
2	ON/OFF
3	vi(-)
4	Vo(-)
5	SENSE(-)
6	TRIM
7	SENSE(+)
8	Vo(+)

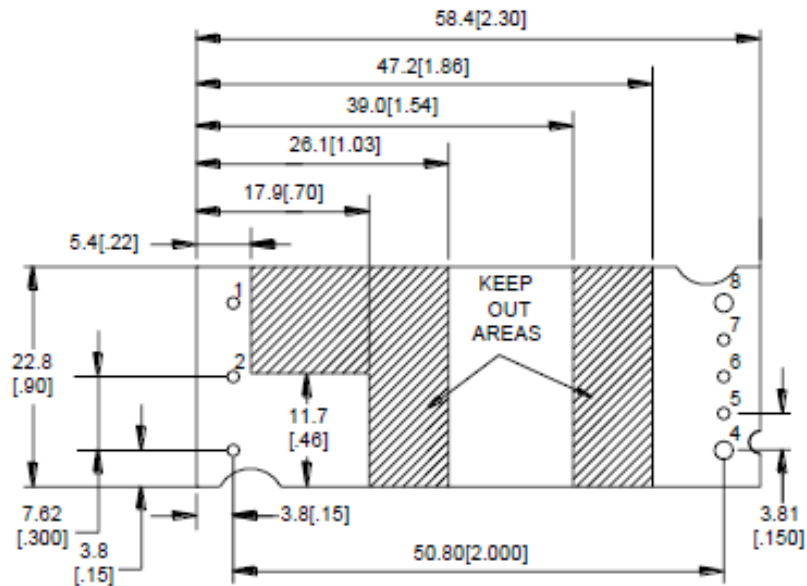

TH Recommended Pad Layout (Component Side View)

#### NOTES:

FOR 0.030" X 0.025" RECTANGULAR PIN, USE 0.063" PLATED THROUGH HOLE DIAMETER

FOR 0.62 DIA" PIN, USE 0.087" PLATED THROUGH HOLE DIAMETER

## Technical Specifications (continued)

### Ordering Information

Please contact your OmniOn Sales Representative for pricing, availability and optional features.

Product Code	Input Voltage	Output Voltage	Output Current	On/Off Logic	Connector Type	Ordering Code
EHHD036A0F 41Z	24V/48V (18-75V <sub>dc</sub> )	3.3V	36A	Negative	Through hole	150029666
EHHD036A0F 41-HZ	24V/48V (18-75V <sub>dc</sub> )	3.3V	36A	Negative	Through hole	150029824
EHHD036A0F 41-18HZ	24V/48V (18-75V <sub>dc</sub> )	3.3V	36A	Negative	Through hole	150029826

Table 1. Device Codes

	Characteristic	Character and Position										Definition		
Ratings	Form Factor	E											E = 1/8 Brick	
	Family Designator	H	H										HH = Hammerhead™ Series	
	Input Voltage		D										D = Ultra Wide Range, 18V-75V	
	Output Current			036A	0								036A0 = 036.0 Amps Maximum Output Current	
	Output Voltage					F							F=3.3V nominal	
Options	Pin Length						6	8					Omit = Default Pin Length shown in Mechanical Outline Figures 6 = Pin Length: 3.68 mm ± 0.25mm , (0.145 in. ± 0.010 in.) 8 = Pin Length: 2.79 mm ± 0.25mm , (0.110 in. ± 0.010 in.)	
	Action following Protective Shutdown							4					Omit = Latching Mode 4 = Auto restart following shutdown (overcurrent/ overvoltage) Must be ordered	
	On/Off Logic								1				Omit = Positive Logic 1 = Negative Logic	
	Customer Specific										X	Y	XY= Customer Specific Modified Code, Omit for Standard Code	
	Mechanical Features												H	Omit = Standard open Frame Module H= 1/8th Brick size heat plate, for use with heat sinks (not available with -S option)
													18H	18H= 1/4th Brick size heat plate with unthreaded inserts for use in coldwall applications (not available with -S option)
	RoHS													Omit = RoHS 5/6, Lead Based Solder Used Z = RoHS Compliant

Table 2. Device Coding Scheme and Options

### Contact Us

For more information, call us at

1-877-546-3243 (US)

1-972-244-9288 (Int'l)

## Change History (excludes grammar & clarifications)

Revision	Date	Description of the change
1.7	04/08/2022	Updated ROHS
1.8	12/14/2023	Updated as per OmniOn template

**OmniOn Power Inc.**

601 Shiloh Rd.  
Plano, TX USA

[omnionpower.com](http://omnionpower.com)

We reserve the right to make technical changes or modify the contents of this document without prior notice. OmniOn Power does not accept any responsibility for errors or lack of information in this document and makes no warranty with respect to and assumes no liability as a result of any use of information in this document.

We reserve all rights in this document and in the subject matter and illustrations contained therein. Any reproduction, disclosure to third parties or utilization of its contents – in whole or in parts – is forbidden without prior written consent of OmniOn Power. This document does not convey license to any patent or any intellectual property right. Copyright© 2023 OmniOn Power Inc. All rights reserved.