

# EBVW017A0S14R0 Barracuda\* Series DC-DC Converter Power Modules

**36-75V<sub>dc</sub> Input; 14.0V<sub>dc</sub> Output; 17A Output Current**

RoHS Compliant

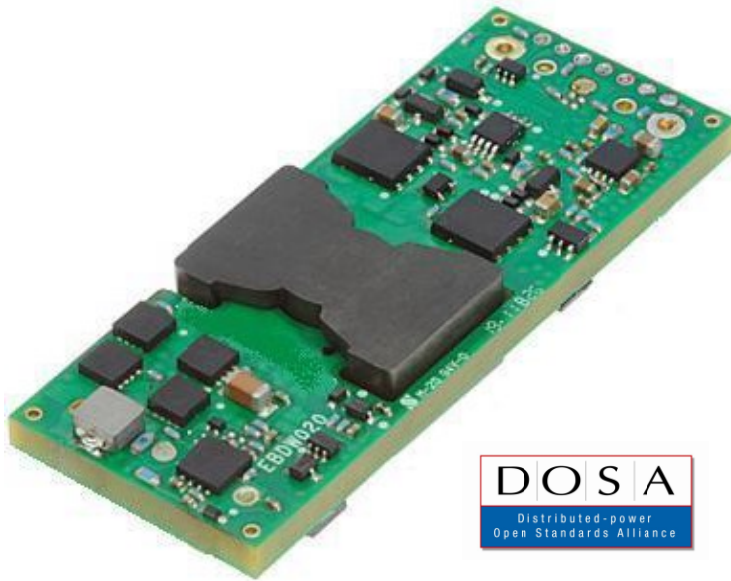

## Description

The EBVW017A0S14R0 series of dc-dc converters are a new generation of DC/DC power modules designed to support 14.0V<sub>dc</sub> DSL applications, as distributed power architectures. The EBVW017A0S14R0 series operate from an input voltage range of 36 to 75V<sub>dc</sub>, and provide up to 17A output current at 14.0V<sub>dc</sub> output voltage, and 240W output power in a DOSA standard eighth brick. The converter incorporates digital control, synchronous rectification technology, and innovative packaging techniques to achieve efficiency reaching 95.5% peak at 14.0V<sub>dc</sub> output. This leads to lower power dissipations such that for many applications a heat sink is not required. Standard features

include on/off control, output overcurrent and over voltage protection, over temperature protection, input under and over voltage lockout. Optional features include a base plate for heat sink or cold wall applications.

The output is fully isolated from the input, allowing versatile polarity configurations and grounding connections. Built-in filtering for both input and output minimizes the need for external filtering.

## Applications

- Distributed Power Architectures
- Intermediate bus voltage applications
- DSL systems

## Options

- Negative Remote On/Off logic (1=option code, factory preferred)
- Auto-restart after fault shutdown (4=option code, factory preferred)
- Base plate option (-H=option code)

See Footnote on Page No. 2

## Features

- Compliant to RoHS EU Directive 2011/65/EC and amended Directive (EU) 2015/863. (-Z versions)
- Compliant to REACH Directive (EC) No 1907/2006
- Compatible with reflow pin/paste soldering process
- High and flat efficiency profile – 95.4% at 14.0V<sub>dc</sub>, 55% load to 90% output
- Wide Input voltage range: 36-75V<sub>dc</sub>
- Delivers up to 17A<sub>dc</sub> output current
- Tightly regulated output voltage
- Low output ripple and noise
- No reverse current during prebias start-up or shut-down
- Industry standard, DOSA compliant, Eight brick: 58.4 mm x 22.8 mm x 11.3 mm (2.30 in x 0.90 in x 0.44 in)
- Constant switching frequency
- Positive Remote On/Off logic
- Output over current/voltage protection
- Over temperature protection
- Wide operating temperature range (-40°C to 85°C)
- ANSI/UL\* 62368-1 and CAN/CSA† C22.2 No. 62368-1 Recognized, DIN VDE‡ 0868-1/A11:2017 (EN62368-1:2014/A11:2017)
- CE mark 2006/96/EC directives<sup>§</sup>
- Meets the voltage and current requirements for ETSI 300-132-2 and complies with and licensed for Basic insulation
- 2250 V<sub>dc</sub> Isolation tested in compliance with IEEE 802.3<sup>¶</sup> PoE standards
- ISO\*\* 9001 and ISO14001 certified manufacturing facilities

### FOOTNOTES

\*Trademark of OmniOn Company

# UL is a registered trademark of Underwriters Laboratories, Inc.

† CSA is a registered trademark of Canadian Standards Association.

‡ VDE is a trademark of Verband Deutscher Elektrotechniker e.V.

§ This product is intended for integration into end-user equipment. All of the required procedures of end-use equipment should be followed.

¶ IEEE and 802 are registered trademarks of the Institute of Electrical and Electronics Engineers, Incorporated.

\*\* ISO is a registered trademark of the International Organization of Standards

## Technical Specifications

### Absolute Maximum Ratings

Stresses in excess of the absolute maximum ratings can cause permanent damage to the device. These are absolute stress ratings only, functional operation of the device is not implied at these or any other conditions in excess of those given in the operations sections of the data sheet. Exposure to absolute maximum ratings for extended periods can adversely affect the device reliability.

Parameter	Device	Symbol	Min	Max	Unit
Input Voltage*					
Continuous		$V_{IN}$	-0.3	75	$V_{dc}$
Operating transient $\leq 100\text{mS}$				100	$V_{dc}$
Operating Input transient slew rate, $50V_{IN}$ to $75V_{IN}$ (Output may exceed regulation limits, no protective shutdowns shall activate, $C_O=220\mu\text{F}$ to		-	-	10	$\text{V}/\mu\text{s}$
Non- operating continuous		$V_{IN}$	80	100	$V_{dc}$
Operating Ambient Temperature (See Thermal Considerations section)	All	TA	-40	85	$^{\circ}\text{C}$
Storage Temperature	All	Tstg	-55	125	$^{\circ}\text{C}$
I/O Isolation Voltage (100% factory Hi-Pot tested)	All	-	-	2250	$V_{dc}$

\* Input over voltage protection will shutdown the output voltage, when the input voltage exceeds threshold level.

### Electrical Specifications

Unless otherwise indicated, specifications apply over all operating input voltage, resistive load, and temperature conditions.

Parameter	Device	Symbol	Min	Typ	Max	Unit
Operating Input Voltage	All	$V_{IN}$	36	48	75	$V_{dc}$
Maximum Input Current ( $V_{IN}=0\text{V}$ to $75$ , $I_O=I_{O,max}$ )	All	$I_{IN,max}$	-	-	7	$A_{dc}$
Input No Load Current $V_{IN} = 48V_{dc}$ , ( $I_O = 0$ , module enabled)	All	$I_{IN,No\ load}$		50		mA
Input Stand-by Current ( $V_{IN} = 48V_{dc}$ , module disabled)	All	$I_{IN,stand-by}$			25	mA
External Input Capacitance	All		100	-	-	$\mu\text{F}$
Inrush Transient	All	$I^2t$	-	-	1	$A^2s$
Input Terminal Ripple Current (Measured at module input pin with maximum specified input capacitance and $< 500\mu\text{H}$ inductance between voltage source and input capacitance $C_{IN}=220\mu\text{F}$ , 5Hz to	All		-	900	-	$\text{mA}_{p-p}$
Input Reflected Ripple Current, peak-to-peak (5Hz to 20MHz, $12\mu\text{H}$ source impedance; $V_{IN}=48\text{V}$ , $I_O = I_{O,max}$ ; see Figure 12)			-	24	-	$\text{mA}_{p-p}$
Input Ripple Rejection (120Hz)	All		-	50	-	dB

## Technical Specifications (continued)

### Electrical Specifications (continued)

**CAUTION: This power module is not internally fused. An input line fuse must always be used.**

This power module can be used in a wide variety of applications, ranging from simple standalone operation to being part of complex power architecture. To preserve maximum flexibility, internal fusing is not included; however, to achieve maximum safety and system protection, always use an input line fuse. The safety agencies require a fast-acting fuse with a maximum rating of 10A (see Safety Considerations section). Based on the information provided in this data sheet on inrush energy and maximum dc input current, the same type of fuse with a lower rating can be used. Refer to the fuse manufacturer's data sheet for further information.

Parameter	Device	Symbol	Min	Typ	Max	Unit
Output Voltage Set-point ( $V_{IN}=24V$ to $48V$ $I_O=I_{O,max}$ , $T_A=25^\circ C$ )	All	$V_{O,set}$	13.97	14.00	14.03	$V_{dc}$
Output Voltage (Over all operating input voltage, resistive load, and temperature)	All	$V_O$	13.71	-	14.29	$V_{dc}$
Output Voltage ( $V_{IN}=36V$ , $T_A=25^\circ C$ )	All	$V_O$	10.8	-	-	$V_{dc}$
Output Regulation ( $V_{IN,min}=46V$ )	All		-	0.2	-	% $V_{O,set}$
Line ( $V_{IN}=V_{IN,min}$ to $V_{IN,max}$ )	All		-	0.2	-	% $V_{O,set}$
Load ( $I_O=I_{O,min}$ to $I_{O,max}$ )	All		-	2	-	% $V_{O,set}$
Temperature ( $T_A=-40^\circ C$ to $+85^\circ C$ )						
Output Ripple and Noise on nominal output ( $V_{IN}=V_{IN,nom}$ and $I_O=I_{O,min}$ to $I_{O,max}$ , tested with a $1.0\ \mu F$ ceramic, $10\ \mu F$ aluminum and $220\ \mu F$ polymer capacitor across the load.)	All		-	70	-	$mV_{rms}$
RMS (5Hz to 20MHz bandwidth)	All		-	200	-	$mV_{pk-pk}$
Peak-to-Peak (5Hz to 20MHz bandwidth)						
External Output Capacitance	All	$C_O$	220	-	10,000	$\mu F$
Output Current	All	$I_O$	0		17	$A_{dc}$
Output Current Limit Inception	All	$I_{O,lim}$	-	19	-	$A_{dc}$
Efficiency ( $V_{IN}=V_{IN,nom}$ , $V_O=V_{O,set}$ , $T_A=25^\circ C$ )						
$I_O=100\% I_{O,max}$	All	$\eta$		95.5		%
$I_O=40\% - 100\% I_{O,max}$	All	$\eta$		94.0		%
Switching Frequency (primary MOSFETs) (Output Ripple 2X switching frequency)		$f_{sw}$		150		kHz
Dynamic Load Response ( $dI_O/dt=1A/10\mu s$ ; $V_{in}=V_{in,nom}$ ; $T_A=25^\circ C$ ; tested with a $10\ \mu F$ ceramic and $1 \times 470\ \mu F$ polymer capacitor across the load.)						
Load Change from $I_O=50\%$ to $75\%$ of $I_{O,max}$ : Peak Deviation	All	$V_{pk}$	-	750	-	$mV_{pk}$
Settling Time ( $V_O<10\%$ peak deviation)		$T_s$	-	800	-	$\mu s$
Load Change from $I_O=75\%$ to $50\%$ of $I_{O,max}$ : Peak Deviation		$V_{pk}$	-	750	-	$mV_{pk}$
Settling Time ( $V_O<10\%$ peak deviation)		$t_{ss}$	-	800	-	$\mu s$

## Technical Specifications (continued)

### Isolation Specifications

Parameter	Symbol	Min	Typ	Max	Unit
Isolation Capacitance	$C_{iso}$	-	1000	-	pF
Isolation Resistance	$R_{iso}$	10	-	-	MΩ

### General Specifications

Parameter	Device	Symbol	Typ	Unit
Calculated Reliability based upon Telcordia SR-332 Issue 2: Method I Case 3 ( $I_o=80\%I_{o,max}$ , $T_A=40^\circ\text{C}$ , airflow = 200 lfm, 90% confidence)	All	MTBF	4,169,213	Hours
	All	FIT	239.9	$10^9/\text{Hours}$
Weight (Open Frame)			29.5 (1.04)	g (oz.)
Weight - with baseplate option			39.0 (1.38)	g (oz.)

### Feature Specifications

Unless otherwise indicated, specifications apply over all operating input voltage, resistive load, and temperature conditions. See Feature Descriptions for additional information.

Parameter	Device	Symbol	Min	Typ	Max	Unit
Remote On/Off Signal Interface $V_{IN}=V_{IN, min}$ to $V_{IN, max}$ , Signal referenced to $V_{IN-}$ terminal) (Negative Logic: device code suffix "1" Logic Low = module On, Logic High = module Off Positive Logic: No device code suffix required Logic Low = module Off, Logic High = module On Logic Low Specification On/Off Thresholds: Remote On/Off Current – Logic Low Logic Low Voltage Logic High Voltage – (Typ = Open Collector) Logic High maximum allowable leakage current ( $V_{on/off} = 2.0\text{V}$ ) Maximum voltage allowed on On/Off pin	All All All All All	$I_{on/off}$ $V_{on/off}$ $V_{on/off}$ $I_{on/off}$ $V_{on/off}$	280 -0.3 2.0 - -	- - - - -	310 0.8 14.5 10 14.5	$\mu\text{A}$ $V_{dc}$ $V_{dc}$ $\mu\text{A}$ $V_{dc}$
Turn-on Delay and Rise Time ( $I_o=I_{o,max}$ ) $T_{delay}$ =Time until $V_o = 10\%$ of $V_{o,set}$ from either application of $V_{in}$ with Remote On/Off set to On (Enable with $V_{in}$ ); or operation of Remote On/Off from Off to On with $V_{in}$ already applied for at least 150 milli-seconds (Enable with on/off). $T_{rise}$ =Time for $V_o$ to rise from 10% to 90% of $V_{o,set}$ , For $C_o > 5000\mu\text{F}$ , $I_o$ must be $< 50\%$ $I_{o,max}$ during $T_{rise}$ .	All All All	$T_{delay, Enable}$ with $V_{in}$ $T_{delay, Enable}$ with $V_{in}$ $T_{rise}$	- - -	- - -	160 40 40	ms ms ms
Prebias Output Load Performance: Back Bias current sunk by output during start-up Back Bias current sunk by output during shut-down	All All		- -	- -	50 50	mA mA
Output Overvoltage Protection	All	$V_{o,limt}$		17.0		$V_{dc}$
Overtemperature Protection (See Feature Descriptions)	All	$T_{ref}$	-	140	-	$^\circ\text{C}$
Input Undervoltage Lockout Turn-on Threshold Turn-off Threshold			- 32	35 33.3	36 -	$V_{dc}$ $V_{dc}$
Input Overvoltage Lockout Turn-off Threshold Turn-on Threshold			- 32	85 79	86 -	$V_{dc}$ $V_{dc}$

# Technical Specifications (continued)

## Characteristic Curves

The following figures provide typical characteristics for the EBVW017A0S14R0 (14.0V, 17A) at 25°C. The figures are identical for either positive or negative remote On/Off logic.

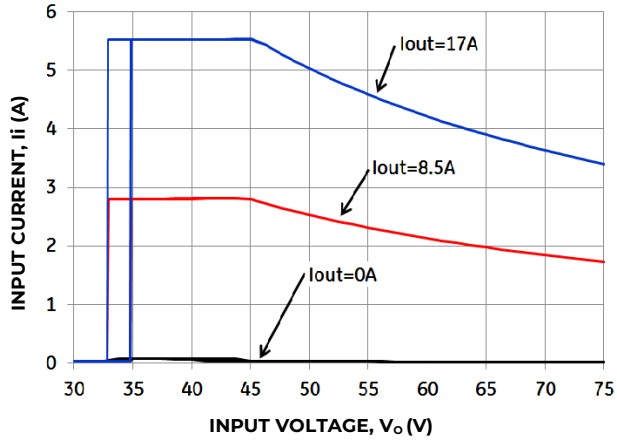

Figure 1. Typical Input Characteristic at Room Temperature.

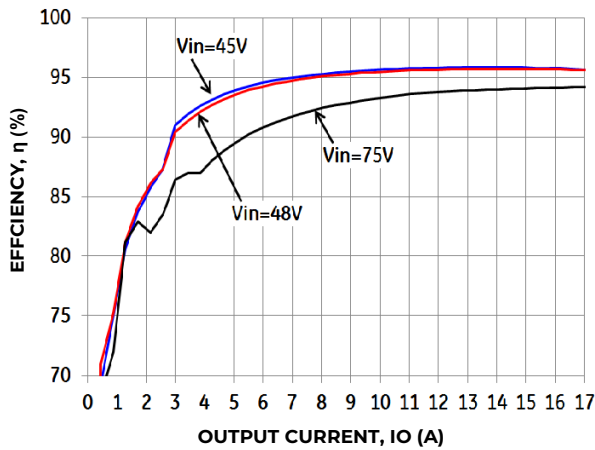

Figure 2. Typical converter Efficiency VS output current Temperature

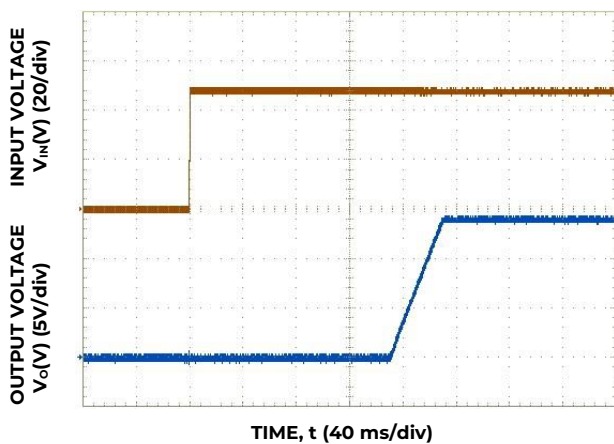

Figure 3. Typical Start-Up Using Vin with Remote On/Off enabled, negative logic version shown.

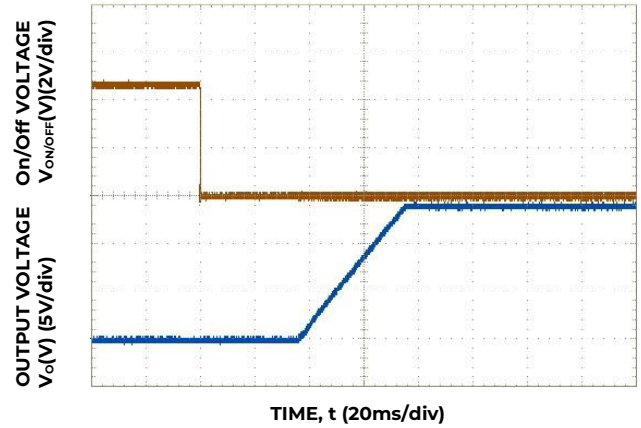

Figure 4. Typical Start-Up Using Remote On/Off with Vin applied, negative logic version shown.

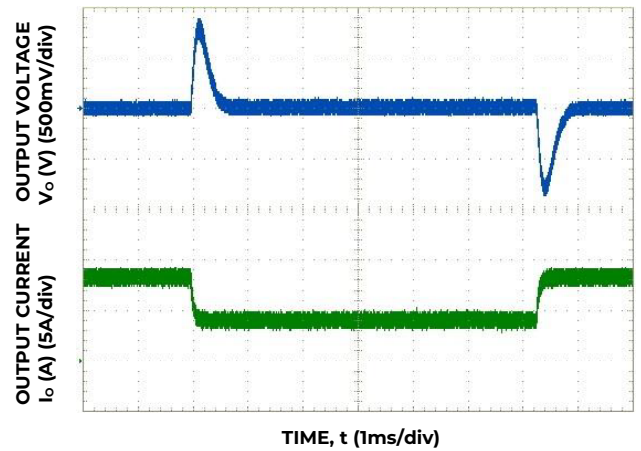

Figure 5. Typical Transient Response to Step change in Load from 25% to 50% to 25% of Full Load at 48 Vdc Input and 220uF Aluminum Cap.

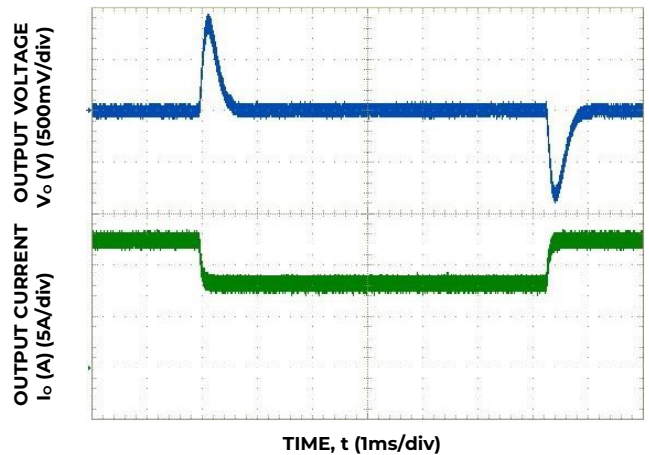

Figure 6. Typical Transient Response to Step Change in Load from 50% to 75% to 50% of Full Load at 48 Vdc Input and 220uF Aluminum Cap.

# Technical Specifications (continued)

## Characteristic Curves (continued)

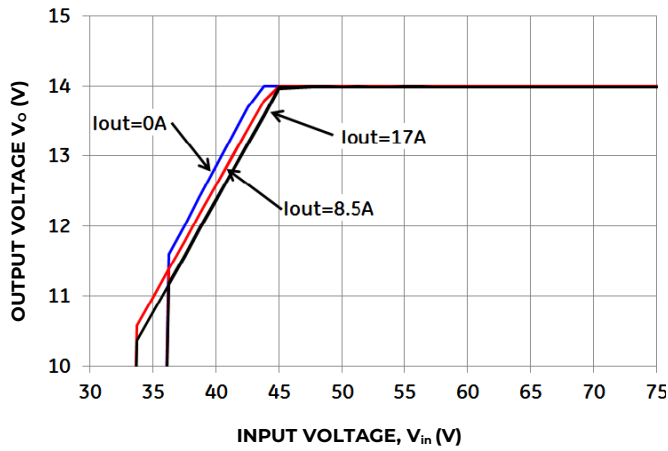

Figure 7. Typical output regulation vs Input voltage at room Temperature

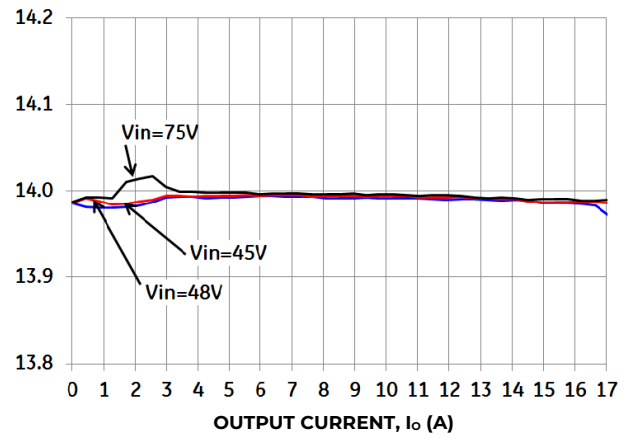

Figure 8. Typical Output Voltage Regulation vs. Output Current at Room Temperature.

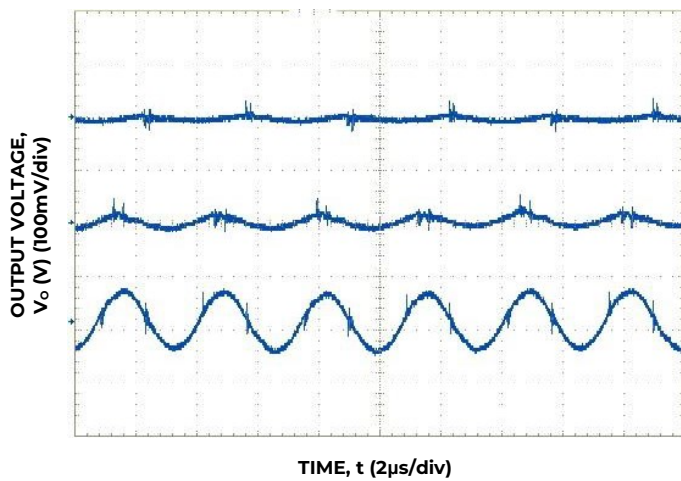

Figure 9. Typical Output Ripple and Noise at Room Temperature  
 $I_o = I_{o,max}$  and  $C_{oMin}$ .

## Technical Specifications (continued)

### Test Configurations

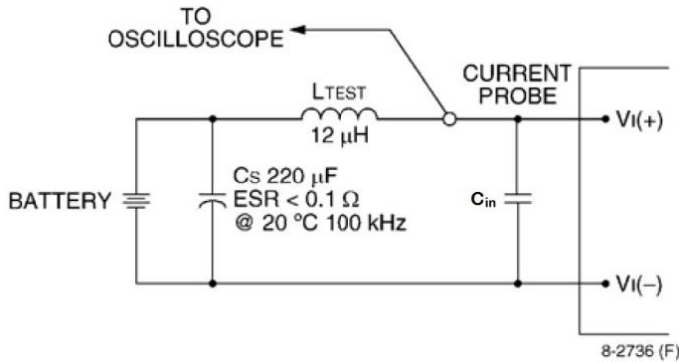

Figure 12. Input Reflected Ripple Current Test Setup.

**NOTE:** Measure input reflected ripple current with a simulated source inductance ( $L_{TEST}$ ) of  $12\mu\text{H}$ . Capacitor  $C_S$  offsets possible battery impedance. Measure current as shown above.

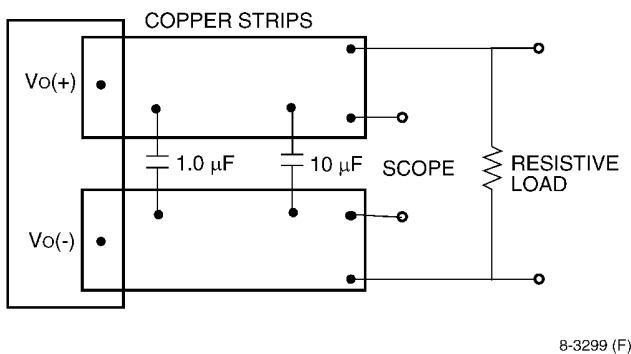

Figure 13. Output Ripple and Noise Test Setup.

**Note:** Use a  $1.0\mu\text{F}$  ceramic capacitor and a  $10\text{Mf}$  aluminum or tantalum capacitor. Scope measurement should be made using a BNC socket. Position the load between 51 mm and 76 mm (2 in. and 3 in.) from the module.

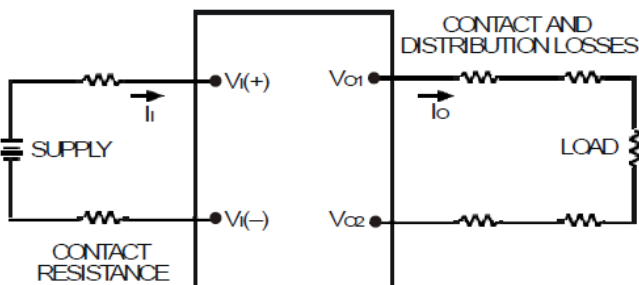

Figure 14. Output Voltage and Efficiency Test Setup.

**Note:** All measurements are taken at the module terminals. When socketing, place Kelvin connections at module terminals to avoid measurement errors due to socket contact resistance.

$$\eta = \left( \frac{[V_o(+)-V_o(-)] I_o}{[V_i(+)-V_i(-)] I_o} \right) \times 100\%$$

### Design Considerations

#### Input Source Impedance

The power module should be connected to a low ac-impedance source. A highly inductive source impedance can affect the stability of the power module. For the test configuration in Figure 12, a  $220\mu\text{F}$  electrolytic capacitor,  $C_{in}$ , ( $\text{ESR} < 0.7\Omega$  at  $100\text{kHz}$ ), mounted close to the power module helps ensure the stability of the unit. If the module is subjected to rapid on/off cycles, a  $330\mu\text{F}$  input capacitor is required. Consult the factory for further application guidelines.

#### Safety Considerations

For safety agency approval the power module must be installed in compliance with the spacing and separation requirements of the end-use safety agency standards, i.e., UL ANSI/UL\* 62368-1 and CAN/CSA+ C22.2 No. 62368-1 Recognized, DIN VDE 0868- 1/ A11:2017 (EN62368-1:2014/A11:2017)

If the input source is non-SELV (ELV or a hazardous voltage greater than  $60\text{V}_{dc}$  and less than or equal to  $75\text{V}_{dc}$ ), for the module's output to be considered as meeting the requirements for safety extra-low voltage (SELV) or ESI, all of the following must be true:

- The input source is to be provided with reinforced insulation from any other hazardous voltages, including the ac mains.
- One  $V_{IN}$  pin and one  $V_{OUT}$  pin are to be grounded, or both the input and output pins are to be kept floating.
- The input pins of the module are not operator accessible.
- Another SELV or ESI reliability test is conducted on the whole system (combination of supply source and subject module), as required by the safety agencies, to verify that under a single fault, hazardous voltages do not appear at the module's output.



## Technical Specifications (continued)

### Safety Considerations (Continued)

**Note:** Do not ground either of the input pins of the module without grounding one of the output pins. This may allow a non-SELV/ES1 voltage to appear between the output pins and ground.

The power module has safety extra-low voltage (SELV) or ES1 outputs when all inputs are SELV or ES1.

The input to these units is to be provided with a maximum 15 A fast-acting (or time-delay) fuse in the unearthed lead.

The power module has internally generated voltages exceeding safety extra-low voltage. Consideration should be taken to restrict operator accessibility.

### Feature Descriptions

#### Overcurrent Protection

To provide protection in a fault output overload condition, the module is equipped with internal current-limiting circuitry and can endure current limiting continuously. If the overcurrent condition causes the output voltage to fall greater than 4.0V from  $V_{o, set}$ , the module will shut down and remain latched off. The overcurrent latch is reset by either cycling the input power or by toggling the on/off pin for one second. If the output overload condition still exists when the module restarts, it will shut down again. This operation will continue indefinitely until the overcurrent condition is corrected.

A factory configured auto-restart option (with overcurrent and overvoltage auto-restart managed as a group) is also available. An auto-restart feature continually attempts to restore the operation until fault condition is cleared.

#### Remote On/Off

The module contains a standard on/off control circuit reference to the  $V_{IN}(-)$  terminal. Two factory configured remote on/off logic options are available. Positive logic remote on/off turns the module on during a logic-high voltage on the ON/OFF pin, and off during a logic low. Negative logic remote on/off turns the module off during a logic high, and on during a logic low. Negative logic, device code suffix "1," is the factory-preferred configuration. The On/Off circuit is powered from an internal bias supply, derived from the input voltage terminals. To turn the power module on and off, the user must supply a switch to control the voltage between the On/Off terminal and the  $V_{IN}(-)$  terminal ( $V_{on/off}$ ). The switch can be an open collector or equivalent (see Figure 15). A logic low is  $V_{on/off} = -0.3V$  to  $0.8V$ . The typical  $I_{on/off}$  during a logic low ( $V_{in}=48V$ , On/Off Terminal= $0.3V$ ) is  $147\mu A$ .

The switch should maintain a logic-low voltage while sinking  $310\mu A$ . During a logic high, the maximum  $V_{on/off}$  generated by the power module is  $8.2V$ . The maximum allowable leakage current of the switch at  $V_{on/off} = 2.0V$  is  $10\mu A$ . If using an external voltage source, the maximum voltage  $V_{on/off}$  on the pin is  $14.5V$  with respect to the  $V_{IN}(-)$  terminal.

If not using the remote on/off feature, perform one of the following to turn the unit on:

For negative logic, short ON/OFF pin to  $V_{IN}(-)$ .

For positive logic: leave ON/OFF pin open.

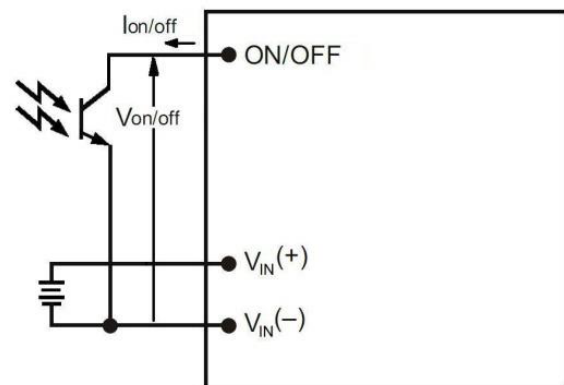

Figure 15. Remote On/Off Implementation.

#### Output Overvoltage Protection

The module contains circuitry to detect and respond to output overvoltage conditions. If the overvoltage condition causes the output voltage to rise above the limit in the Specifications Table, the module will shut down and remain latched off. The overvoltage latch is reset by either cycling the input power, or by toggling the on/off pin for one second. If the output overvoltage condition still exists when the module restarts, it will shut down again. This operation will continue indefinitely until the overvoltage condition is corrected.

A factory configured auto-restart option (with overcurrent and overvoltage auto-restart managed as a group) is also available. An auto-restart feature continually attempts to restore the operation until fault condition is cleared.

#### Overtemperature Protection

These modules feature an overtemperature protection circuit to safeguard against thermal damage. The circuit shuts down the module when the maximum device reference temperature is exceeded.

## Technical Specifications (continued)

The module will automatically restart once the reference temperature cools by  $\sim 25^{\circ}\text{C}$ .

### Input Under/Over voltage Lockout

At input voltages above or below the input under/over voltage lockout limits, module operation is disabled. The module will begin to operate when the input voltage level changes to within the under and overvoltage lockout limits.

### Thermal Considerations

The power modules operate in a variety of thermal environments and sufficient cooling should be provided to help ensure reliable operation.

Thermal considerations include ambient temperature, airflow, module power dissipation, and the need for increased reliability. A reduction in the operating temperature of the module will result in an increase in reliability. The thermal data presented here is based on physical measurements taken in a wind tunnel.

Heat-dissipating components are mounted on the top side of the module. Heat is removed by conduction, convection and radiation to the surrounding environment. Proper cooling can be verified by measuring the thermal reference temperature (THx). Peak temperature (THx) occurs at the position indicated in Figure 18 and 19. For reliable operation this temperature should not exceed the listed temperature threshold.

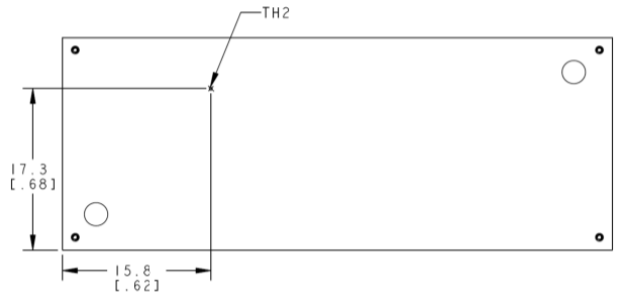

**Figure 19. Location of the thermal reference temperature TH2 for Base Plate module. Do not exceed  $110^{\circ}\text{C}$ .**

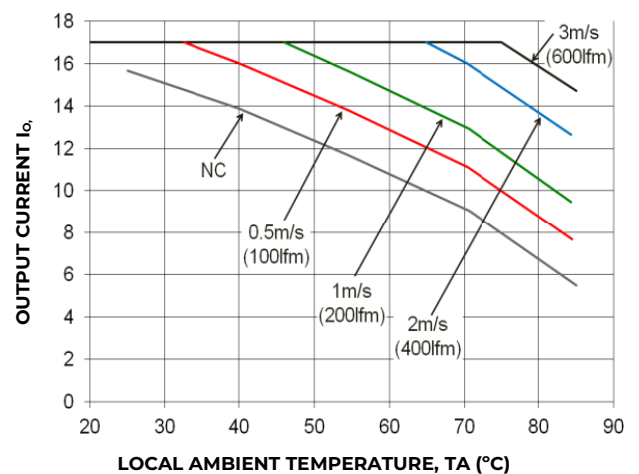

**Figure 20. Output Current Derating for the Open Frame EBVW017A0S14R0 in the Transverse Orientation; Airflow Direction from Vin(-) to Vin(+); Vin = 48V.**

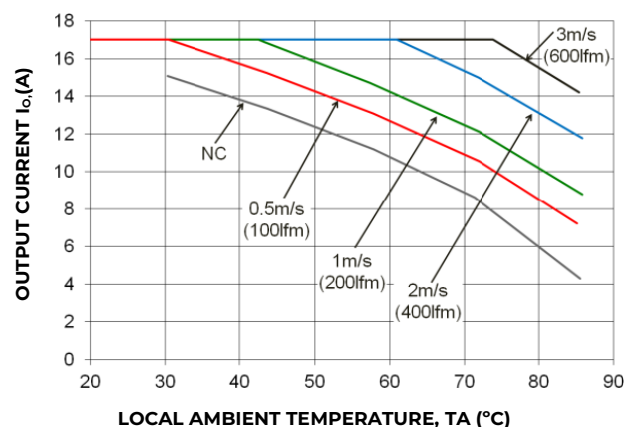

**Figure 21. Output Current Derating for the Base Plate EBVW017A0S14R0xx-H in the Transverse Orientation; Airflow Direction from Vin(-) to Vin(+); Vin = 48V.**

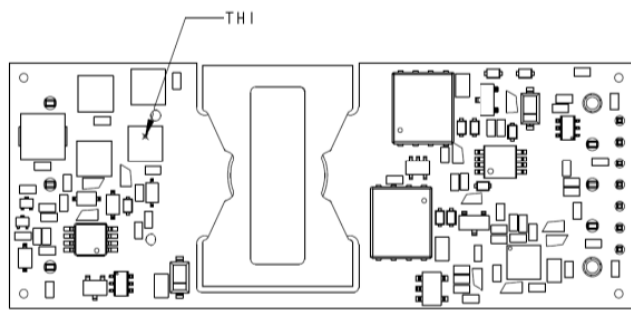

**Figure 18. Location of the thermal reference temperature TH1. Do not exceed  $113^{\circ}\text{C}$ .**

## Technical Specifications (continued)

### Feature Descriptions (continued)

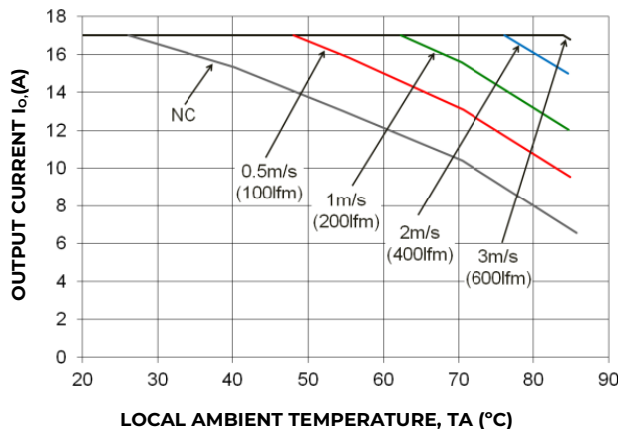

**Figure 22. Output Current Derating for the Base Plate**  
**EBVW017A0S14R0xx-H and 0.25" heat sink in the Transverse**  
**Orientation; Airflow Direction from Vin(-) to Vin(+); Vin = 48V.**

The output power of the module should not exceed the rated power for the module as listed in the Ordering Information table.

Although the maximum temperature of the power modules is THx, you can limit this temperature to a lower value for extremely high reliability.

Please refer to the Application Note "Thermal Characterization Process For Open-Frame Board-Mounted Power Modules" for a detailed discussion of thermal aspects including maximum device temperatures.

### Heat Transfer via Convection

Increased airflow over the module enhances the heat transfer via convection. The thermal derating of figures 20 through 22 show the maximum output current that can be delivered by each module in the indicated orientation without exceeding the maximum THx temperature versus local ambient temperature ( $T_A$ ) for air flows of, Natural Convection, 1 m/s (200 ft./min), 2 m/s (400 ft./min).

### Layout Considerations

The EBVW020 power module series are low profile in order to be used in fine pitch system card architectures. As such, component clearance between the bottom of the power module and the mounting board is limited. Avoid placing copper areas on the outer layer directly underneath the power module. Also avoid placing via interconnects underneath the power module.

For additional layout guide-lines, refer to FLT007A0Z Data Sheet.

### Through-Hole Lead-Free Soldering Information

The RoHS-compliant, Z version, through-hole products use the SAC (Sn/Ag/Cu) Pb-free solder and RoHS-compliant components. The non-Z version products use lead-tin (Pb/Sn) solder and RoHS-compliant components. Both version modules are designed to be processed through single or dual wave soldering machines. The pins have an RoHS-compliant, pure tin finish that is compatible with both Pb and Pb-free wave soldering processes. A maximum preheat rate of 3°C/s is suggested. The wave preheat process should be such that the temperature of the power module board is kept below 210°C. For Pb solder, the recommended pot temperature is 260°C, while the Pb-free solder pot is 270°C max. Not all RoHS-compliant through hole products can be processed with paste-through-hole Pb or Pb-free reflow process. If additional information is needed, please consult with your OmniOn representative for more details.

### Reflow Lead-Free Soldering Information

The RoHS-compliant through-hole products can be processed with the following paste-through-hole Pb or Pbfree reflow process.

Max. sustain temperature :  
 245°C (J-STD-020C Table 4-2: Packaging Thickness  $\geq$  2.5mm / Volume  $>$  2000mm<sup>3</sup>),  
 Peak temperature over 245°C is not suggested due to the potential reliability risk of components under continuous high-temperature.  
 Min. sustain duration above 217°C : 90 seconds  
 Min. sustain duration above 180°C : 150 seconds  
 Max. heat up rate: 3°C/sec  
 Max. cool down rate: 4°C/sec In compliance with JEDEC J-STD-020C spec for 2 times reflow requirement.

### Pb-free Reflow Profile

BMP module will comply with J-STD-020 Rev. C (Moisture/Reflow Sensitivity Classification for Nonhermetic Solid State Surface Mount Devices) for both Pb-free solder profiles and MSL classification procedures. BMP will comply with JEDEC J-STD-020C specification for 3 times reflow requirement. The suggested Pb-free solder paste is Sn/Ag/Cu (SAC). The recommended linear reflow profile using Sn/Ag/Cu solder is shown in Figure 23.

## Technical Specifications (continued)

### Reflow Lead-Free Soldering Information (continued)

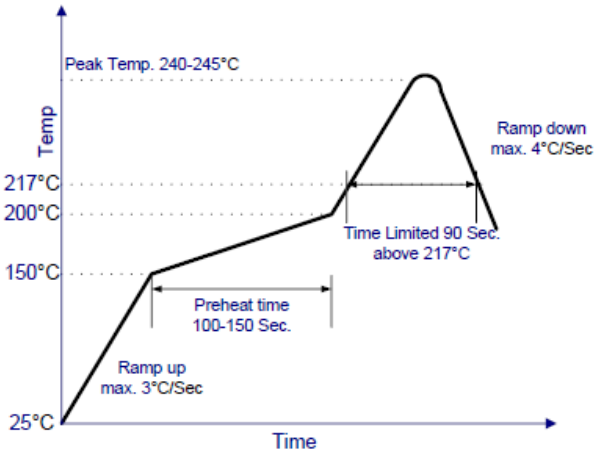

Figure 23. Recommended linear reflow profile using Sn/Ag/Cu solder.

### MSL Rating

The EBVW017A0S14R0 modules have a MSL rating as indicated in the Device Codes table, last page of this document.

### Storage and Handling

The recommended storage environment and handling procedures for moisture-sensitive surface mount packages is detailed in J-STD-033 Rev. A (Handling, Packing, Shipping and Use of Moisture/Reflow Sensitive Surface Mount Devices). Moisture barrier bags (MBB) with desiccant are required for MSL ratings of 2 or greater. These sealed packages should not be broken until time of use. Once the original package is broken, the floor life of the product at conditions of  $\leq 30^{\circ}\text{C}$  and 60% relative humidity varies according to the MSL rating (see J-STD-025A). The shelf life for dry packed SMT packages will be a minimum of 12 months from the bag seal date, when stored at the following conditions:  $< 40^{\circ}\text{C}$ ,  $< 90\%$  relative humidity.

### Post Solder Cleaning and Drying Considerations

Post solder cleaning is usually the final circuit-board assembly process prior to electrical board testing. The result of inadequate cleaning and drying can affect both the reliability of a power module and the testability of the finished circuit-board assembly. For guidance on appropriate soldering, cleaning and drying procedures, refer to OmniOn Board Mounted Power Modules: Soldering and Cleaning Application Note (AP01-056EPS).

# Technical Specifications (continued)

## EMC Considerations

The circuit and plots in Figure 24 shows a suggested configuration to meet the conducted emission limits of EN55032 Class B. For further information on designing for EMC compliance, please refer to the FLT007A0 data sheet.

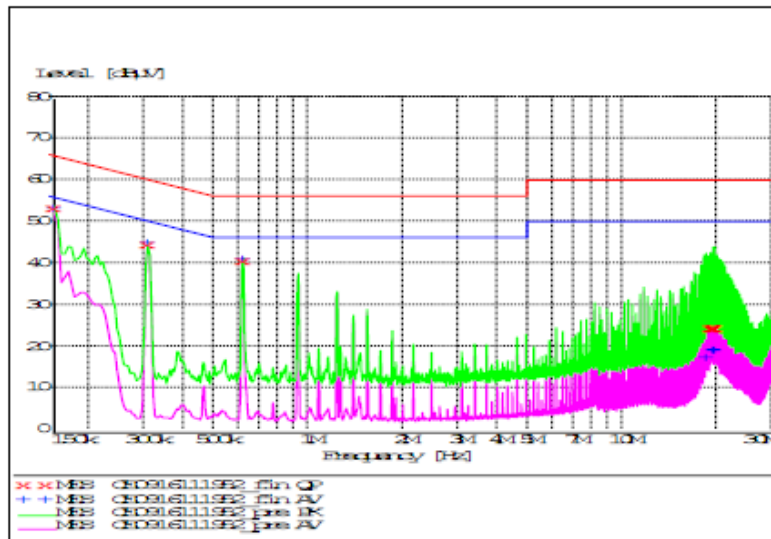
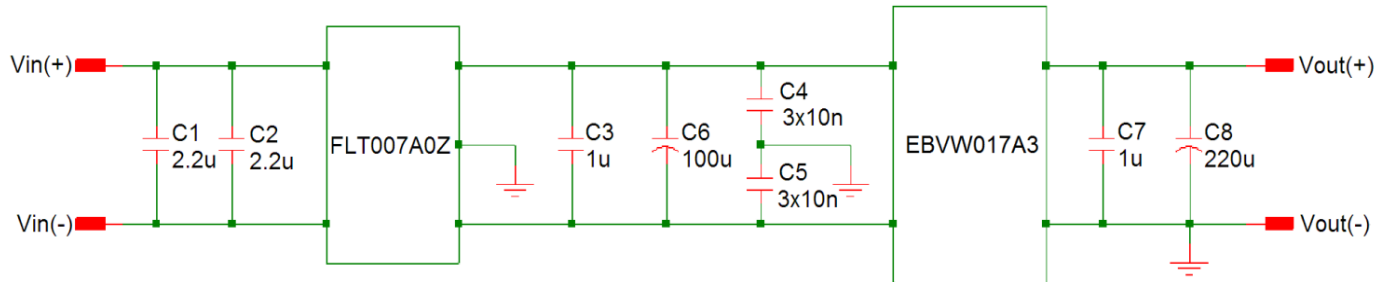

Figure 24. EMC Considerations.

# Technical Specifications (continued)

## Packaging Details

All versions of the EBVW017A0S14R0 are supplied as standard in the plastic trays shown in Figure 25.

## Tray Specification

Material PET (1mm)

Max surface resistivity 109 -1011Ω/PET

Color Clear

Capacity 18 power modules

Min order quantity 36 pcs (1 box of 2 full trays + 1 empty top tray)

Each tray contains a total of 18 power modules. The trays are self-stacking and each shipping box for the EBVW017A0S14R0 module contains 2 full trays plus one empty hold-down tray giving a total number of 36 power module



Figure 25. EBVW020 Packaging Tray

# Technical Specifications (continued)

## Mechanical Outline for EBVW017A0S14R0 Through-hole Module

Dimensions are in millimeters and [inches].

Tolerances: x.x mm ±0.5 mm [x.xx in. ± 0.02 in.] (Unless otherwise indicated)

x.xx mm ± 0.25 mm [x.xxx in ± 0.010 in.]

Top side label includes OmniOn name, product designation and date code.

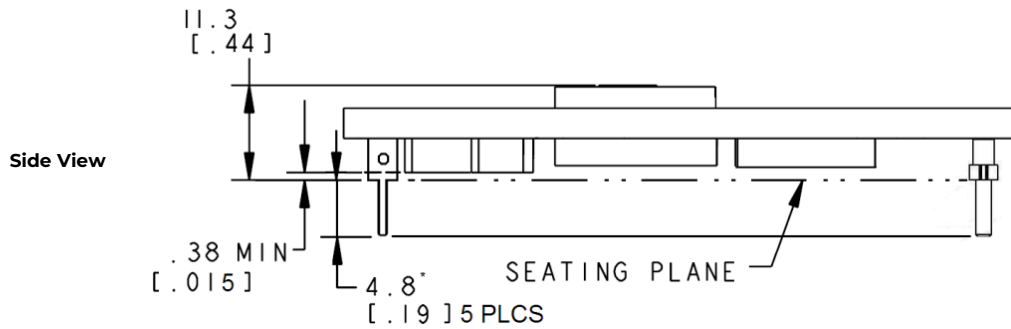
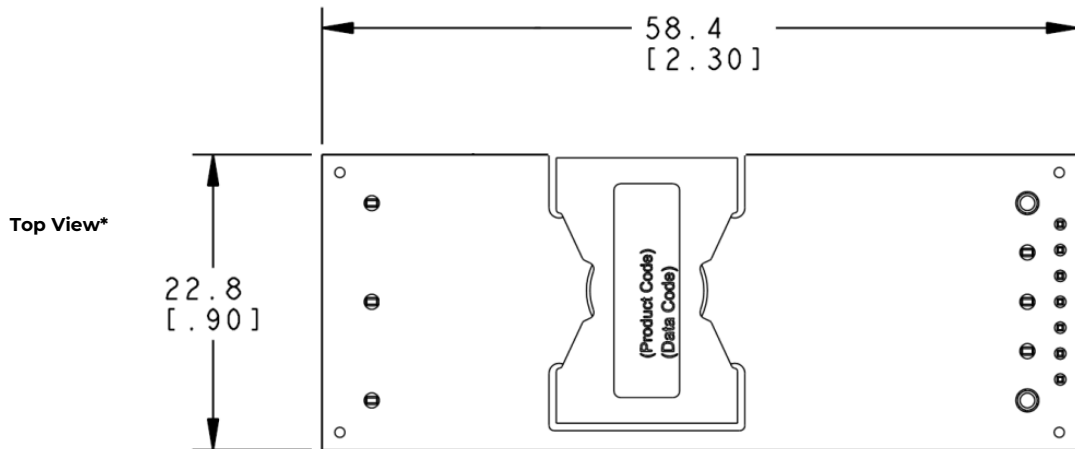

\*For optional pin lengths, see Table 2, Device Coding Scheme and Options

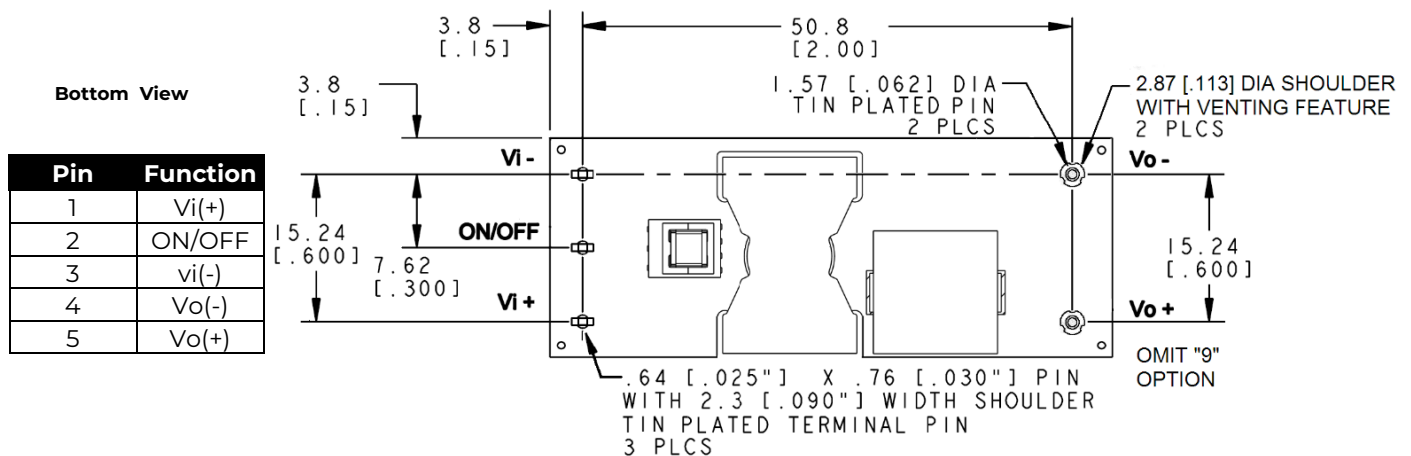

Pin	Function
1	Vi(+)
2	ON/OFF
3	vi(-)
4	Vo(-)
5	Vo(+)

# Technical Specifications (continued)

## Mechanical Outline for EBVW017A0S14R0–H (Baseplate version) Through-hole Module

Dimensions are in millimeters and [inches].

Tolerances: x.x mm ± 0.5 mm [x.xx in. ± 0.02 in.] (Unless otherwise indicated)

x.xx mm ± 0.25 mm [x.xxx in ± 0.010 in.]

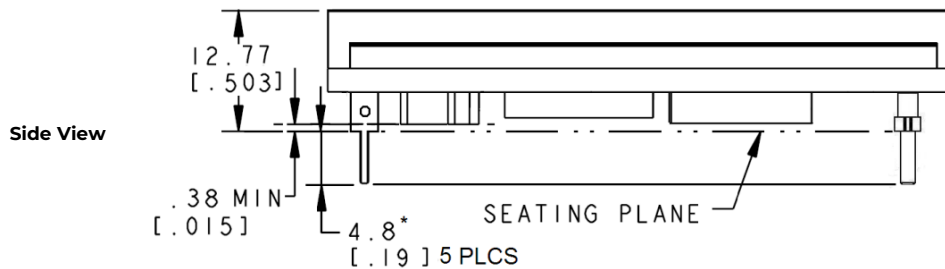
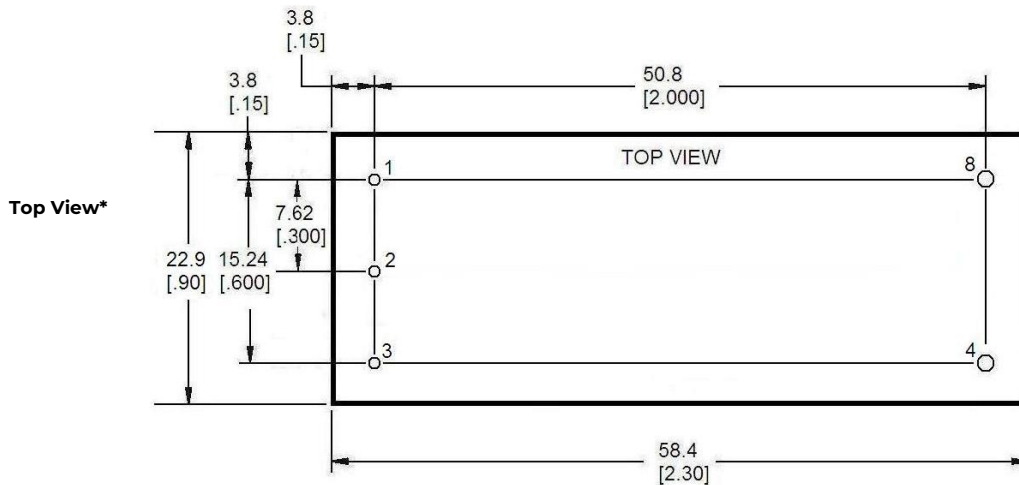

\*For optional pin lengths, see Table 2, Device Coding Scheme and Options

\* Bottom side label includes OmniOn name, product designation and date

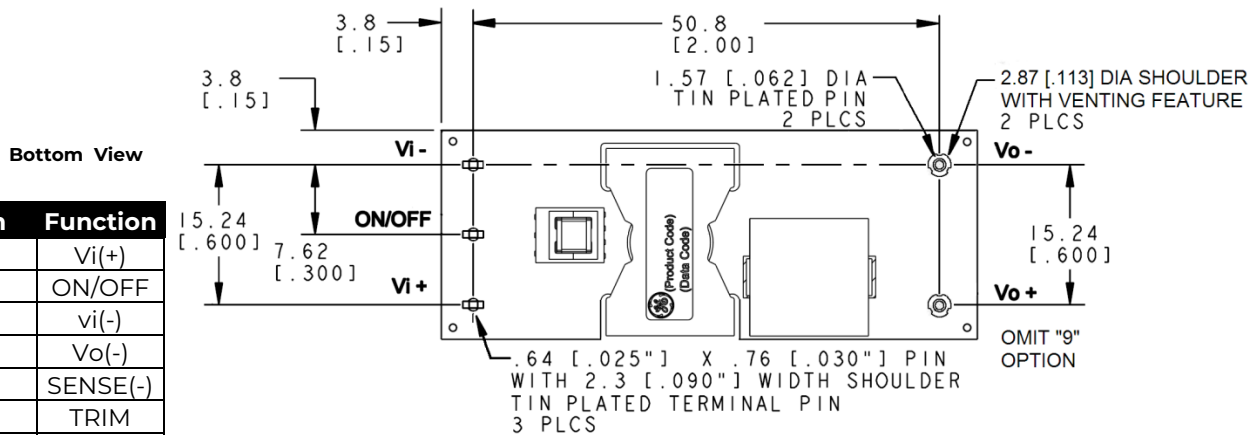

Pin	Function
1	Vi(+)
2	ON/OFF
3	vi(-)
4	Vo(-)
5	SENSE(-)
6	TRIM
7	SENSE(+)
8	Vo(+)



## Technical Specifications (continued)

### Recommended Pad Layout

Dimensions are in millimeters and [inches].

Tolerances: x.x mm ± 0.5 mm [x.xx in. ± 0.02 in.] (Unless otherwise indicated)

x.xx mm ± 0.25 mm [x.xxx in ± 0.010 in.]

### Through-Hole Modules

Pin	Function
1	Vi(+)
2	ON/OFF
3	vi(-)
4	Vo(-)
5	SENSE(-)
6	TRIM
7	SENSE(+)
8	Vo(+)

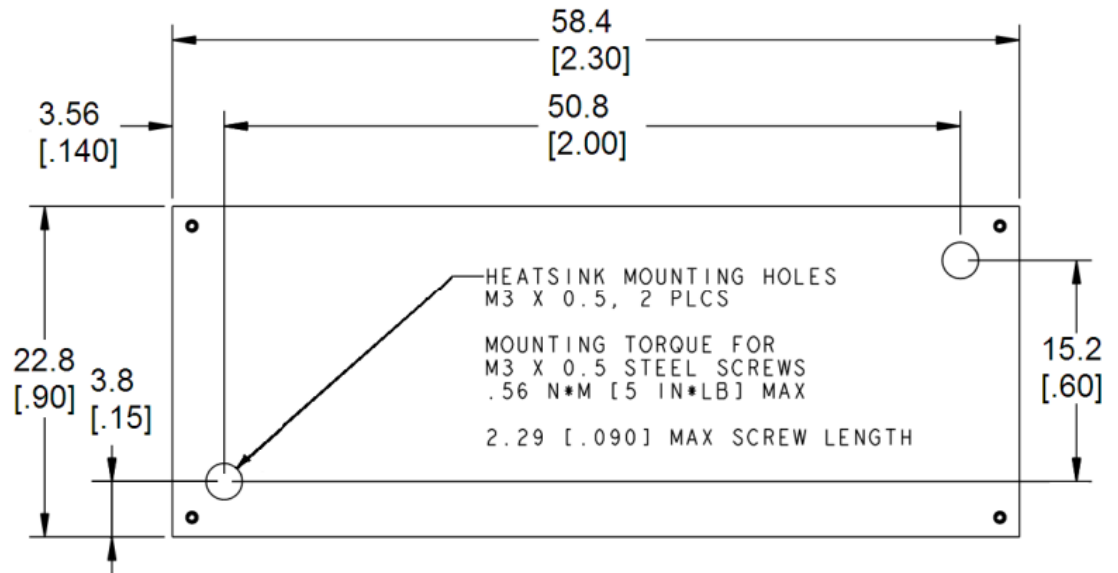

## Technical Specifications (continued)

### Ordering Information

Please contact your OmniOn Sales Representative for pricing, availability and optional features.

Product Code	Input Voltage	Output Voltage	Output Current	Efficiency	Connector Type	MSL Rating	Ordering Code
EBVW017A0S14R0641Z	48V (36-75V <sub>dc</sub> )	14.0V	17A	95.5%	Through hole	2a	150022524

Table 1. Device Codes

Characteristic		Character and Position										Definition		
Ratings	Form Factor	E											E = Eight Brick	
	Family Designator	BV											BV = BARRACUDA Series, without PMBus interface	
	Input Voltage	W											W = Wide Range, 36-75V	
	Output Current		017A0										017A0 = 017.0 Amps Maximum Output Current	
	Output Voltage			S14R0									S14R0 =14.0V nominal	
Options	Pin Length						8 6						Omit = Default Pin Length shown in Mechanical Outline Figures 8 = Pin Length: 3.68 mm ± 0.25mm , (0.145 in. ± 0.010 in.) 6 = Pin Length: 2.79 mm ± 0.25mm , (0.110 in. ± 0.010 in.)	
	Action following Protective Shutdown						4						Omit = Latching Mode 4 = Auto restart following shutdown (overcurrent/overvoltage)	
	On/ Off Logic						1						Omit = Positive Logic 1 = Negative Logic	
								-						
	Customer Specific								XY					XY= Customer Specific Modified Code, Omit for Standard Code
	Optional Features									H				Omit = Standard open Frame Module H= Heat plate, for use with heat sink or cold-walls
	RoHS												Z	Z = RoHS Compliant

Table 2. Device Options

### Contact Us

For more information, call us at

1-877-546-3243 (US)

1-972-244-9288 (Int'l)

## Change History (excludes grammar & clarifications)

Revision	Date	Description of the change
1.3	04/08/2022	Updated as per template, ROHS
1.4	12/04/2023	Updated as per OmniOn template

**OmniOn Power Inc.**

601 Shiloh Rd.  
Plano, TX USA

[omnionpower.com](http://omnionpower.com)

We reserve the right to make technical changes or modify the contents of this document without prior notice. OmniOn Power does not accept any responsibility for errors or lack of information in this document and makes no warranty with respect to and assumes no liability as a result of any use of information in this document.

We reserve all rights in this document and in the subject matter and illustrations contained therein. Any reproduction, disclosure to third parties or utilization of its contents – in whole or in parts – is forbidden without prior written consent of OmniOn Power. This document does not convey license to any patent or any intellectual property right. Copyright© 2023 OmniOn Power Inc. All rights reserved.