

CLP0228 Open Frame Power Supply

90-264V_{ac} Input; 28V_{dc} Output; 200W Output Power

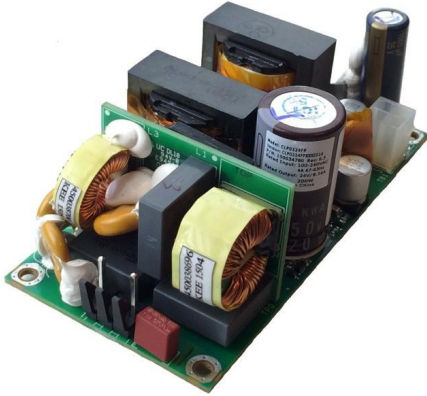

Description

In a small 2 x 4 inch footprint, the 28Vdc single-output CLP0228 open frame power supply delivers greater than 90 percent typical power efficiency and full load output at +50°C. With its small size, the CLP series is specifically designed to handle power challenges associated with tight space and low airflow. Offering a leading 18W/in³ power density in a 1U

high, fan-less form factor, the CLP series addresses a broad range of applications in new products from industrial equipment and communications original equipment manufacturers (OEMs). Higher temperature operation is possible at derated output. The CLP series utilizes a unique design approach at this power level, leveraging zero voltage switching techniques in conjunction with quasi-resonant power factor correction (PFC) circuits. Protection features include overcurrent (OCP), overvoltage (OVP), and overtemperature (OTP).

Applications

- Industrial equipment
- Telecommunications equipment

Features

- Compact size 50.8 mm x 101.6 mm x 37.2 mm (2 in x 4 in x 1.46 in) with density of 18 W/in³
- Universal AC Input Range (90 – 264VAC)
- Output voltage of 28V (adjustable ±5%)
- Maximum output current of 7.1A@ 28Vout (200W)
- High efficiency (93.6 % at Full Load, 230VAC in)
- Full load capability at 50°C and 1m/s airflow with derating at higher temperatures or lower airflows
- Output overcurrent protection (non-latching)
- Overtemperature protection
- Output overvoltage protection
- Up to 11ms of holdup time at 200W out
- Active power factor corrected input
- Conducted EMI - meets CISPR32 (EN55032) and FCC Class B requirements
- Compliant to RoHS II EU “Directive 2011/65/EU” and amended Directive (EU) 2015/863.
- Compliant to REACH Directive (EC) No 1907/2006
- UL and cUL approved to UL/CSA62368-1, TUV (EN62368- 1), CE Mark (for LVD) and CB Report available
- ISO** 9001 and ISO 14001 certified manufacturing facilities

Footnotes

*UL is a registered trademark of Underwriters Laboratories, Inc.

†CSA is a registered trademark of Canadian Standards Association.

‡VDE is a registered trademark of Verband Deutscher Elektrotechniker e.V.

** ISO is a registered trademark of the International Organization of Standard

Technical Specifications

Absolute Maximum Ratings

Stresses in excess of the absolute maximum ratings can cause permanent damage to the device. Functional operation of the device is not implied at these or any other conditions over those given in the operations sections of the data sheet. Exposure to absolute maximum ratings for extended periods can adversely affect the device reliability.

Parameter	Device	Min	Max	Unit
Input Voltage - Continuous	All	90	264	V _{ac}
Operating Ambient Temperature (see Thermal Considerations section)	All	-40	85	°C
Storage Temperature	All	-40	85	°C
Humidity (non-condensing)	All	5	95	%
Altitude	All		5000	m
Isolation Voltage – Input to output	All		3000	V _{ac}
Input to safety ground	All		1500	V _{ac}
Outputs to safety ground	All		50	V _{ac}

Electrical Specifications

Parameter	Device	Min	Typ	Max	Unit
Operating Input Voltage	All	90	115/230	264	V _{ac}
Input Source Frequency	All	47	50/60	63	Hz
Input Current (V _{IN} = 90V _{ac})	All			4	A _{RMS}
Input Power Factor (115VAC or 230VAC in at full load)	All	0.95			
Inrush Transient Current (V _{IN} = 264V _{ac} , T _{amb} = 25°C)	All			100	A Peak
Leakage Current to earth ground (V _{IN} = 264V _{ac})	All			2	mA
Output Voltage Setpoint	All		28		V _{dc}
Output Voltage Tolerance (due to set point, temperature)	All	-3		3	%
Output Voltage Adjustment Range	All	26.6		29.4	V _{dc}
Output Load Regulation	All			1	%V _{out}
Output Line Regulation	All			0.5	%V _{out}
Output Ripple and Noise – measured with 0.1µF ceramic capacitor in parallel with 10µF electrolytic capacitor, at 25°C ¹ Peak-to-peak (20MHz Bandwidth)	All			360	mV _{p-p}
Dynamic Load Response – 50% to 100% load transient, 1A/µs slew rate	All			5%	%
Output voltage deviation	All			500	µs
Settling Time					
Output Current	All	0		7.1	A _{dc}
Output Current Limit Inception	All	110		160	% I _{o,max}
Maximum Output Capacitance	All			3000	µF

¹ Below -25°C, output ripple may exceed the specified level. Specification will be met after warm up period of 15s.

Technical Specifications (continued)

Electrical Specifications (continued)

Parameter	Device	Min	Typ	Max	Unit
Efficiency at 25°C:					
$V_{IN} = 230V_{ac}$, 20% load	All		88.9		%
50% load	All		93.3	-	%
100% load	All		93.6		%
$V_{IN} = 115V_{ac}$, 20% load	All		88.7		%
50% load	All		91.8		%
100% load	All		91.5		%
Holdup Time – $V_{IN} = 115V_{ac}$, 100% load	All	11			ms
$V_{IN} = 230V_{ac}$, 100% load	All	11			ms

General Specifications

Parameter	Device	Symbol	Typ	Unit
Calculated Reliability based on Telcordia SR-332 Issue 2: Method 1 Case 3 ($V_{IN}=230V_{ac}$, $I_o = 7.1A$, $T_A = 40^{\circ}C$, airflow 200LFM, 90% confidence)	All	FIT MTBF	287.3 3,480,997	10^9 /Hours Hours
Weight	All		198 7.0	g (oz.)

Feature Specifications

Parameter	Device	Min	Typ	Max	Unit
Output Voltage Rise Time (from 10 to 90% of final value)	All		20		ms
Delay from Input being applied to all outputs being in	All		2000		ms
Output Overvoltage Protection	All	31.4		35	V_{dc}
Input Undervoltage lockout ²					
Turn-on Threshold	All	75	80	90	V_{ac}
Turn-off Threshold	All	65	75	88	V_{ac}

²The undervoltage lockout thresholds vary with output load current level – decreasing as the load goes down

Technical Specifications (continued)

Environmental Specifications

Parameter	Device	Specification/Test
Conducted Emissions	All	CISPR32 (EN55032) Class A with 3dB margin
Radiated Emissions	All	CISPR32 (EN55032) to comply with system enclosure
ESD	All	IEC61000-4-2, Level 3
Radiated Susceptibility	All	IEC61000-4-3, Level 2
Electrical Fast Transient Common Mode	All	IEC61000-4-4, Level 3
Surge Immunity	All	IEC61000-4-5, Level 3
Conducted RF Immunity	All	IEC61000-4-6, Level 3
Input Voltage Dips	All	Output stays within regulation for either ½ cycle
Input Harmonics	All	IEC61000-3-2
Shock and Vibration	All	IPC-9592B

Safety Specifications

Parameter	Device	Specification
Dielectric Withstand Voltage (between input and output)	All	Minimum of 4,250Vdc for 1 minute
Insulation Resistance (between input and output)	All	Minimum of 5 MW
Safety Standards	All	Class 1, IEC62368, EN62368, with the following deviations: Nemko, UL 62368 (Recognized Component), cUL (Canadian Approval by UL)

Technical Specifications (continued)

Characteristic Curves

The following figures provide typical characteristics for the CLP0228 power supply.

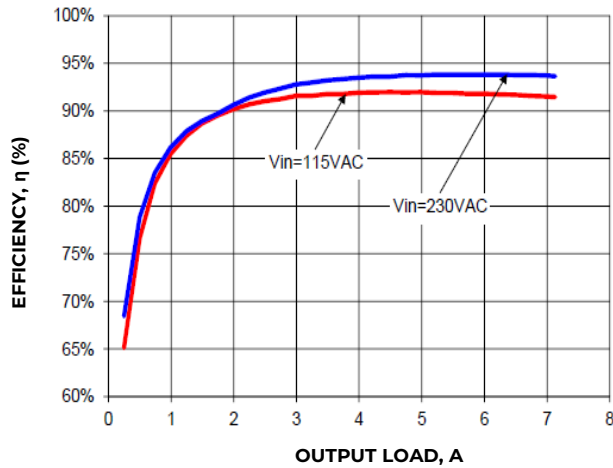

Figure 1. Power Supply Efficiency versus Output Current.

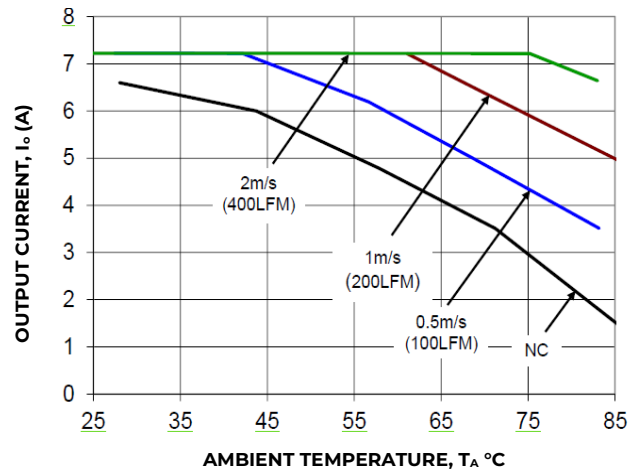

Figure 2. Derating Output Current versus Ambient Temperature and Airflow. Data shown for 115V_{AC} in, at 230V_{AC} in derating is the same or better. For derating at other input voltages, consult the OmniOn Technical representative.

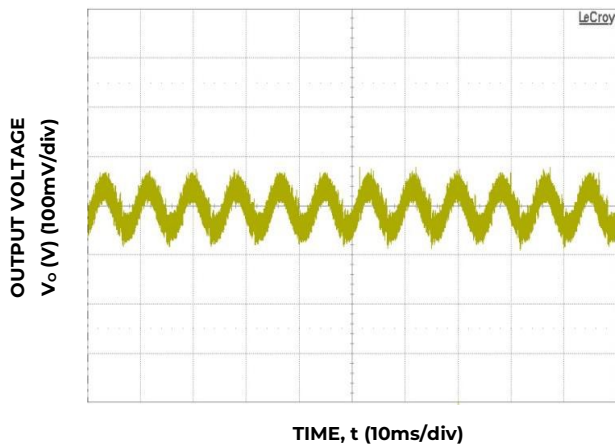

Figure 3. Typical output ripple and noise ($V_{IN} = 230V_{ac}$, 100% load).

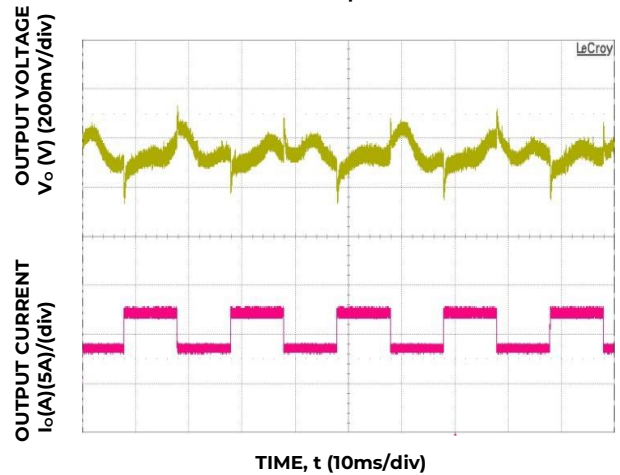

Figure 4. Transient Response to Dynamic Load Change from 50% to 100% at $V_{IN} = 230V_{ac}$.

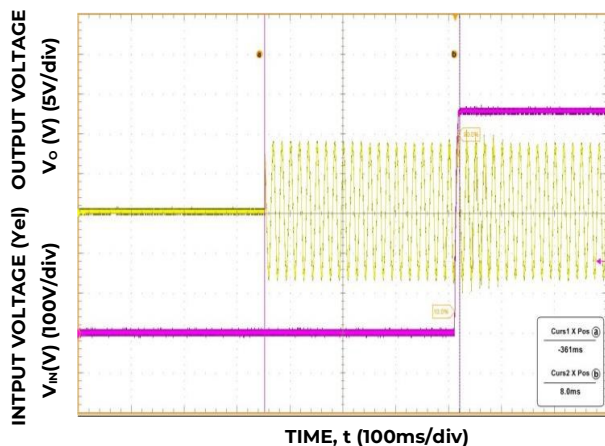

Figure 5. Typical Start-up ($V_{IN} = 115V_{ac}$, Full Load).

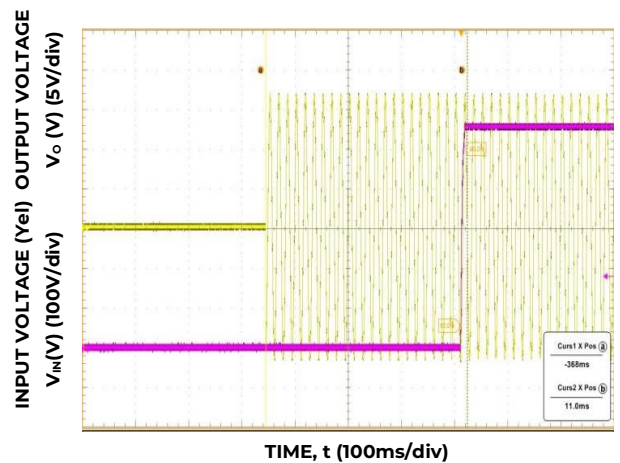

Figure 6. Typical Start-up ($V_{IN} = 230V_{ac}$, Full load)

Technical Specifications (continued)

Safety Considerations

The CLP0228 power supply is intended for inclusion in other equipment and the installer must ensure that it is in compliance with all the requirements of the end application. This product is only for inclusion by professional installers within other equipment and must not be operated as a stand-alone product. The power supply meets Class 1, IEC62368-1, EN62368-1, with the applicable national deviations which approved by TUV and UL (Recognized Component) C-UL (Canadian Approval by UL).

Feature Descriptions

On/Off Considerations

The power supply output is available when the AC input is within operating range. No On/Off control is provided.

Output Voltage Adjustment

The output voltage can be adjusted between 26.6V and 29.4V using a potentiometer on the power supply.

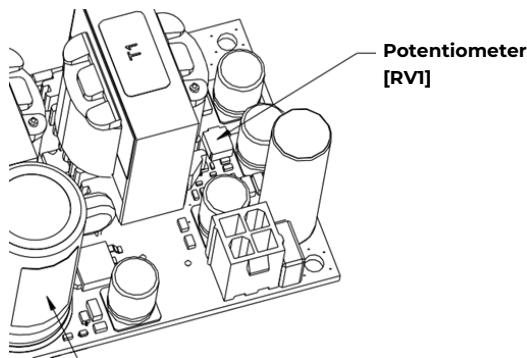

Fig. 9. Diagram showing location of the potentiometer used to adjust the power supply output voltage.

Overcurrent Protection

To provide protection in a fault condition (output overload), the power supply is equipped with internal current-limiting circuitry and can endure current limiting continuously. At the point of current-limit inception, the unit enters hiccup mode. The power supply operates normally once the output current is brought back into its specified range.

Overvoltage Protection

Overvoltage protection is a feature of the CLP0228 power supply that protects both the load and the power supply from an output overvoltage condition. When an overvoltage occurs, the power supply shuts down and latches off until the overvoltage condition is removed. It is necessary to recycle the input to restart the power supply when this protection is activated.

Overtemperature Protection

The CLP0228 also features overtemperature protection in order to provide additional protection in a fault condition. The power supply is equipped with a thermal shutdown circuit which detects excessive internal temperatures and shuts the unit down. Once the power supply goes into overtemperature shutdown, it will cool before attempting to restart. The overtemperature protection circuit will typically kick in when the unit is operated at 200W output with an ambient temperature of 75°C and 1m/s (200LFM) airflow, when input voltage is 115V_{ac}. At 230V_{ac}, the OTP kicks in at 80°C.

Input Undervoltage Lockout

At input voltages below the input undervoltage lockout limit, power supply operation is disabled. The power supply will begin to operate at an input voltage above the undervoltage lockout turn-on threshold.

Thermal Considerations

The power supply can be operated in a variety of thermal environments; however sufficient cooling should be provided to ensure reliable operation.

Considerations include ambient temperature, airflow, power supply dissipation and the need for increased reliability. A reduction in the operating temperature of the power supply will result in increased reliability. The thermal data presented here is based on measurements taken in a wind tunnel.

Heat Transfer via Convection

Increased airflow through the power supply enhances the heat transfer via convection. Figure 11 shows the preferred airflow direction. Contact your OmniOn technical representative for derating information in other airflow directions.

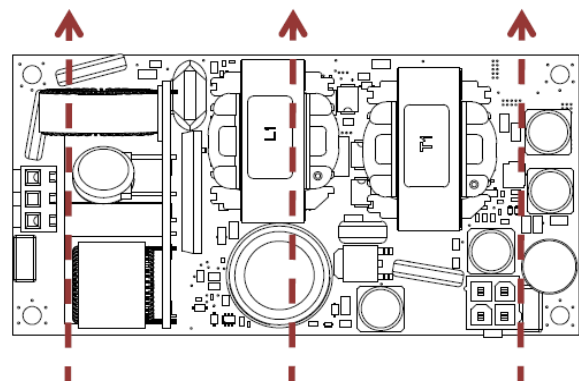

Fig. 10. Preferred airflow direction for cooling.

Technical Specifications (continued)

Operation in a Sealed Enclosure

The CLP0228 power supply can also be operated in a sealed enclosure provided proper means for removing heat from the power supply are used. Figure 11 shows an arrangement where a thermally conductive pad is used to transfer heat from the bottom of the power supply into the enclosure. Under such conditions, the power supply is capable of reduced power operation as shown in Table 1. Note that the Ambient Temperature shown in Table 1 is that outside the sealed enclosure, the CLP0228 may see higher ambient temperatures.

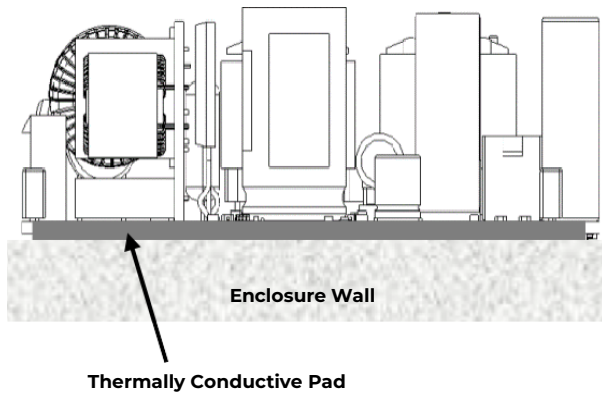

Fig. 11. Example arrangement of the CLP0228 for sealed enclosure applications

Ambient Temperature (°C)	Max. Output Power (W)
25	190
40	175
55	140

Table 1. Output Power Capability when the CLP0228 is operated in a sealed enclosure with thermal pad for conduction cooling.

Technical Specifications (continued)

Mechanical Outline

Dimensions are in millimeters.

Tolerances: x.x mm ± 0.5mm [unless otherwise indicated]

x.xx mm ± 0.25mm

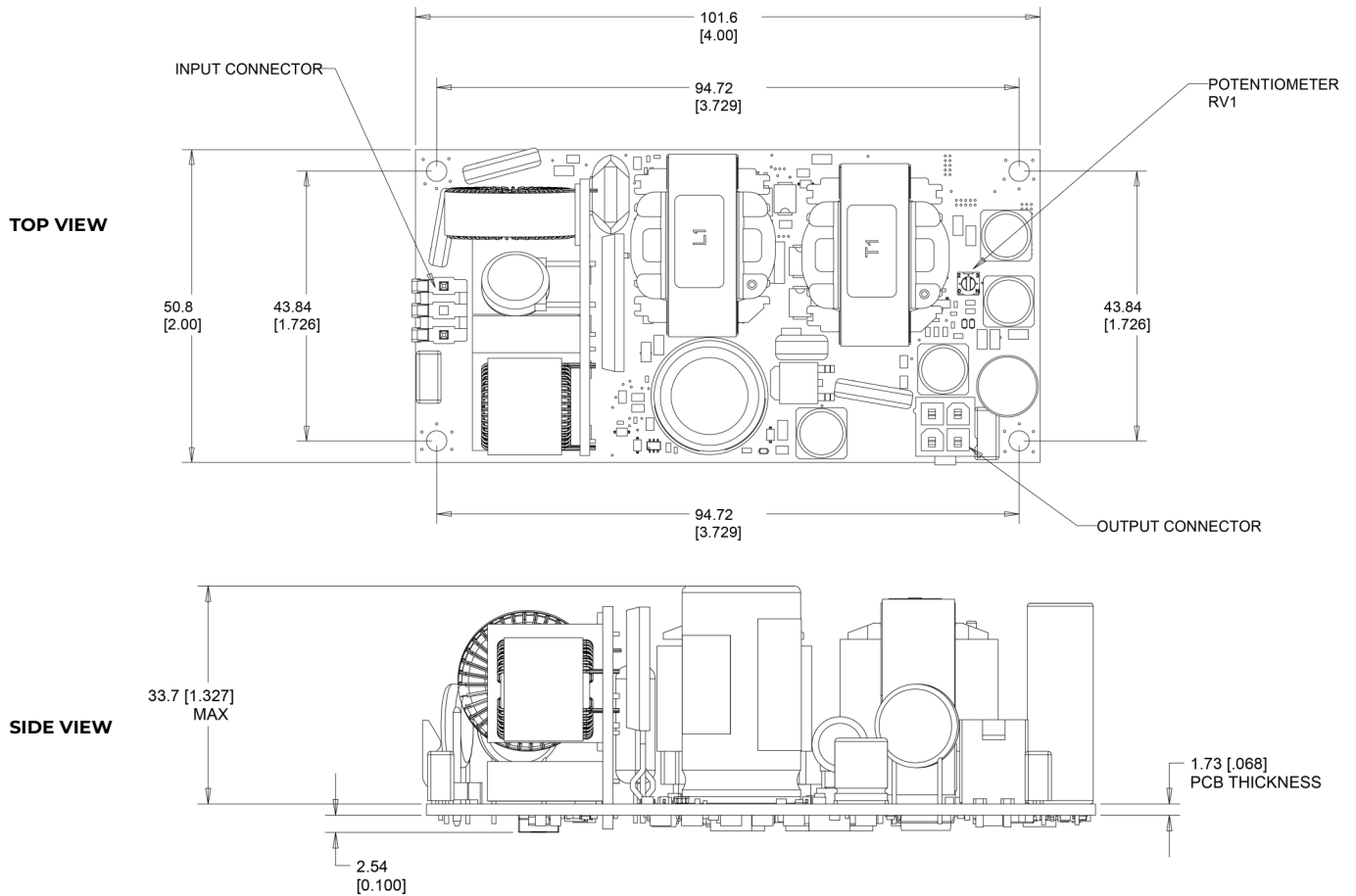

Minimum clearance of 6mm required on bottom of the unit.

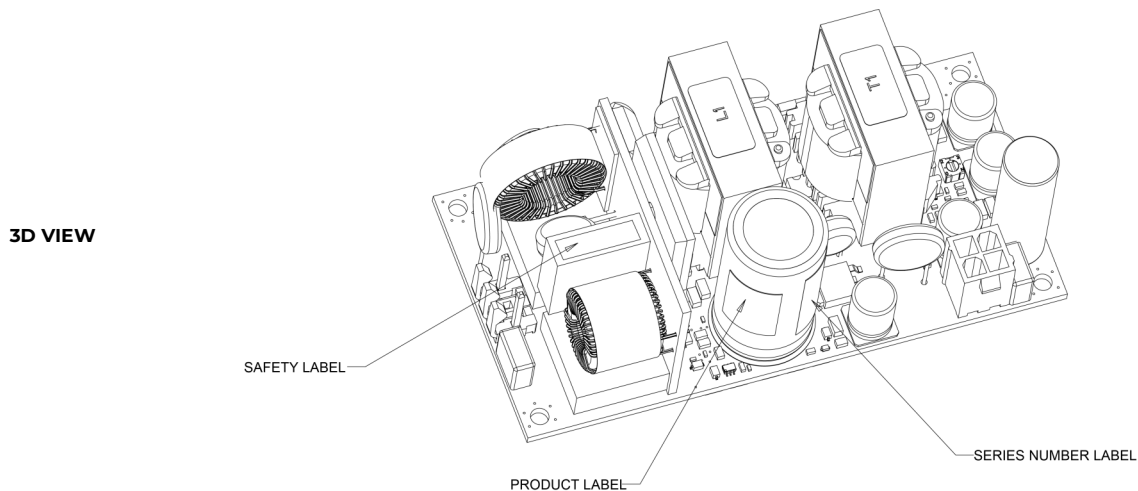

Technical Specifications (continued)

Connector Information

Connector	Connector on Power Supply	Mating Connector
AC Input Connector (HDR1)	Molex 26-50-3030	Molex 09-50-3031
DC Output Connector (HDR2)	Molex 39-28-8040	Molex 39-01-3048
DC Output Connector (HDR2) for Screw output terminal option	TE 282856-2	None needed

Pinout Information

AC Input Connector (HDR1)		DC Output Connector (HDR2) TE 282856-2 option		DC Output Connector (HDR2) Molex 39-28-8040 option	
Pin 1	Neutral	Pins 1	VO	Pin 1	VO
Pin 2	NC (removed)	Pins 2	RTN	Pin 2	VO
Pin 3	Line			Pin 3	RTN
				Pin 4	RTN

Technical Specifications (continued)

Ordering Information

Please contact your OmniOn Sales Representative for pricing, availability and any optional features.

Device Code	Input Voltage Range	Output Voltage	Output Current	Output Connection	Temperature Range
CLP0228FPXXXZ01A	90 – 264V _{ac}	28.0V _{dc}	7.14A	Connector	-40 to 85°C

Table 2. Device Codes.

Contact Us

For more information, call us at

+1-877-546-3243 (US)

+1-972-244-9288 (Int'l)

Change History (excludes grammar & clarifications)

Revision	Date	Description of the change
4.3	11/23/2021	Updated as per template
4.4	03/14/2023	Deleted Obsolete Product
4.5	11/10/2023	Updated as per OmniOn template
4.6	01/04/2024	Updated images in mechanical outline

OmniOn Power Inc.

601 Shiloh Rd.
Plano, TX USA

omnionpower.com

We reserve the right to make technical changes or modify the contents of this document without prior notice. OmniOn Power does not accept any responsibility for errors or lack of information in this document and makes no warranty with respect to and assumes no liability as a result of any use of information in this document.

We reserve all rights in this document and in the subject matter and illustrations contained therein. Any reproduction, disclosure to third parties or utilization of its contents – in whole or in parts – is forbidden without prior written consent of OmniOn Power. This document does not convey license to any patent or any intellectual property right. Copyright© 2023 OmniOn Power Inc. All rights reserved.