

9-36V ProLynx 12A: Non-Isolated DC-DC Power Modules Including -78SRZ Models

9Vdc – 36Vdc input; 3Vdc to 18Vdc output; 12A to 6A Scaled output current

RoHS Compliant



Applications

- Industrial equipment
- Distributed power architectures
- Intermediate bus voltage applications
- Telecommunications equipment

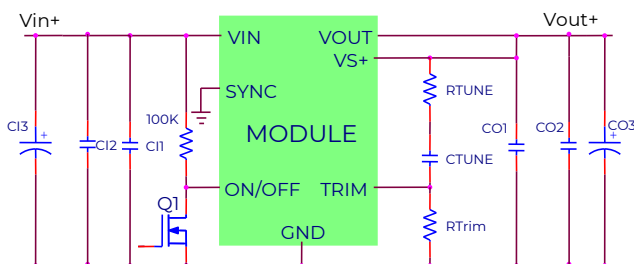

Description

The OmniOn Power™ 9-36V ProLynx series of power modules are non-isolated dc-dc converters that can deliver up to 12A of output current. These modules operate over an extra wide range of input voltage ($V_{IN} = 9Vdc - 36Vdc$) and provide a precisely regulated output voltage from 3Vdc to 18Vdc, programmable via an external resistor. Two new features added with this family of products are the ability to externally tune the voltage control loop and a variable current limit inversely dependent on output voltage. Other features include remote On/Off, adjustable output voltage, over current and overtemperature protection and sync capability. The Ruggedized version (-D) is capable of operation up to 105°C and withstand high levels of shock and vibration. The Tunable Loop™, allows the user to optimize the dynamic response of the converter to match the load with reduced amount of output capacitance leading to savings on cost and PWB area and AutoLimit enables the module to deliver the max possible output power across the entire voltage range. The 9-36V ProLynx can also be used for negative output voltage loads through the use of a specific application schematic.

Features

- Compliant to RoHS Directive 2011/65/EU and amended Directive (EU) 2015/863
- Compliant to REACH Directive (EC) No 1907/2006
- Compatible in a Pb-free or SnPb reflow environment (Z versions)
- Compliant to IPC-9592 (September 2008), Category 2, Class II
- Tunable control loop for fast transient response
- Remote sense
- Optional positive or negative logic remote On/Off
- Output over current protection (non-latching)
- Over temperature protection
- Monotonic startup
- Sync Capability
- Small size and low profile:
33 mm x 13.46 mm x 10 mm (max.)
(1.3 in x 0.53 in x 0.39 in (max.))
- Output voltage programmable from 3 Vdc to 18Vdc via external resistor
- Wide operating temperature range (-40°C to 85°C)
- ANSI/UL* 62368-1 and CAN/CSA† C22.2 No. 62368-1 Recognized, DIN VDE‡ 0868-1/A11:2017 (EN62368-1:2014/A11:2017)
- ISO** 9001 and ISO 14001 certified manufacturing facilities

APXW012 Technical Specifications

Absolute Maximum Ratings

Stresses in excess of the absolute maximum ratings can cause permanent damage to the device. These are absolute stress ratings only, functional operation of the device is not implied at these or any other conditions in excess of those given in the operations sections of the data sheet. Exposure to absolute maximum ratings for extended periods can adversely affect the device reliability.

Parameter	Device	Symbol	Min	Max	Unit
Input Voltage: Continuous	All	V_{IN}	-0.3	37	V
Operating Ambient Temperature (see thermal considerations section)	All	T_A	-40	85	°C
	-D version	T_A	-40	105	°C
Storage Temperature	All	T_{stg}	-55	125	°C

Electrical Specifications

Unless otherwise indicated, specifications apply over all operating input voltage, resistive load, and temperature conditions.

Parameter	Device	Symbol	Min	Typ	Max	Unit
Operating Input Voltage	All	V_{IN}	9	—	36	Vdc
Maximum Input Current ($V_{IN}=9V$ to $36V$, $I_O=I_{O,max}$)	All	$I_{IN,max}$			7	Adc
Input No Load Current ($V_{IN} = 28V$, $I_O = 0$, module enabled)	$V_{O,set} = 3Vdc$ $V_{O,set} = 18Vdc$	$I_{IN,No\ load}$		30		mA
		$I_{IN,No\ load}$		50		mA
Input Stand-by Current ($V_{IN} = 28Vdc$, module disabled)	All	$I_{IN,stand-by}$		3		mA
Inrush Transient	All	I^2t			0.5	A ² s
Input Reflected Ripple Current, peak-to-peak (5Hz to 20MHz, $1\mu H$ source impedance; $V_{IN} = 0$ to $36V$, $I_O = I_{O,max}$; See Test Configurations)	All			125		mAp-p
Input Ripple Rejection (120Hz)	All			-45		dB
Output Voltage Set-point	All	$V_{O,set}$	-1.5		+1.5	% $V_{O,set}$
Output Voltage (Over all operating input voltage, resistive load, and temperature conditions until end of life)	All	V_O	-2.5		+2.5	% $V_{O,set}$
Adjustment Range (elected by an external resistor)(Some output voltages may not be possible depending on the input voltage – see Feature Descriptions Section)	All	V_O	3		18	Vdc
Output Regulation Line ($V_{IN}=V_{IN,min}$ to $V_{IN,max}$) Load ($I_O=I_{O,min}$ to $I_{O,max}$) Temperature ($T_{ref}=T_{A,min}$ to $T_{A,max}$)	All			—	0.4	% $V_{O,set}$
	All			—	0.4	% $V_{O,set}$
	All			1		% $V_{O,set}$
Remote Sense Range	All				0.5	Vdc

CAUTION: This power module is not internally fused. An input line fuse must always be used.

This power module can be used in a wide variety of applications, ranging from simple standalone operation to an integrated part of sophisticated power architecture. To preserve maximum flexibility, internal fusing is not included; however, to achieve maximum safety and system protection, always use an input line fuse. The safety agencies require a fast-acting fuse with a maximum rating of 8 A fast acting (see Safety Considerations section). Based on the information provided in this data sheet on inrush energy and maximum dc input current, the same type of fuse with a lower rating can be used. Refer to the fuse manufacturer's data sheet for further information.

OmniOn Power is a trademark of OmniOn Power Inc. All other trademarks belong to their respective owners.

* UL is a registered trademark of Underwriters Laboratories, Inc.

† CSA is a registered trademark of Canadian Standards Association.

‡ VDE is a trademark of Verband Deutscher Elektrotechniker e.V.

** ISO is a registered trademark of the International Organization of Standards

APXW012 Technical Specifications (continued)

Electrical Specifications (continued)

Parameter	Device	Symbol	Min	Typ	Max	Unit
Input Noise, nominal output, ($V_{IN}=V_{IN, nom}$ and $I_O=I_{O, min}$ to $I_{O, max}$ $C_{IN} = 1x47nF(0306)$ or equivalent, $5x10uF, 50V(1210)$ ceramic capacitors and $470uF, 50V$ (electrolytic), $25^{\circ}C$ Ambient, 500MHz BW	All			3% V_{IN}		
Output Ripple and Noise on nominal output ($V_{IN}=V_{IN, nom}$ and $I_O=I_{O, min}$ to $I_{O, max}$ $C_O = 1x47nF(0306)$ or equivalent, $2x47uF(1210)$ or equivalent ceramic capacitors on output and $1x47nF(0402)$ or equivalent, $5x10uF(1210)$ ceramic capacitors or equivalent and $470uF, 50V$ electrolytic) on input, $25^{\circ}C$ Ambient, 500MHz BW				2.5% V_O		mVpk-pk
Output Ripple and Noise on nominal output ($V_{IN}=V_{IN, nom}$ and $I_O=I_{O, min}$ to $I_{O, max}$ $C_O = 0.1\mu F // 10 \mu F$ ceramic capacitors) $V_{out}=3.3V, V_{IN}=28V$ Peak-to-Peak (5Hz to 20MHz bandwidth) RMS (5Hz to 20MHz bandwidth) $V_{out}=18V, V_{IN}=28V$ Peak-to-Peak (5Hz to 20MHz bandwidth) RMS (5Hz to 20MHz bandwidth)	All All All All			75 20 150 40		mV _{pk-pk} mV _{rms} mV _{pk-pk} mV _{rms}
External Capacitance ¹ Without the Tunable Loop™ ESR $\geq 1 m\Omega$ ESR $\geq 10 m\Omega$ With the Tunable Loop™ ESR $\geq 0.15 m\Omega$ ESR $\geq 10 m\Omega$	All All All All	$C_{O, max}$ $C_{O, max}$ $C_{O, max}$ $C_{O, max}$	0 0 100 0	— — — —	100 1000 250 5000*	μF μF μF μF
Output Current $V_O=3V$ $V_O=5V$ $V_O=12V$ $V_O=18V$	All	I_O I_O I_O I_O	0 0 0 0		12 11.2 8.4 6	Adc Adc Adc Adc
Output Current Limit Inception (Hiccup Mode)	All	$I_{O, lim}$		160		% $I_{O, max}$
Output Short-Circuit Current ($V_O \leq 250mV$) (Hiccup Mode)	All	$I_{O, s/c}$		3		Adc
Efficiency ($I_O=I_{O, max}, V_O=V_{O, set}$) $V_{IN}=12Vdc, T_A=25^{\circ}C$ $V_{IN}=12Vdc, T_A=25^{\circ}C$ $V_{IN}=28Vdc, T_A=25^{\circ}C$ $V_{IN}=28Vdc, T_A=25^{\circ}C$	$V_{O, set} = 3.3Vdc$ $V_{O, set} = 5Vdc$ $V_{O, set} = 12Vdc$ $V_{O, set} = 18Vdc$	η η η η		91.0 93 94 95.5		% % % %
Switching Frequency	All	f_{sw}	—	308	—	kHz
Frequency Synchronization						
Synchronization Frequency Range		f_{sw}			1.1 f _{sw}	kHz
Input high voltage			2			V
Input low voltage					0.8	V
Input Current, SYNC					10	nA
Minimum SYNC Pulse Width			50			ns

¹ Depending on Input and Output Voltage, external capacitors require using the new Tunable Loop™ feature to ensure that the module is stable as well as getting the best transient response. See the Tunable Loop™ section for details.

* Larger values may be possible at specific output voltages. Please consult your OmniOn Power™ Technical representative for additional details.

APXW012 Technical Specifications (continued)

General Specifications

Parameter	Min	Typ	Max	Unit
Calculated MTBF ($I_O=0.8I_{O,max}$, $T_A=40^{\circ}C$) Telcordia Issue 2 Method 1 Case 3		>7,000,000		Hours
Weight	—	7 (0.247)	—	g (oz.)

Feature Specifications

Unless otherwise indicated, specifications apply over all operating input voltage, resistive load, and temperature conditions. See Feature Descriptions for additional information.

Parameter	Device	Symbol	Min	Typ	Max	Unit
On/Off Signal Interface ($V_{IN}=V_{IN,min}$ to $V_{IN,max}$; open collector or equivalent, Signal referenced to GND) Device is with suffix "4" – Positive Logic (See Ordering Information) Logic High (Module ON) Input High Current Input High Voltage Logic Low (Module OFF) Input Low Current Input Low Voltage	All All All All	I_{IH} V_{IH} I_{IL} V_{IL}	— 4.6 — -0.3	— — — —	500 12 0.5 3.3	μA V mA V
Device Code with no suffix – Negative Logic (See Ordering Information) Logic High (Module OFF) Input High Current Input High Voltage Logic Low (Module ON) Input low Current Input Low Voltage	All All All All	I_{IH} V_{IH} I_{IL} V_{IL}	— 1.8 — -0.2	— — — —	3 36 220 0.3	mA Vdc μA Vdc
Turn-On Delay and Rise Times ($V_{IN}=V_{IN,nom}$, $I_O=I_{O,max}$, V_O to within $\pm 1\%$ of steady state) Case 1: On/Off input is enabled and then input power is applied (delay from instant at which $V_{IN} = V_{IN,min}$ until $V_O = 10\%$ of $V_{O,set}$) Case 2: Input power is applied for at least one second and then the On/Off input is enabled (delay from instant at which $V_{on/Off}$ is enabled until $V_O = 10\%$ of $V_{O,set}$) Output voltage Rise time (time for V_O to rise from 10% of $V_{O,set}$ to 90% of $V_{O,set}$)	All All All	Tdelay Tdelay Trise	— — —	12 12 20	— — —	msec msec msec
Output voltage overshoot ($T_A = 25^{\circ}C$ $V_{IN}=V_{IN,min}$ to $V_{IN,max}$, $I_O = I_{O,min}$ to $I_{O,max}$) With or without maximum external capacitance					1	% $V_{O,set}$
Over Temperature Protection (See Thermal Considerations section) Turn-on Threshold Turn-off Threshold Hysteresis	All All All All	T_{ref}		130 8.3 8.2 0.1		$^{\circ}C$ Vdc Vdc Vdc

APXW012 Technical Specifications (continued)

Characteristic Curves

The following figures provide typical characteristics for the 9-36V ProLynx 12A at 3.3Vo and at 25°C.(11.8A rated output)

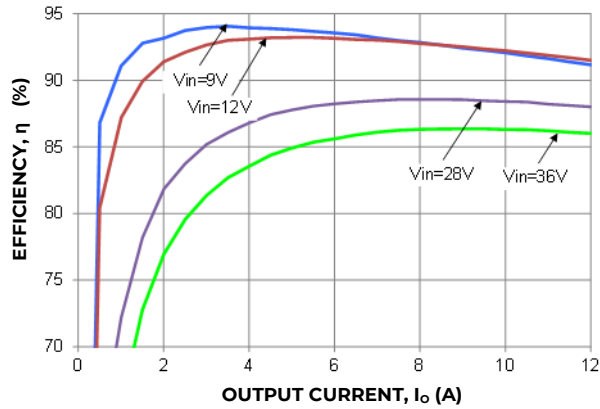

Figure 1. Converter Efficiency versus Output Current.

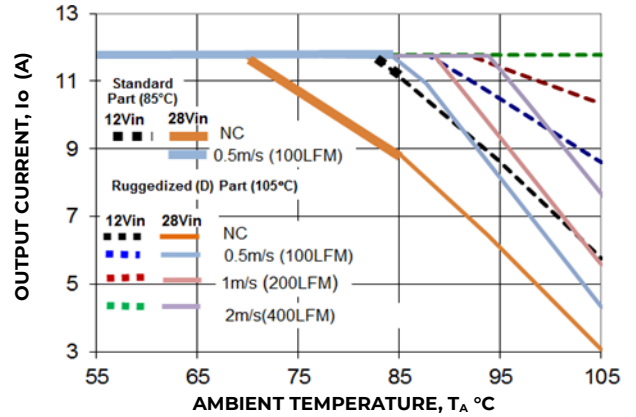

Figure 2. Derating Output Current versus Ambient Temperature and Airflow.

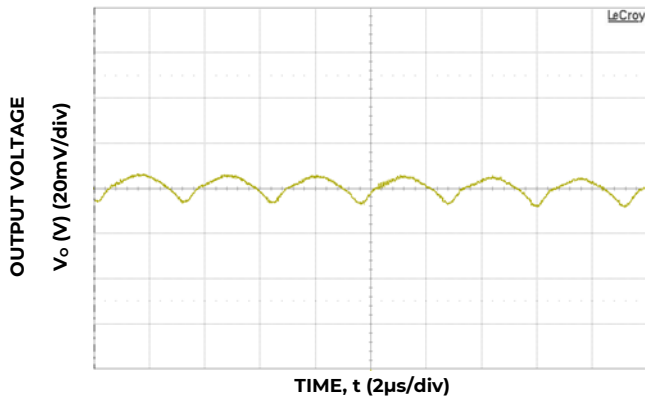

Figure 3. Typical output ripple and noise ($V_{IN} = 28V, I_o = I_{o,max}$).

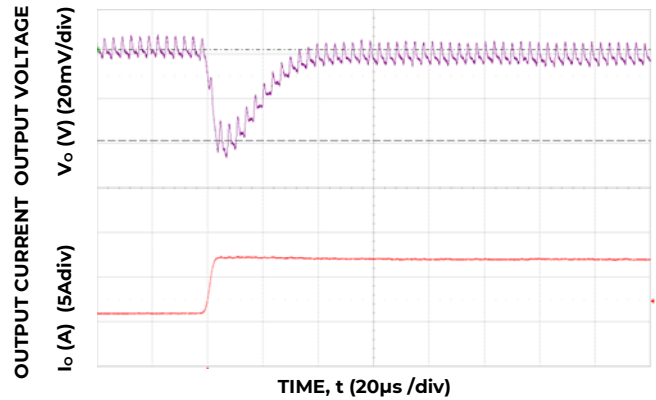

Figure 4. Transient Response to Dynamic Load Change from 50% to 100% at 28Vin, $C_{ext} = 2x22\mu F + 2x330\mu F, C_{Tune} = 15nF$ & $R_{Tune} = 200\Omega$.

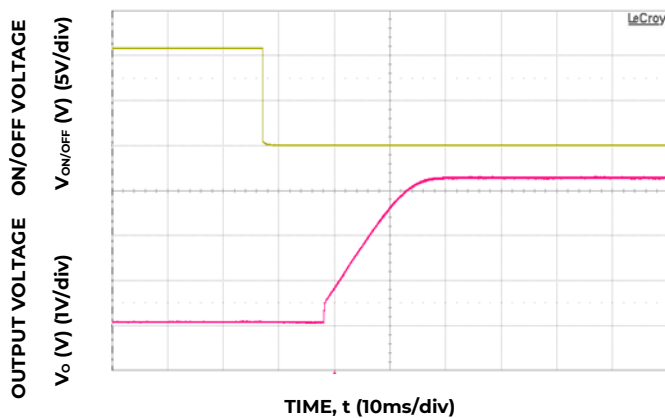

Figure 5. Typical Start-up Using On/Off Voltage ($I_o = I_{o,max}$).

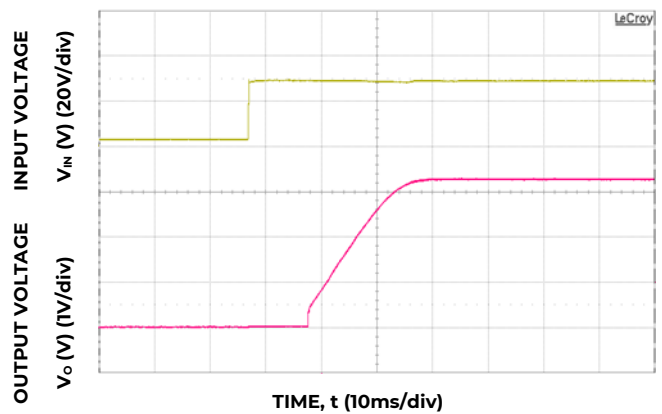

Figure 6. Typical Start-up Using Input Voltage ($V_{IN} = 28V, I_o = I_{o,max}$).

APXW012 Technical Specifications (continued)

Characteristic Curves (continued)

The following figures provide typical characteristics for the 9-36V ProLynx 12A at 5 Vo and at 25°C.(11.2A rated output)

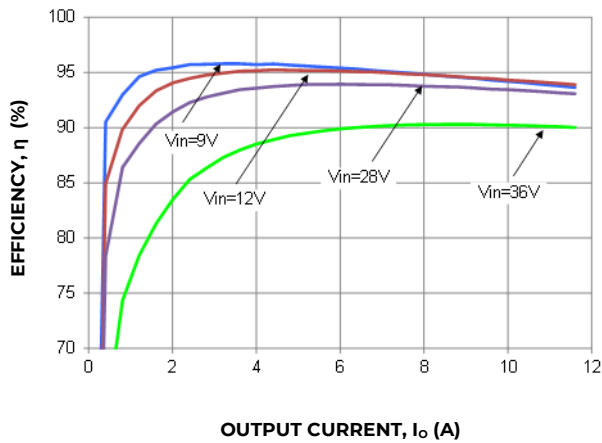

Figure 7. Converter Efficiency versus Output Current.

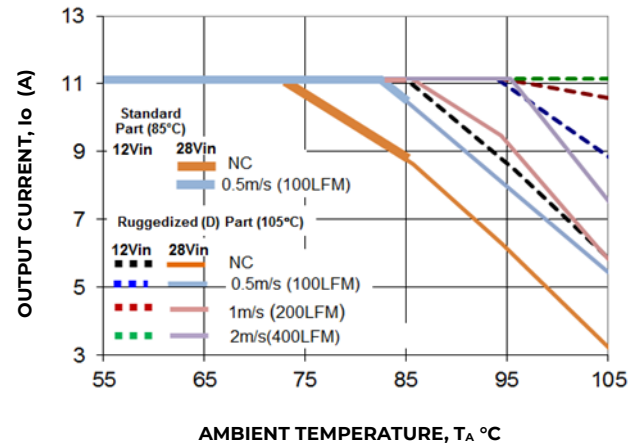

Figure 8. Derating Output Current versus Ambient Temperature and Airflow.

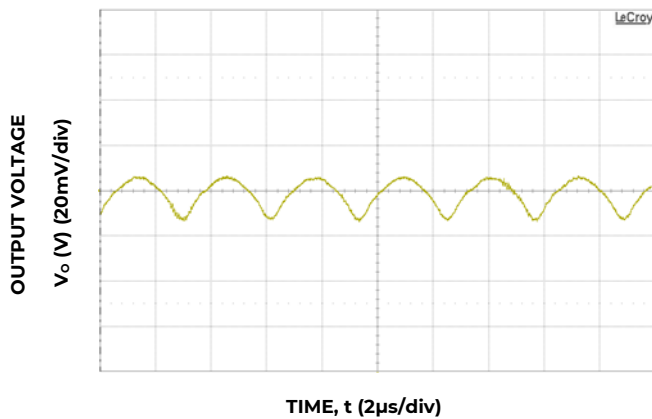

Figure 9. Typical output ripple and noise ($V_{IN} = 28V, I_o = I_{o,max}$).

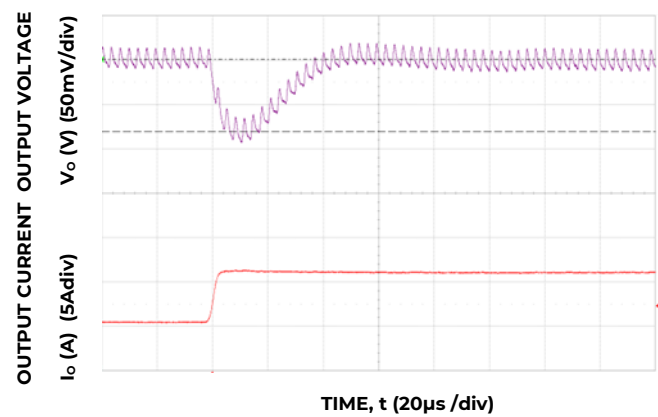

Figure 10. Transient Response to Dynamic Load Change from 50% to 100% at 28Vin, $C_{ext} = 1X22\mu F + 1x330\mu F, C_{Tune} = 5.6nF$ & $R_{Tune} = 200$.

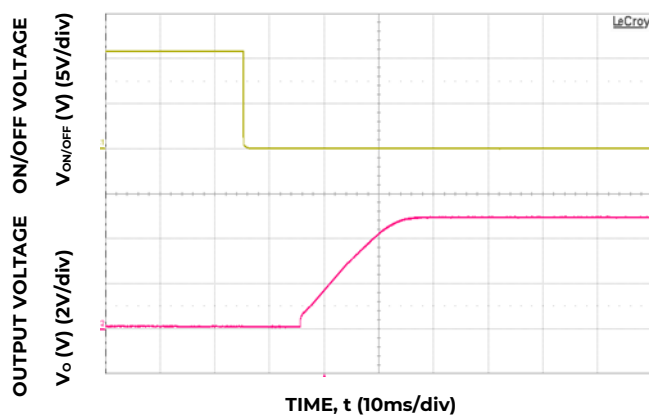

Figure 11. Typical Start-up Using On/Off Voltage ($I_o = I_{o,max}$).

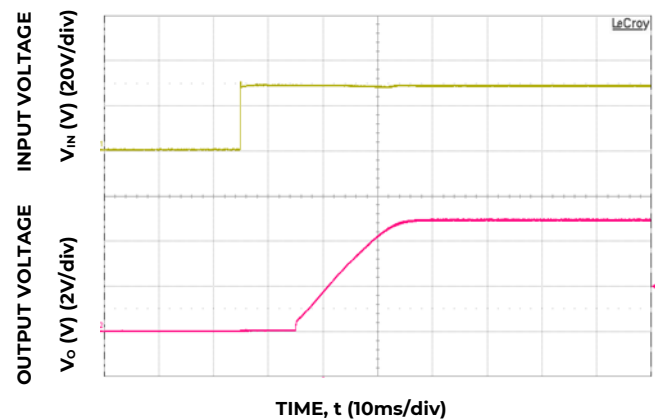

Figure 12. Typical Start-up Using Input Voltage ($V_{IN} = 28V, I_o = I_{o,max}$).

APXW012 Technical Specifications (continued)

Characteristic Curves (continued)

The following figures provide typical characteristics for the 9-36V ProLynx 12A at 12Vo and at 25°C.(8.4A rated output)

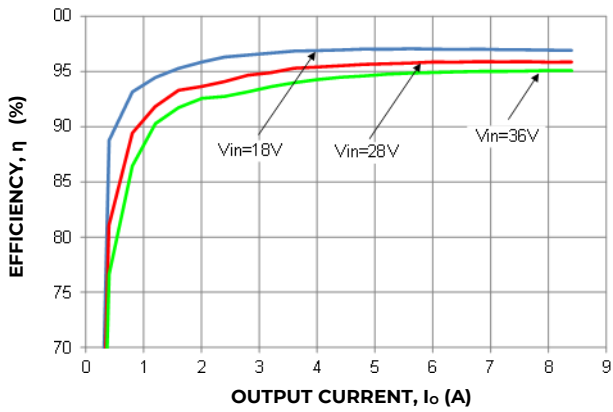

Figure 13. Converter Efficiency versus Output Current.

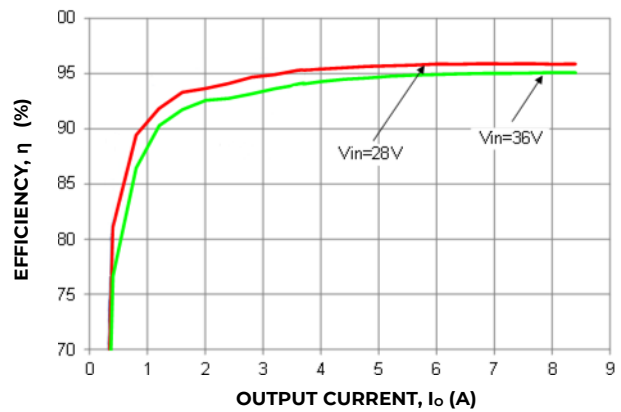

Figure 14. Converter Efficiency versus Output Current. (-78 Version)

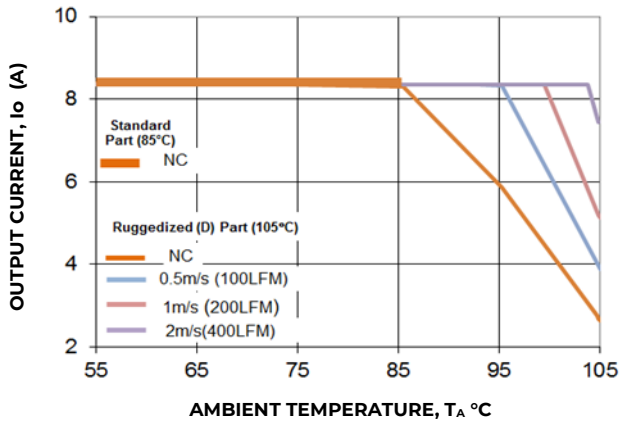

Figure 15. Derating Output Current versus Ambient Temperature and Airflow.

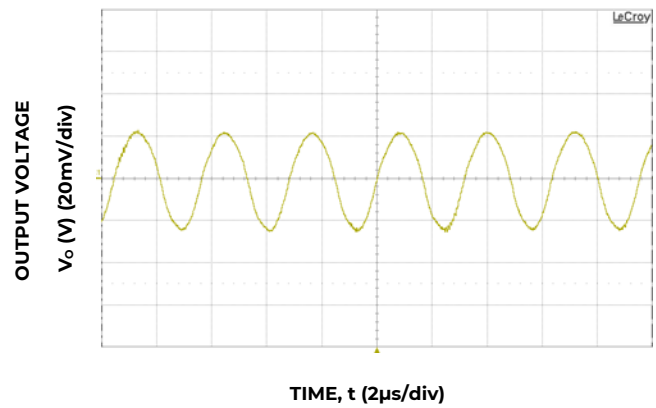

Figure 16. Typical output ripple and noise (VIN = 28V, Io = Io,max).

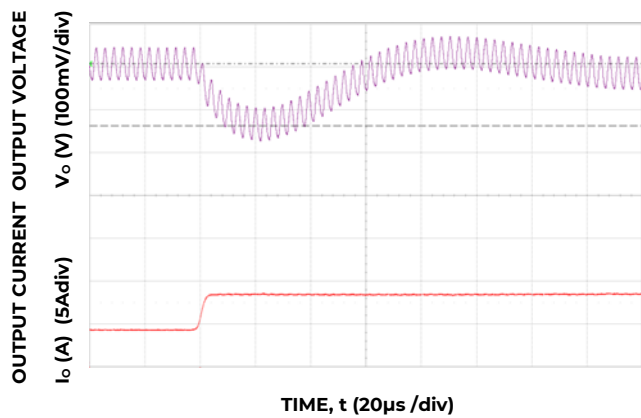

Figure 17. Transient Response to Dynamic Load Change from 50% to 100% at 28Vin, Cext = 1x22µF+1x470µF, CTune=1.5nF & RTune=200

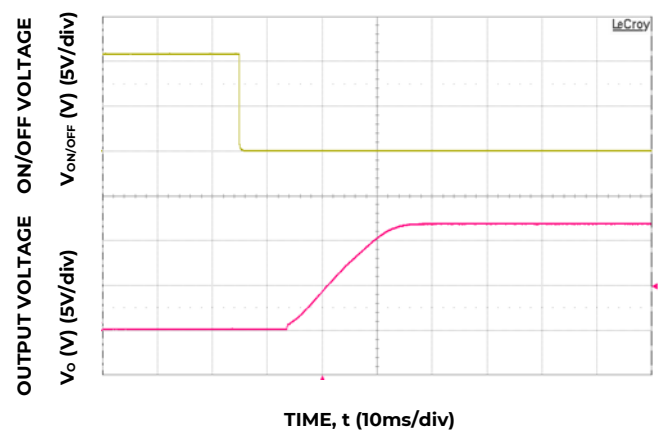

Figure 18. Typical Start-up Using On/Off Voltage (Io = Io,max).

APXW012 Technical Specifications (continued)

Characteristic Curves (continued)

The following figures provide typical characteristics for the 9-36V ProLynx 12A at 18Vo and at 25°C.(6A rated output)

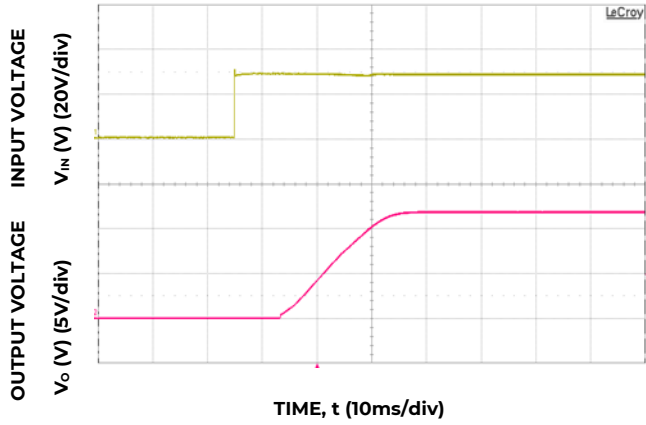

Figure 19. Typical Start-up Using Input Voltage ($V_{IN} = 28V$, $I_o = I_{o,max}$).

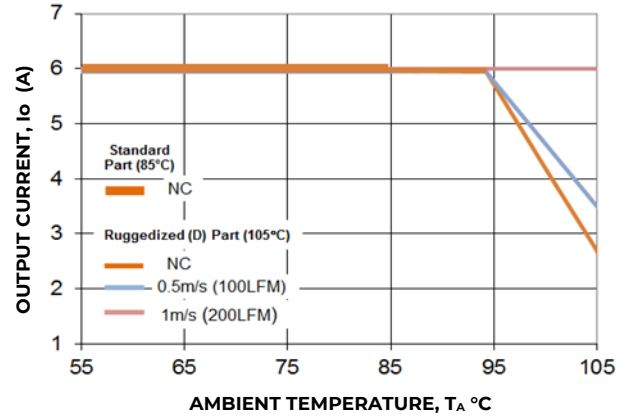

Figure 20. Derating Output Current versus Ambient Temperature and Airflow.

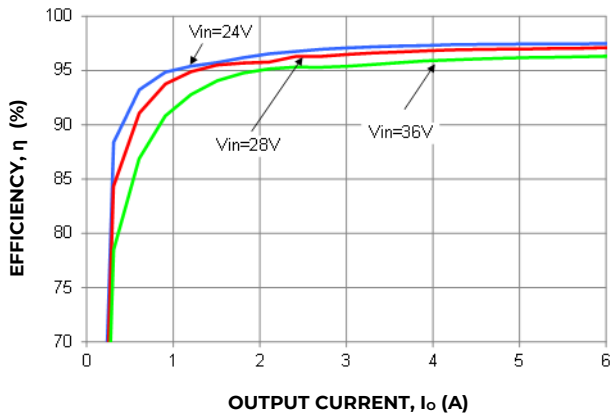

Figure 21. Converter Efficiency versus Output Current.

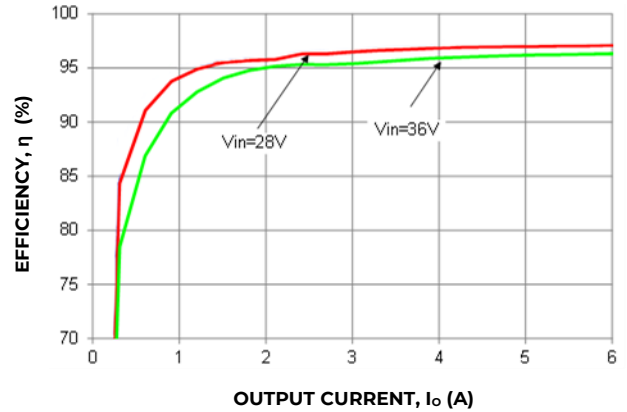

Figure 22. Converter Efficiency versus Output Current. (-78 Version)

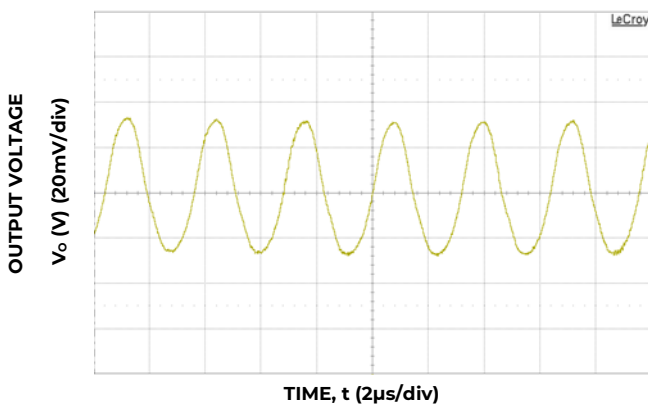

Figure 23. Typical output ripple and noise ($V_{IN} = 28V$, $I_o = I_{o,max}$).

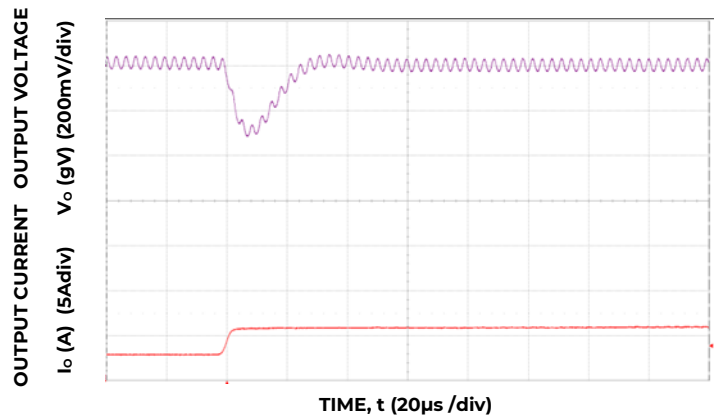

Figure 24. Transient Response to Dynamic Load Change from 50% to 100% at 28Vin, Cext - 1x10uF ceramic CTune=Open & RTune=Open.

APXW012 Technical Specifications (continued)

Characteristic Curves (continued)

The following figures provide typical characteristics for the 9-36V ProLynx 12A at 18V_o and at 25°C.(6A rated output)

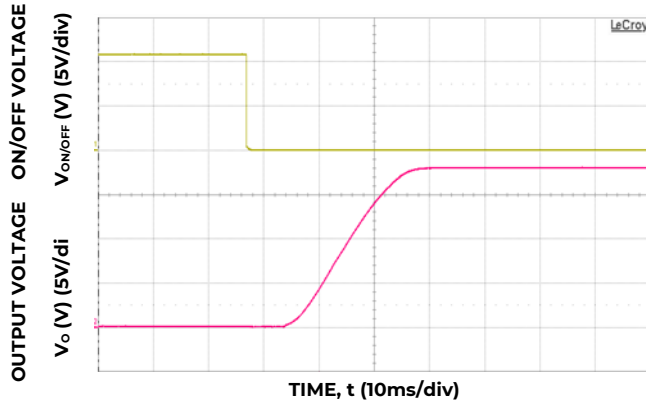

Figure 25. Typical Start-up Using On/Off Voltage
(I_o = I_{o,max}).

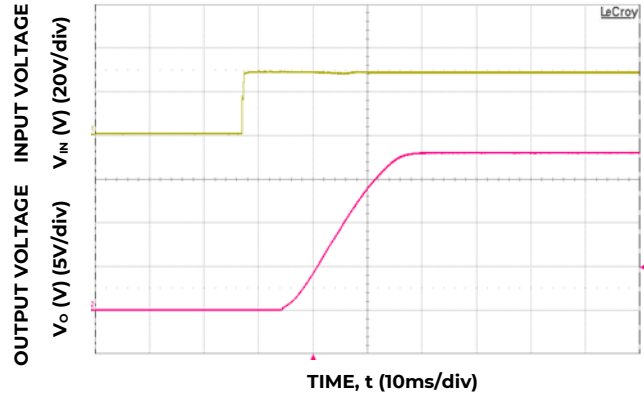
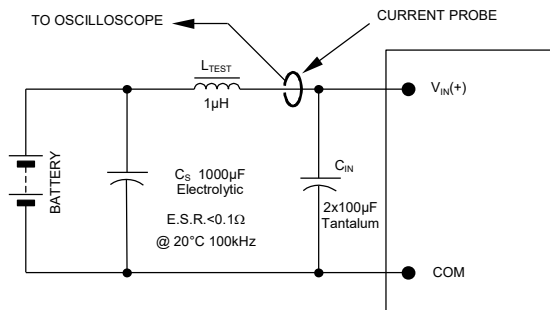

Figure 26. Typical Start-up Using Input Voltage
(V_{IN} = 28V, I_o = I_{o,max}).

Test Configurations



NOTE: Measure input reflected ripple current with a simulated source inductance (L_{TEST}) of 1µH. Capacitor C_S offsets possible battery impedance. Measure current as shown above.

Figure 27. Input Reflected Ripple Current Test Setup.

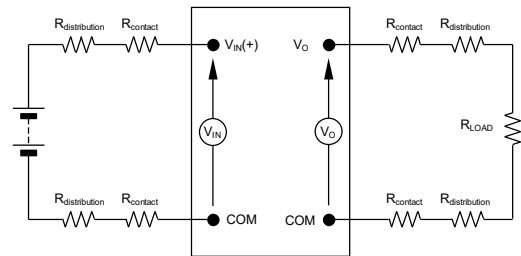

NOTE: All voltage measurements to be taken at the module terminals, as shown above. If sockets are used then Kelvin connections are required at the module terminals to avoid measurement errors due to socket contact resistance.

Figure 29. Output Voltage and Efficiency Test Setup.

$$\text{Efficiency } \eta = \frac{V_o \cdot I_o}{V_{IN} \cdot I_{IN}} \times 100 \%$$

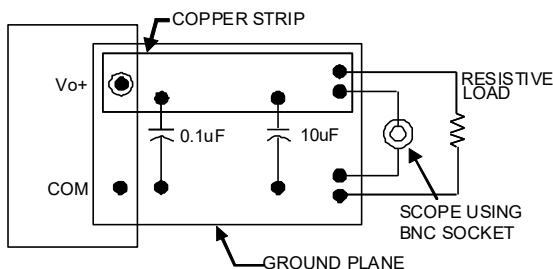

NOTE: All voltage measurements to be taken at the module terminals, as shown above. If sockets are used then Kelvin connections are required at the module terminals to avoid measurement errors due to socket contact resistance.

Figure 28. Output Ripple and Noise Test Setup.

Design Considerations

Input Filtering

The 9-36V ProLynx module should be connected to a low ac-impedance source. A highly inductive source can affect the stability of the module. An input capacitance must be placed directly adjacent to the input pin of the module, to minimize input ripple voltage and ensure module stability.

To minimize input voltage ripple, ceramic capacitors are recommended at the input of the module. Figure 30 and 31 shows the input ripple voltage for various output voltages at maximum load current with 3x10 µF or 4x10 µF ceramic capacitors and an input of 12V while Figure 32 shows the input ripple for an input voltage of 28V.

APXW012 Technical Specifications (continued)

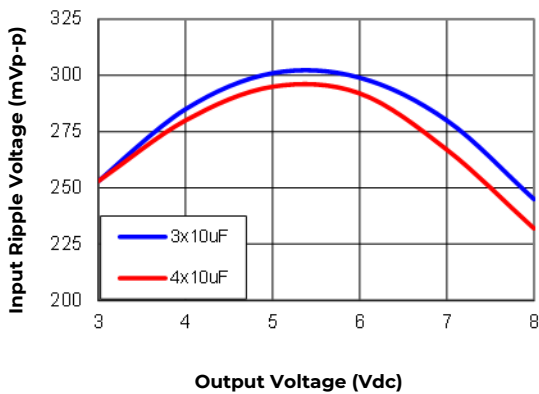

Figure 30. Input ripple voltage for various output voltages with 3x10 μ F or 4x10 μ F ceramic capacitors at the input (maximum load). Input voltage is 12V. Scope BW at 20MHz

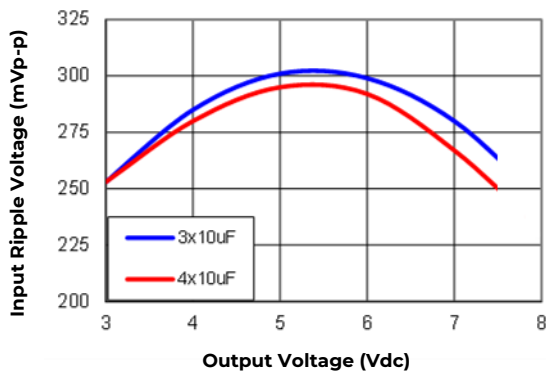

Figure 31. Input ripple voltage for various output voltages with 3x10 μ F or 4x10 μ F ceramic capacitors at the input (maximum load). Input voltage is 12V. Scope BW at 20MHz (-78 Version)

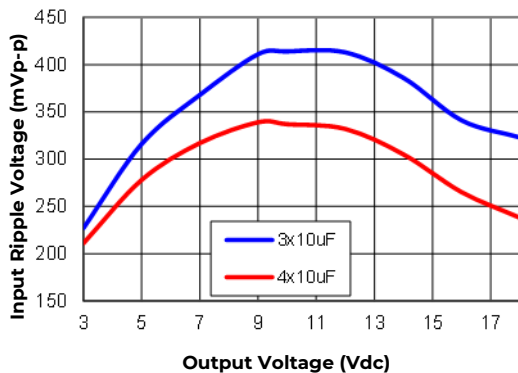

Figure 32. Input ripple voltage for various output voltages with 3x10 μ F or 4x10 μ F ceramic capacitors at the input (maximum load). Input voltage is 28V. Scope BW at 20MHz

Output Filtering

The 9-36V ProLynx modules are designed for low output ripple voltage and will meet the maximum output ripple specification with 0.047 μ F ceramic and 22 μ F ceramic capacitors at the output of the module. However, additional output filtering may be required by the system designer for a number of reasons. First, there may be a need to further reduce the output ripple and noise of the module. Second, the dynamic response characteristics may need to be customized to a particular load step change.

To reduce the output ripple and improve the dynamic response to a step load change, additional capacitance at the output can be used. Low ESR polymer and ceramic capacitors are recommended to improve the dynamic response of the module. Figures 33, 34 and 35 provides output ripple information for different external capacitance values at various V_o and for full load currents. For stable operation of the module, limit the capacitance to less than the maximum output capacitance as specified in the electrical specification table. Optimal performance of the module can be achieved by using the Tunable Loop™ feature described later in this data sheet.

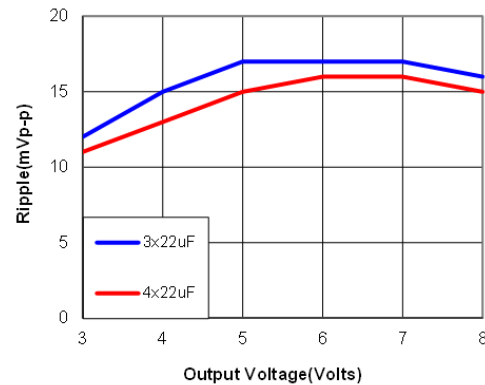

Figure 33. Output ripple with external 3x22 μ F or 4x22 μ F ceramic capacitors at the output (max. load). Input voltage is 12V. Scope BW at 20MHz

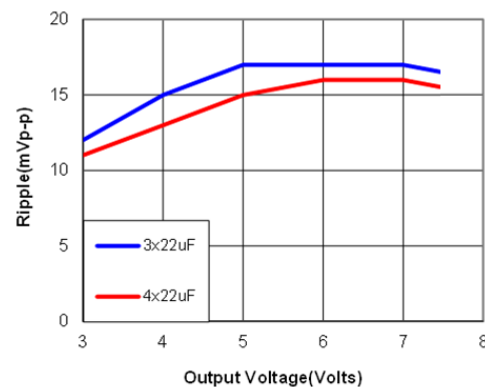

Figure 34. Output ripple with external 3x22 μ F or 4x22 μ F ceramic capacitors at the output (max. load). Input voltage is 12V. Scope BW at 20MHz. (-78 Version)

APXW012 Technical Specifications (continued)

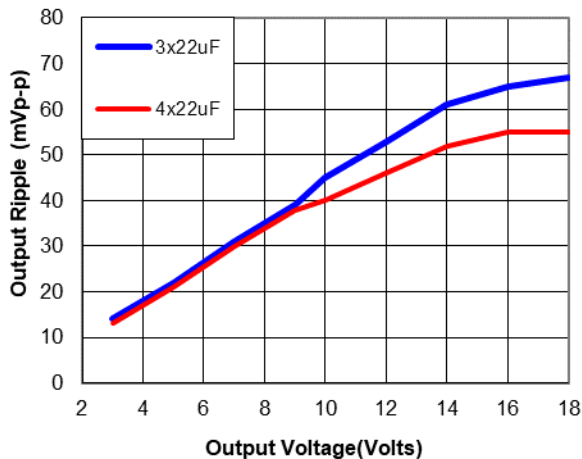

Figure 35. Output ripple voltage with external 3x22 μ F or 4x22 μ F ceramic capacitors at the output (max. load). Input voltage is 28V. Scope BW 20MHz.

Safety Considerations

For safety agency approval the power module must be installed in compliance with the spacing and separation requirements of the end-use safety agency standards, i.e., UL ANSI/UL* 62368-1 and CAN/CSA+C22.2 No. 62368-1 Recognized, DIN VDE 0868-1/A11:2017 (EN62368-1:2014/A11:2017)

For the converter output to be considered meeting the requirements of safety extra-low voltage (SELV) or ES1, the input must meet SELV/ES1 requirements. The power module has extra-low voltage (ELV) outputs when all inputs are ELV.

The input to these units is to be provided with a fast-acting fuse with a maximum rating of 8A in the positive input lead.

Feature Descriptions

Remote Enable

The 9-36V ProLynx modules feature an On/Off pin for remote On/Off operation. Two On/Off logic options are available. In the Positive Logic On/Off option, (device code suffix "4" – see Ordering Information), the module turns ON during a logic High on the On/Off pin and turns OFF during a logic Low. With the Negative Logic On/Off option, (no device code suffix, see Ordering Information), the module turns OFF during logic High and ON during logic Low. The On/Off signal is always referenced to ground.

For positive logic modules, the circuit configuration for using the On/Off pin is shown in Figure 36. When the external transistor Q1 is in the OFF state, the ON/OFF pin is pulled high and transistor Q2 is OFF leading to Q3 also being OFF which turns the module ON.

The external resistor R_{pullup} (100k recommended) must be sized so that $V_{ON/OFF}$ is never more than 12V when Q1 is OFF. In particular, if V_{pullup} is made the same as the input voltage V_{in} , the resistor R_{pullup} must be large enough so that $V_{ON/OFF}$ is never more than 12V. If the On/Off pin is left floating the module will be in the ON state.

For negative logic On/Off modules, the circuit configuration is shown in Figure 37. When the external transistor Q1 is in the ON state, the ON/OFF pin is pulled low causing transistor Q2 to be OFF and the module to be turned ON. To turn the module OFF, Q1 is turned OFF, causing the ON/OFF pin to be pulled high turning Q2 ON and the module to be turned OFF. If the On/Off pin is left floating, the module will be in the ON state.

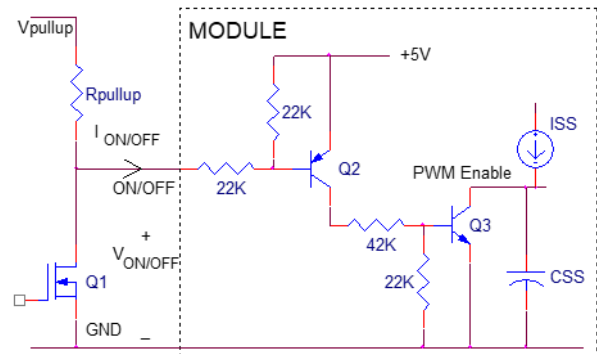

Figure 36. Circuit configuration for using positive On/Off logic.

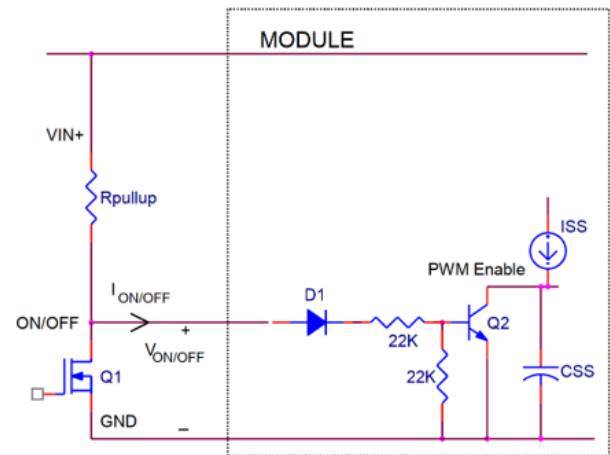

Figure 37. Circuit configuration for using negative On/Off logic.

APXW012 Technical Specifications (continued)

Overcurrent Protection

To provide protection in a fault (output overload) condition, the unit is equipped with internal current limiting circuitry and can endure current limiting continuously. At the point of current-limit inception, the unit enters hiccup mode. The unit operates normally once the output current is brought back into its specified range. The 9-36V ProLynx modules employ an innovative, patent pending, 'AutoLimit' capability. This results in automatic scaling of current limit with output voltage through an inverse relationship of the current limit threshold with the output voltage. This feature shown graphically in Figure 38, allows higher output currents to be drawn from the module at lower output voltages thereby optimizing the power delivery capability of the module.

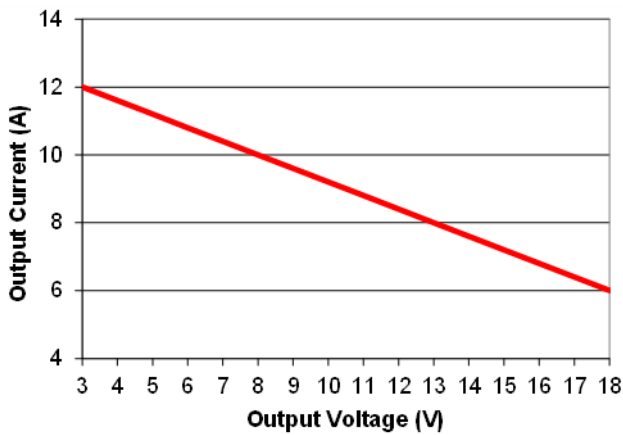

Figure 38. Graph showing maximum output current capability at different output voltages.

Over Temperature Protection

To provide protection in a fault condition, the unit is equipped with a thermal shutdown circuit. The unit will shutdown if the overtemperature threshold of 130 °C is exceeded at the thermal reference point T_{ref} . The thermal shutdown is not intended as a guarantee that the unit will survive temperatures beyond its rating. Once the unit goes into thermal shutdown it will then wait to cool before attempting to restart.

Input Undervoltage Lockout

At input voltages below the input undervoltage lockout limit, the module operation is disabled. The module will begin to operate at an input voltage above the under voltage lockout turn-on threshold.

Output Voltage Programming

The output voltage of the 9-36V ProLynx module can be programmed to any voltage from 3Vdc to 18Vdc by connecting a resistor between the Trim and GND pins of the module. Certain restrictions apply on the output voltage set point depending on the input voltage. These are shown in the Output Voltage vs. Input Voltage Set Point Area plot in Figure 35 and 36.

Without an external resistor between Trim and GND pins, the output of the module will be 0.7Vdc. To calculate the value of the trim resistor, R_{trim} for a desired output voltage, use the following equation:

$$R_{trim} = \left[\frac{70}{(V_o - 0.7)} \right] k\Omega$$

R_{trim} is the external resistor in $k\Omega$, and V_o is the desired output voltage.

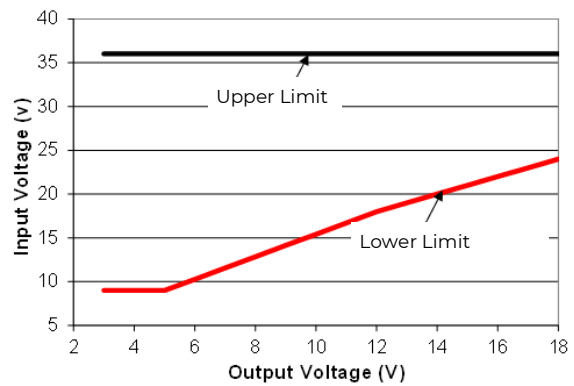

Figure 39. Output Voltage vs. Input Voltage Set Point Area plot showing limits where the output voltage can be set for different input voltages.

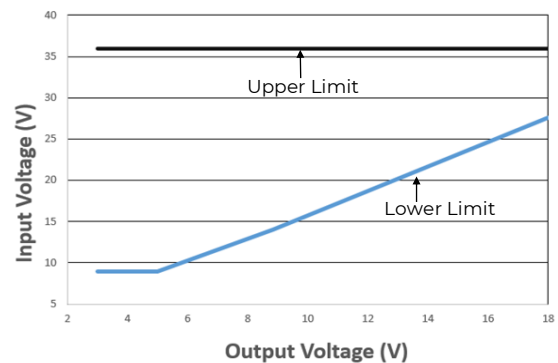

Figure 40. Output Voltage vs. Input Voltage Set Point Area plot showing limits where the output voltage can be set for different input voltages. (-78 Version)

APXW012 Technical Specifications (continued)

V _{IN} (V)	V _{OUT} min (V)	V _{OUT} max (V)
9	3.00	5.00
10	3.00	5.77
11	3.00	6.54
12	3.00	7.31
13	3.00	8.08
14	3.00	8.85
15	3.00	9.53
16	3.00	10.20
17	3.00	10.87
18	3.00	11.55
19	3.00	12.22
20	3.00	12.90
21	3.00	13.57
22	3.00	14.25
23	3.00	14.92
24	3.00	15.60
25	3.00	16.27
26	3.00	16.95
27	3.00	17.62
28	3.00	18.00
29	3.00	18.00
30	3.00	18.00
31	3.00	18.00
32	3.00	18.00
33	3.00	18.00
34	3.00	18.00
35	3.00	18.00
36	3.00	18.00

Table 1 provides R_{trim} values required for some common output voltages.

Table 1

V _{o, set} (V)	R _{trim} (KΩ)
3.3	26.92
5	16.27
6	13.2
9	8.43
12	6.19
15	4.89
18	4.04

By using a ±0.5% tolerance trim resistor with a TC of ±100ppm, a set point tolerance of ±1.5% can be achieved as specified in the electrical specification.

Remote Sense

The 9-36V ProLynx power modules have a Remote Sense feature to minimize the effects of distribution losses by regulating the voltage between the VS+ and Vo pin. The voltage between the VS+ pin and Vo pin will not exceed 0.5V.

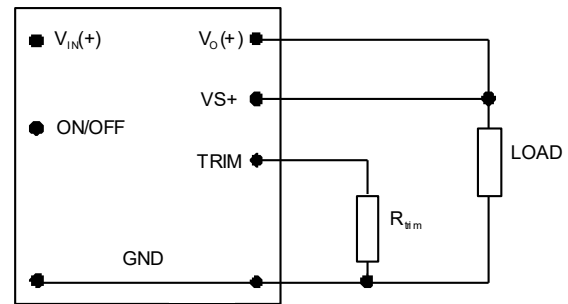

Figure 41. Circuit configuration for programming output voltage using an external resistor.

Voltage Margining

Output voltage margining can be implemented in the 9-36V ProLynx modules by connecting a resistor, R_{margin-up}, from the Trim pin to the ground pin for margining-up the output voltage and by connecting a resistor, R_{margin-down}, from the Trim pin to output pin for margining-down. Figure 42 shows the circuit configuration for output voltage margining. The POL Programming Tool, available at omnionpower.com under the Design Tools section, also calculates the values of R_{margin-up} and R_{margin-down} for a specific output voltage and % margin. Please consult your local OmniOn Power™ technical representative for additional details.

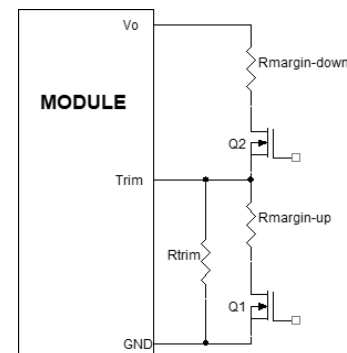

Figure 42. Circuit Configuration for margining Output voltage

Synchronization

The module switching frequency can be synchronized to a signal with an external frequency within a specified range. Synchronization can be done by using the external signal applied to the SYNC pin of the module as shown in Figure 43, with the converter being synchronized by the rising edge of the external signal. The Electrical Specifications table specifies the requirements of the external SYNC signal. If the SYNC pin is not used, the module should free run at the default switching frequency. **If synchronization is not being used, connect the SYNC pin to GND.**

APXW012 Technical Specifications (continued)

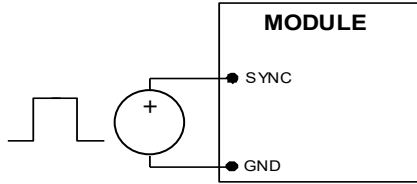

Figure 43. External source connections to synchronize switching frequency of the module.

Tunable Loop™

The 9-36V ProLynx modules have a new feature that optimizes transient response of the module called Tunable Loop™.

External capacitors are usually added to the output of the module for two reasons: to reduce output ripple and noise (see Figures 33, 34 and 35) and to reduce output voltage deviations from the steady-state value in the presence of dynamic load current changes. Adding external capacitance however affects the voltage control loop of the module, typically causing the loop to slow down with sluggish response. Larger values of external capacitance could also cause the module to become unstable.

The Tunable Loop™ allows the user to externally adjust the voltage control loop to match the filter network connected to the output of the module. The Tunable Loop™ is implemented by connecting a series R-C between the VS+ and TRIM pins of the module, as shown in Figure 44. This R-C allows the user to externally adjust the voltage loop feedback compensation of the module.

Recommended values of R_{TUNE} and C_{TUNE} for different output capacitor combinations are given in Tables 2, 3 and 4. Tables 2 and 3 show recommended values of R_{TUNE} and C_{TUNE} for different values of ceramic output capacitors up to 100µF that might be needed for an application to meet output ripple and noise requirements. Selecting R_{TUNE} and C_{TUNE} according to Tables 2 and 3 will ensure stable operation of the module

In applications with tight output voltage limits in the presence of dynamic current loading, additional output capacitance will be required. Table 4 lists recommended values of R_{TUNE} and C_{TUNE} in order to meet 2% output voltage deviation limits for some common output voltages in the presence of a 50% of full load step change with an input voltage of 12 or 28V.

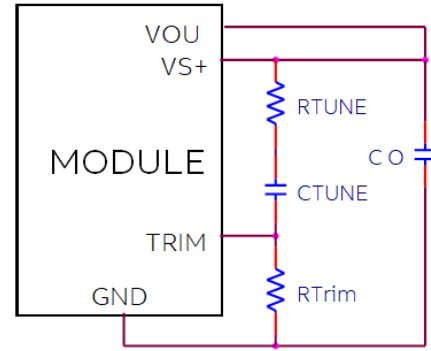

Figure 44. Circuit diagram showing connection of R_{TUNE} and C_{TUNE} to tune the control loop of the module.

Please contact your OmniOn Power™ technical representative to obtain more details of this feature as well as for guidelines on how to select the right value of external R-C to tune the module for best transient performance and stable operation for other output capacitance values or input voltages other than 12V/28V

Table 2. General recommended values of R_{TUNE} and C_{TUNE} for $V_{in}=12V$ and various external ceramic capacitor combinations.

$V_o=5V$

C_o	5x22µF	6x22µF	7x22µF	8x22µF	10x22µF
R_{TUNE}	300	300	240	240	240
C_{TUNE}	2700p	3300p	3900p	4700p	6800p

Table 3. General recommended values of R_{TUNE} and C_{TUNE} for $V_{in}=28V$ and various external ceramic capacitor combinations.

$V_o=5V$

C_o	5x22µF	6x22µF	7x22µF	8x22µF	10x22µF
R_{TUNE}	300	300	240	240	240
C_{TUNE}	1800p	2200p	3900p	3300p	3900p

$V_o=12V$

C_o	5x22µF	6x22µF	7x22µF	8x22µF	10x22µF
R_{TUNE}	300	300	300	300	240
C_{TUNE}	560p	820p	1000p	1200p	1800p

Table 4. Recommended values of R_{TUNE} and C_{TUNE} to obtain transient deviation of 2% of V_{out} for a 50% of full load step

V_{in}	12V		28V			
	V_o	ΔI	V_o	ΔI	V_o	ΔI
	3.3V	6A	3.3V	6A	5V	5.5A
	5V	5.5A	5V	5.5A	12V	4.2
			12V		18V	3A
C_o	2x22uF +	1x22uF +	2x22uF +	1x22uF +	1x22uF +	5x22uF
	2x330uF	1x330uF	2x330uF	1x330uF	1x470uF	
R_{TUNE} (Ω)	200	200	200	200	200	200
C_{TUNE}	22nF	12nF	15nF	5.6nF	1.5nF	220pF
ΔV	50mV	72mV	33mV	58mV	79mV	247mV

9 mohm POSCAP 330uF-6TPF330M9L

25 mohm Nichicon 470uF, 16V

22uF, 25Vrated Ceramic Cap - GRM32ER71E226KE15L

APXW012 Technical Specifications (continued)

Thermal Considerations

Power modules operate in a variety of thermal environments; however, sufficient cooling should always be provided to help ensure reliable operation.

Considerations include ambient temperature, airflow, module power dissipation, and the need for increased reliability. A reduction in the operating temperature of the module will result in an increase in reliability. The thermal data presented here is based on physical measurements taken in a wind tunnel. The test set-up is shown in Figure 45. The preferred airflow direction for the module is in Figure 46. The derating data applies to airflow in either direction of the module's short axis.

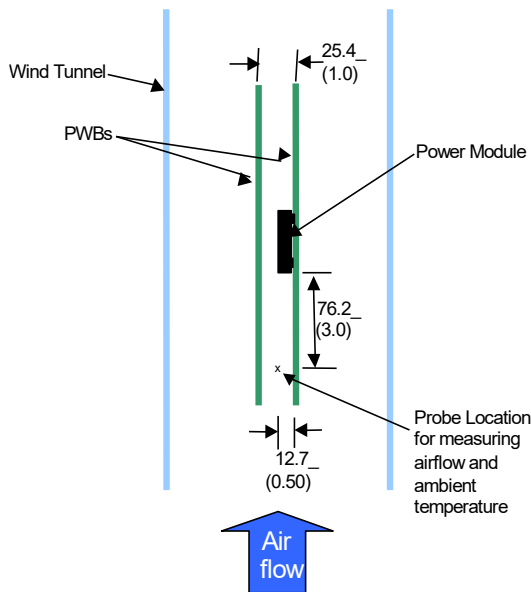

Figure 45. Thermal Test Setup.

The thermal reference points, T_{ref} used in the specifications are also shown in Figure 46. For reliable operation the temperatures at these points should not exceed 118°C. The output power of the module should not exceed the rated power of the module ($V_{o,set} \times I_{o,max}$).

Please refer to the Application Note “Thermal Characterization Process For Open-Frame Board-Mounted Power Modules” for a detailed discussion of thermal aspects including maximum device temperatures.

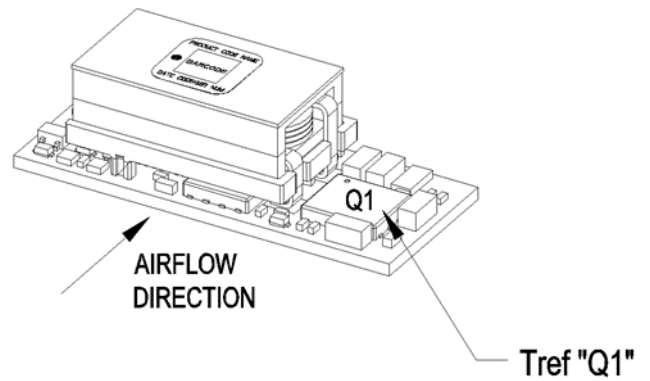

Figure 46. Preferred airflow direction and location of hot-spot of the module (T_{ref}).

APXW012 Technical Specifications (continued)

Shock and Vibration

The ruggedized (-D version) of the modules are designed to withstand elevated levels of shock and vibration to be able to operate in harsh environments. The ruggedized modules have been successfully tested to the following conditions:

Non operating random vibration:

Random vibration tests conducted at 25C, 10 to 2000Hz, for 30 minutes each level, starting from 30Grms (Z axis) and up to 50Grms (Z axis). The units were then subjected to two more tests of 50Grms at 30 minutes each for a total of 90 minutes.

Operating shock to 40G per Mil Std. 810G, Method 516.4 Procedure I:

The modules were tested in opposing directions along each of three orthogonal axes, with waveform and amplitude of the shock impulse characteristics as follows:

All shocks were half sine pulses, 11 milliseconds (ms) in duration in all 3 axes.

Units were tested to the Functional Shock Test of MIL-STD-810, Method 516.4, Procedure I - Figure 516.4-4. A shock magnitude of 40G was utilized. The operational units were subjected to three shocks in each direction along three axes for a total of eighteen shocks.

Operating vibration per Mil Std 810G, Method 514.5 Procedure I:

The ruggedized (-D version) modules are designed and tested to vibration levels as outlined in MIL-STD-810G, Method 514.5, and Procedure 1, using the Power Spectral Density (PSD) profiles as shown in Table 1 and Table 2 for all axes. Full compliance with performance specifications was required during the performance test. No damage was allowed to the module and full compliance to performance specifications was required when the endurance environment was removed. The module was tested per MIL-STD-810, Method 514.5, Procedure I, for functional (performance) and endurance random vibration using the performance and endurance levels shown in Table 5 and Table 6 for all axes. The performance test has been split, with one half accomplished before the endurance test and one half after the endurance test (in each axis). The duration of the performance test was at least 16 minutes total per axis and at least 120 minutes total per axis for the endurance test. The endurance test period was 2 hours minimum per axis.

Table 5: Performance Vibration Qualification - All Axes

Frequency (Hz)	PSD Level (G ² /Hz)	Frequency (Hz)	PSD Level (G ² /Hz)	Frequency (Hz)	PSD Level (G ² /Hz)
10	1.14E-03	170	2.54E-03	690	1.03E-03
30	5.96E-03	230	3.70E-03	800	7.29E-03
40	9.53E-04	290	7.99E-04	890	1.00E-03
50	2.08E-03	340	1.12E-02	1070	2.67E-03
90	2.08E-03	370	1.12E-02	1240	1.08E-03
110	7.05E-04	430	8.84E-04	1550	2.54E-03
130	5.00E-03	490	1.54E-03	1780	2.88E-03
140	8.20E-04	560	5.62E-04	2000	5.62E-04

Table 6: Endurance Vibration Qualification - All Axes

Frequency (Hz)	PSD Level (G ² /Hz)	Frequency (Hz)	PSD Level (G ² /Hz)	Frequency (Hz)	PSD Level (G ² /Hz)
10	0.00803	170	0.01795	690	0.00727
30	0.04216	230	0.02616	800	0.05155
40	0.00674	290	0.00565	890	0.00709
50	0.01468	340	0.07901	1070	0.01887
90	0.01468	370	0.07901	1240	0.00764
110	0.00498	430	0.00625	1550	0.01795
130	0.03536	490	0.01086	1780	0.02035
140	0.0058	560	0.00398	2000	0.00398

APXW012 Technical Specifications (continued)

Example Application Circuit

Requirements:

- Vin: 28V
- Vout: 12V
- Iout: 6.3A max., worst case load transient is from 1A to 1.5A
- ΔV_{out} : 1.5% of Vout (180mV) for worst case load transient
- Vin, ripple: 1.5% of Vin (420mVp-p)

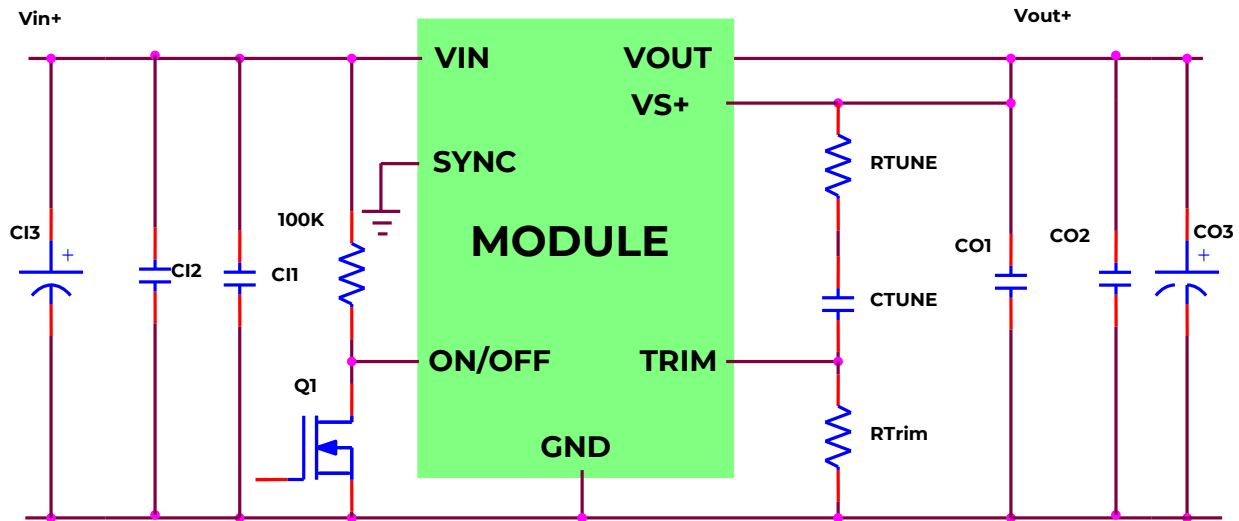

- C11 1 x 0.01 μ F/50V, 0603 ceramic capacitor
- C12 4 x 10 μ F/50V ceramic capacitor (e.g. Murata GRM32ER71H106K)
- C13 47 μ F/63V bulk electrolytic
- CO1 1 x 0.01 μ F/25V, 0306 ceramic capacitor (e.g. Murata LLL185R71E103MA01L))
- CO2 4 x 22 μ F/25V ceramic capacitor (e.g. Murata GCM32ER71E106KA42)
- CO3 NA
- CTune 470pF ceramic capacitor (can be 1206, 0805 or 0603 size)
- RTune 200 ohms SMT resistor (can be 1206, 0805 or 0603 size)
- RTrim 6.19k Ω resistor

APXW012 Mechanical Specifications

Mechanical Outline

Dimensions are in millimeters and (inches).

Tolerances: x.x mm ± 0.5 mm (x.xx in. ± 0.02 in.) [unless otherwise indicated]

x.xx mm ± 0.25 mm (x.xxx in ± 0.010 in.)

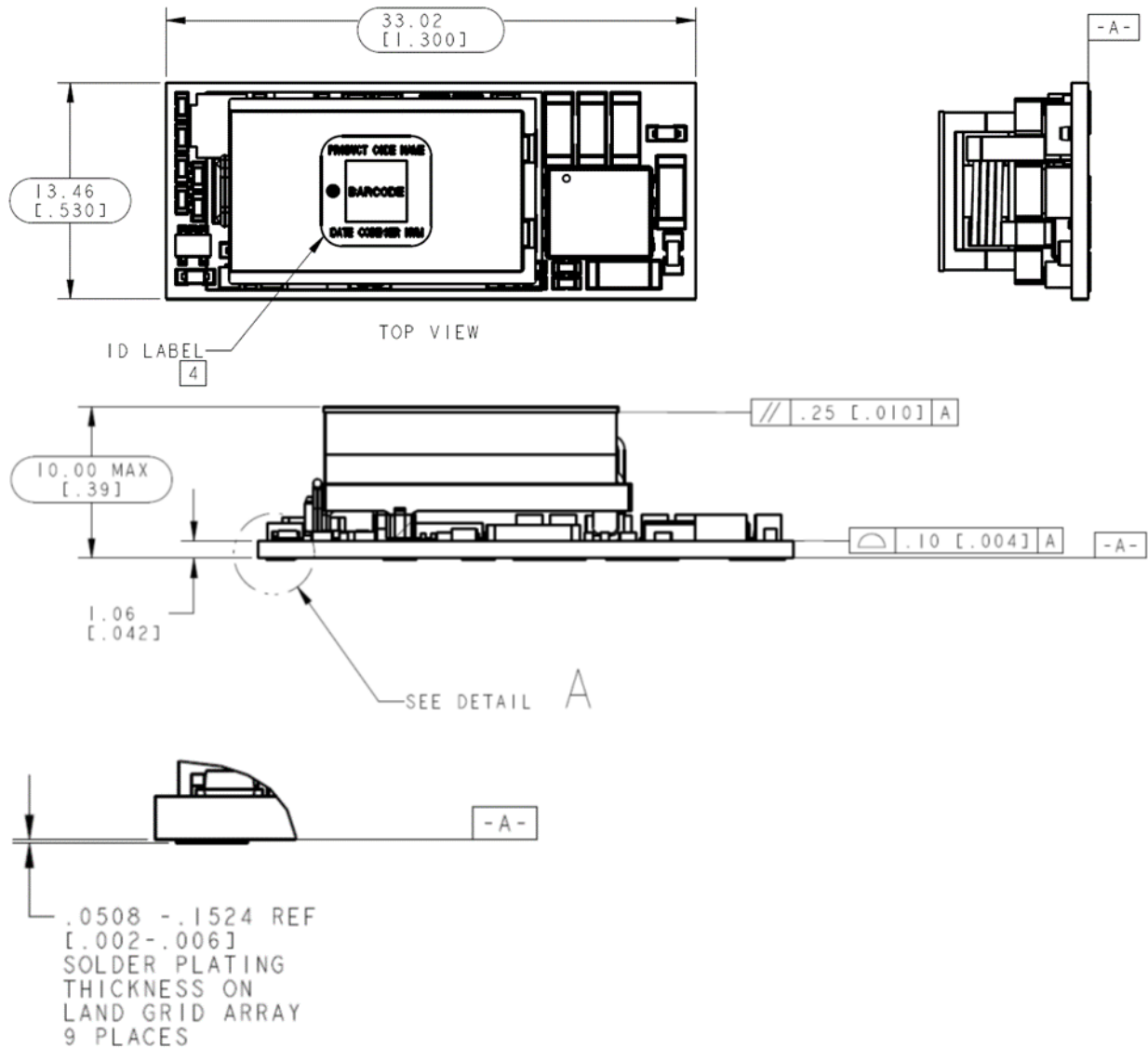

APXW012 Mechanical Specifications (continued)

Recommended Pad Layout

Dimensions are in millimeters and (inches).

Tolerances: x.x mm ± 0.5 mm (x.xx in. ± 0.02 in.) [unless otherwise indicated]

x.xx mm ± 0.25 mm (x.xxx in ± 0.010 in.)

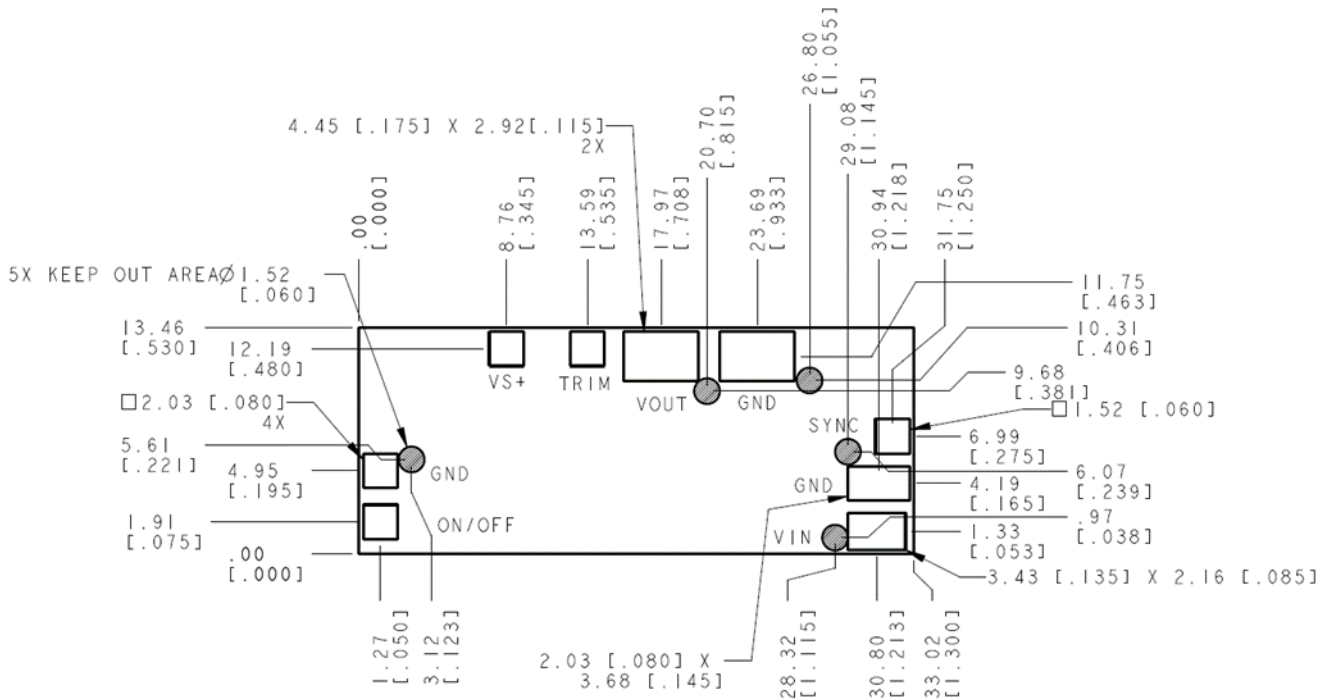

PIN	FUNCTION	PIN	FUNCTION
1	On/Off	6	V _{OUT}
2	V _{IN}	7	TRIM
3	GND	8	VS+
4	SYNC	9	GND
5	GND	10	

APXW012 Mechanical Specifications (continued)

Packaging Details

The 9-36V ProLynx modules are supplied in tape & reel as standard. Modules are shipped in quantities of 250 modules per reel.

All Dimensions are in millimeters and (in inches).

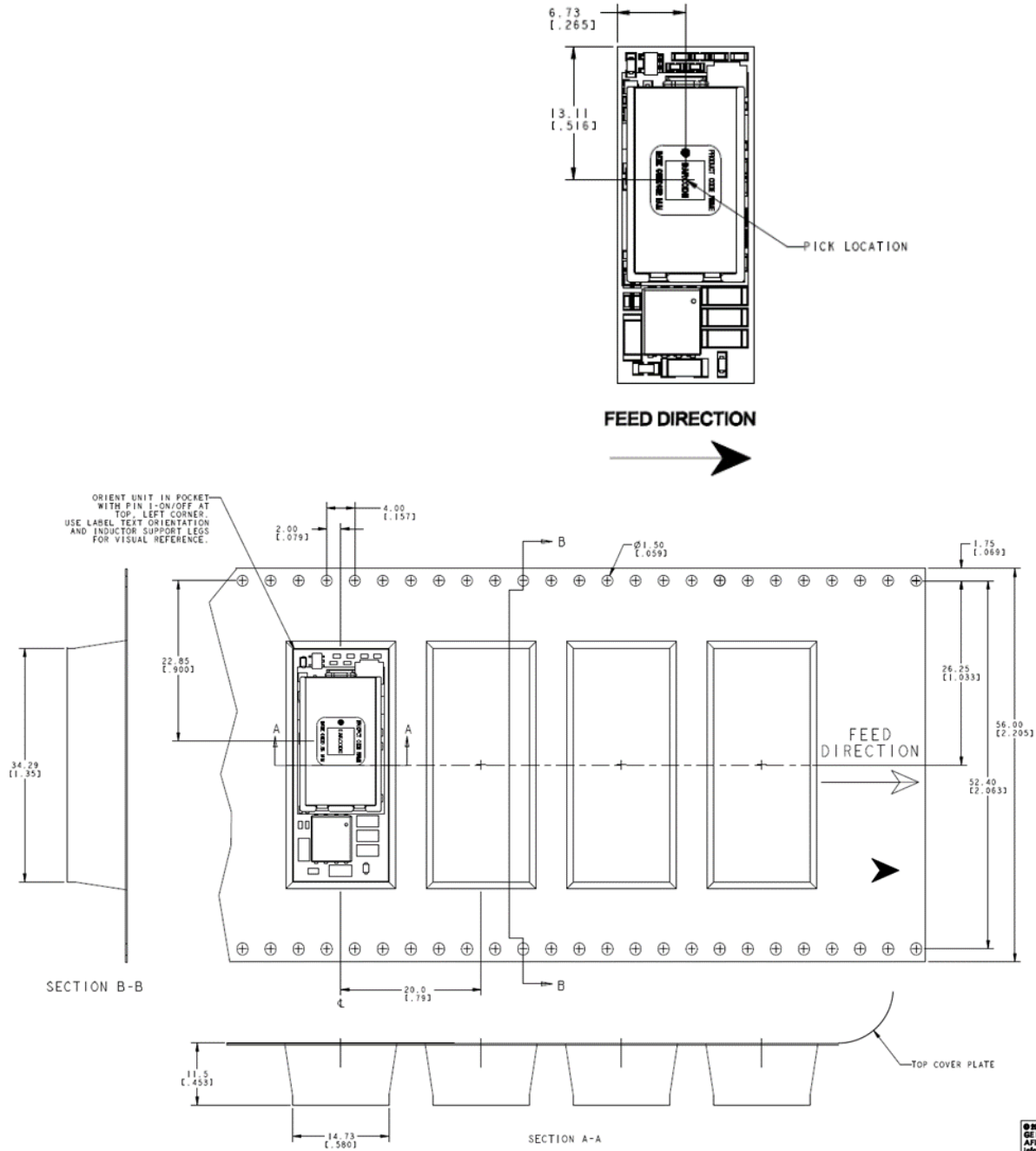

Reel Dimensions:

- Outside Dimensions: 330.2 mm (13.00")
- Inside Dimensions: 177.8 mm (7.00")
- Tape Width: 56.00 mm (2.205")

APXW012 Technical Specifications (continued)

Surface Mount Information

Pick and Place

The 9-36V ProLynx modules use an open frame construction and are designed for a fully automated assembly process. The modules are fitted with a label designed to provide a large surface area for pick and place operations. The label meets all the requirements for surface mount processing, as well as safety standards, and is able to withstand reflow temperatures of up to 300°C. The label also carries product information such as product code, serial number and the location of manufacture.

Nozzle Recommendations

The module weight has been kept to a minimum by using open frame construction. Variables such as nozzle size, tip style, vacuum pressure and placement speed should be considered to optimize this process. The minimum recommended inside nozzle diameter for reliable operation is 3mm. The maximum nozzle outer diameter, which will safely fit within the allowable component spacing, is 7 mm.

Bottom Side / First Side Assembly

This module is not recommended for assembly on the bottom side of a customer board. If such an assembly is attempted, components may fall off the module during the second reflow process.

Lead Free Soldering

The 9-36V ProLynx modules are lead-free (Pb-free) and RoHS compliant and fully compatible in a Pb-free soldering process. Failure to observe the instructions below may result in the failure of or cause damage to the modules and can adversely affect long-term reliability.

Pb-free Reflow Profile

Power Systems will comply with J-STD-020 Rev. D (Moisture/Reflow Sensitivity Classification for Nonhermetic Solid State Surface Mount Devices) for both Pb-free solder profiles and MSL classification procedures. This standard provides a recommended forced-air-convection reflow profile based on the volume and thickness of the package (table 4-2). The suggested Pb-free solder paste is Sn/Ag/Cu (SAC). The recommended linear reflow profile using Sn/Ag/Cu solder is shown in Figure 47. Soldering outside of the recommended profile requires testing to verify results and performance. For questions regarding

Land grid array(LGA) soldering, solder volume; please contact OmniOn Power™ for special manufacturing process instructions.

MSL Rating

The 9-36V ProLynx modules have a MSL rating of 2a.

Storage and Handling

The recommended storage environment and handling procedures for moisture-sensitive surface mount packages is detailed in J-STD-033 Rev. A (Handling, Packing, Shipping and Use of Moisture/Reflow Sensitive Surface Mount Devices). Moisture barrier bags (MBB) with desiccant are required for MSL ratings of 2 or greater. These sealed packages should not be broken until time of use. Once the original package is broken, the floor life of the product at conditions of ≤30°C and 60% relative humidity varies according to the MSL rating (see J-STD-033A). The shelf life for dry packed SMT packages will be a minimum of 12 months from the bag seal date, when stored at the following conditions: < 40° C, < 90% relative humidity.

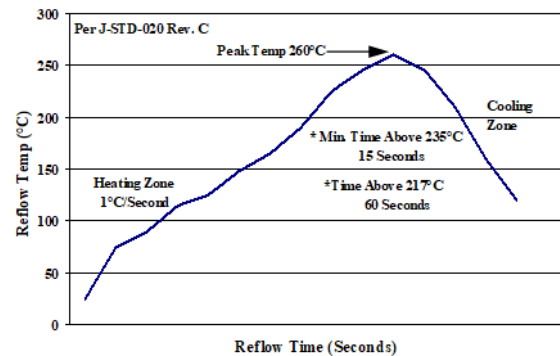

Figure 47. Recommended linear reflow profile using Sn/Ag/Cu solder.

Post Solder Cleaning and Drying Considerations

Post solder cleaning is usually the final circuit-board assembly process prior to electrical board testing. The result of inadequate cleaning and drying can affect both the reliability of a power module and the testability of the finished circuit-board assembly. For guidance on appropriate soldering, cleaning and drying procedures, refer to Board Mounted Power Modules: Soldering and Cleaning Application Note (AN04-001).

APXW012 Technical Specifications (continued)

EMC Considerations

The circuit below and plots in Figures 48 and 49 shows a suggested configuration to meet the radiated emission limits of EN55022 Class A. Actual performance depends on layout and external components used.

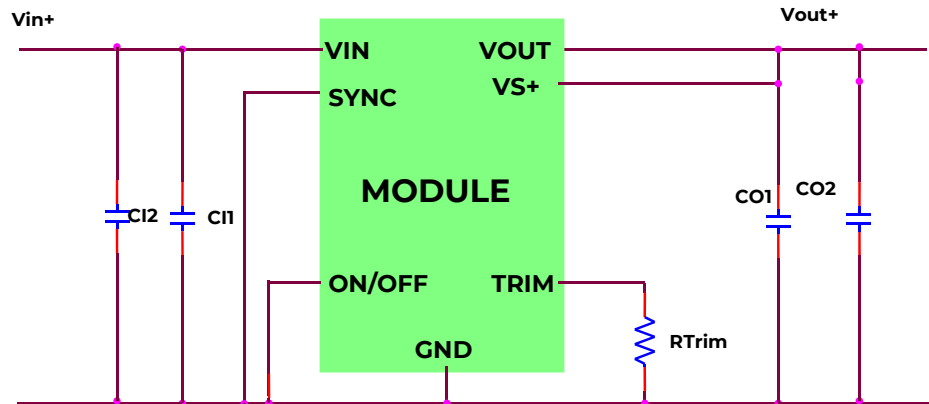

- C11 1 x 0.01mF/50V, 0603 ceramic capacitor
- C12 10uF/50V,
- CO1 1 x 0.01mF/25V, 0603 ceramic capacitor
- CO2 10uF/50V ceramic capacitor (e.g. Murata GCM32ER71E106KA42)
- RTrim 16.3kΩ resistor



Audix Technology (Shanghai) Co., Ltd.
 3F #34Bldg. No.680 GuiPing Rd.,CaoHeJing
 Hi-Tech Park,Shanghai 200233, China
 Tel:+86-21-64955500 Fax:+86-21-64955491
 audixaci@audix.com

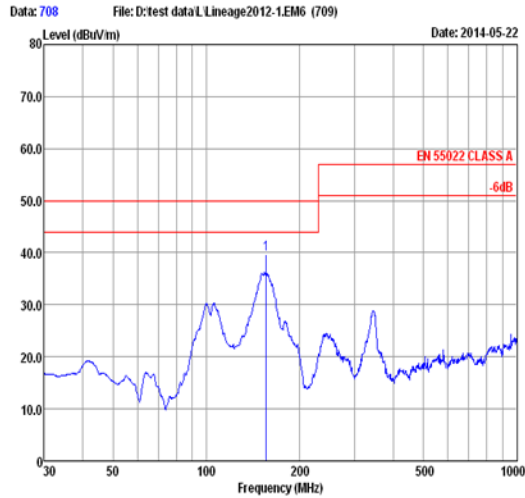

Site : site
 Condition : EN 55022 CLASS A HORIZONTAL
 Project No. :
 Applicant :
 EUT :
 M/N : APXW012
 S/N : SV 9A
 Power Supply : DC12V
 Ambient : 22°C 60%RH
 Test Mode : Full Load
 Test Engineer: Mark
 Memo :

Freq	Read		CableAntenna		Limit		Over
	Level	Loss Factor	Level	Line	Line	Remark	
MHz	dBuV	dB	dB/m	dBuV/m	dBuV/m	dB	
1	155.78	28.61	1.56	9.46	39.63	50.00	-10.37 QP



Audix Technology (Shanghai) Co., Ltd.
 3F #34Bldg. No.680 GuiPing Rd.,CaoHeJing
 Hi-Tech Park,Shanghai 200233, China
 Tel:+86-21-64955500 Fax:+86-21-64955491
 audixaci@audix.com

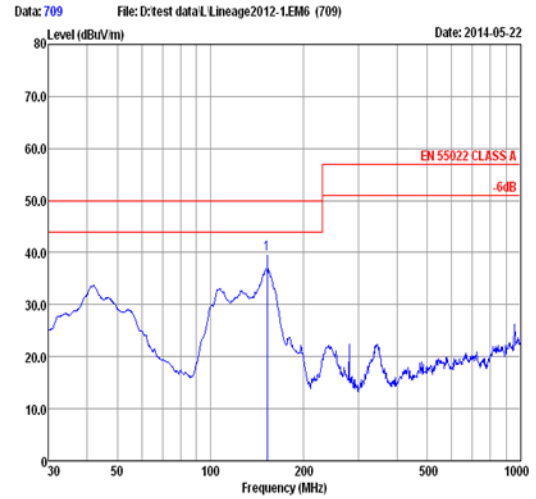

Site : Audix(Shanghai) Chamber3
 Condition : EN 55022 CLASS A VERTICAL
 Project No. :
 Applicant :
 EUT :
 M/N : APXW012
 S/N : SV 9A
 Power Supply : DC12V
 Ambient : 22°C 60%RH
 Test Mode : Full Load
 Test Engineer: Mark
 Memo :

Freq	Read		CableAntenna		Limit		Over
	Level	Loss Factor	Level	Line	Line	Remark	
MHz	dBuV	dB	dB/m	dBuV/m	dBuV/m	dB	
1	152.30	28.00	1.53	10.05	39.58	50.00	-10.42 QP

Figure 48. EMI Plot of APXW012 on evaluation board with 12V in/ 5Vo @ 9A out

APXW012 Technical Specifications (continued)



Audix Technology (Shanghai) Co., Ltd.
 3F #34Bldg. No.680 GuiPing Rd.,CaoHeJing
 Hi-Tech Park,Shanghai 200233, China
 Tel:+86-21-64955500 Fax:+86-21-64955491
 audixaci@audix.com



Audix Technology (Shanghai) Co., Ltd.
 3F #34Bldg. No.680 GuiPing Rd.,CaoHeJing
 Hi-Tech Park,Shanghai 200233, China
 Tel:+86-21-64955500 Fax:+86-21-64955491
 audixaci@audix.com

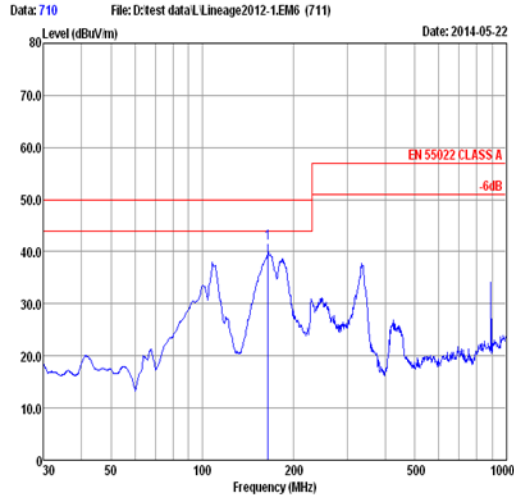

Site : Audix(Shanghai) Chamber3
 Condition : EN 55022 CLASS A HORIZONTAL
 Project No. :
 Applicant :
 EUT :
 M/N : APXW012
 S/N : SV 9A
 Power Supply : DC 28V
 Ambient : 22°C 60%RH
 Test Mode : Full Load
 Test Engineer: Mark
 Memo :

	Read Freq	CableAntenna Level	Loss Factor	Level	Limit	Over	Remark
	MHz	dBuV	dB	dB/m	dBuV/m	dB	
1	164.18	30.69	1.61	9.29	41.59	50.00	-8.41 QP

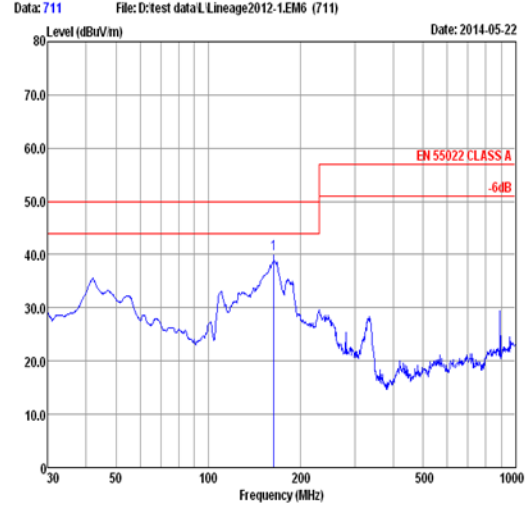

Site : Audix(Shanghai) Chamber3
 Condition : EN 55022 CLASS A VERTICAL
 Project No. :
 Applicant :
 EUT :
 M/N : APXW012
 S/N : SV 9A
 Power Supply : DC 28V
 Ambient : 22°C 60%RH
 Test Mode : Full Load
 Test Engineer: Mark
 Memo :

	Read Freq	CableAntenna Level	Loss Factor	Level	Limit	Over	Remark
	MHz	dBuV	dB	dB/m	dBuV/m	dB	
1	163.54	29.29	1.61	9.28	40.18	50.00	-9.82 QP

Figure 49. EMI Plot of APXW012 on evaluation board with 28 V in/ 5Vdc @ 9A out

APXW012 Ordering Information

Please contact your OmniOn Power™ Sales Representative for pricing, availability and optional features.

Table 8. Device Codes

Device Code	Input Voltage Range	Output Voltage	Output Current	On/Off Logic	Connector Type	Ordering Code
APXW012A0X3-SRZ (NRND, LTB 5/1/2025)	9 – 36Vdc	3 – 18Vdc	12A – 6A	Negative	SMT	150028492
APXW012A0X3-SRDZ (NRND, LTB 5/1/2025)				Negative		150034987
APXW012A0X43-SRZ (NRND, LTB 5/1/2025)				Positive		150035002
APXW012A0X3-78SRZ ¹				Negative		1600487077A
APXW012A0X3-78SRDZ ¹				Negative		1600487079A
APXW012A0X43-78SRZ ¹				Positive		1600487081A

-Z refers to RoHS compliant parts

¹-78 variants have slightly narrower supported input voltage / output voltage combinations. Search datasheet with “-78” to review differences.

Table 9. Coding Scheme

TLynx family	Sequencing feature	Input voltage range	Output current	Output voltage	On/Off logic	Remote Sense	Options	Options	RoHS Compliance	
AP	X	W	012	X	4	3	-78	-SR	-D	Z
	X = w/o Seq	W = 9-36V	12A	X = programmable output	4 = positive No entry = negative	Available		S = Surface Mount R = Tape & Reel	D = 105°C operating ambient, 40G operating shock as per MIL Std 810G	Z = RoHS

Change History (excludes grammar & clarifications)

Revision	Date	Description of the change
1.14	06/23/2022	Updated typos in cap designation
1.15	11/20/2023	Updated as per OmniOn Power™ template
1.16	05/29/2024	Trademark ™ removed from ProLynx
1.17	02/25/2025	Added Figures - 14, 22, 31, 34, 40 Added -78 version in Ordering Information
1.18	03/07/2025	Marked non-78 versions are NRND. EOL notice has been sent out. Customers are requested to use -78 versions.
1.19	03/27/2025	Add verbiage to title page that includes -78SRZ Models
1.20	05/02/2025	Numeric representation table added after figure 40

OmniOn Power Inc.

601 Shiloh Rd.
Plano, TX USA

omnionpower.com

We reserve the right to make technical changes or modify the contents of this document without prior notice. OmniOn Power™ does not accept any responsibility for errors or lack of information in this document and makes no warranty with respect to and assumes no liability as a result of any use of information in this document.

We reserve all rights in this document and in the subject matter and illustrations contained therein. Any reproduction, disclosure to third parties or utilization of its contents – in whole or in parts – is forbidden without prior written consent of OmniOn Power™. This document does not convey license to any patent or any intellectual property right. Copyright© 2025 OmniOn Power Inc. All rights reserved.