

DATASHEET

130W Boost Converter: Non-Isolated DC-DC Power Modules

8V_{dc} –16V_{dc} input; 32V_{dc} – 54V_{dc} output, 130W output power (max.)

RoHS Compliant

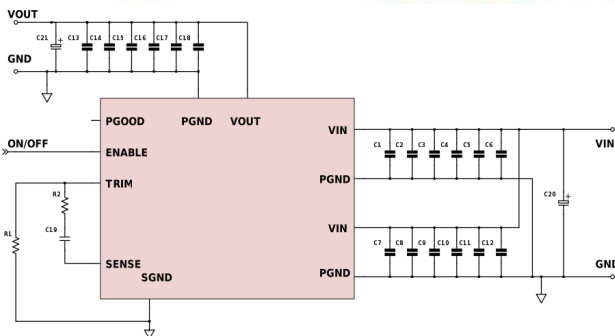

Description

The Boost power modules are non-isolated dc-dc converters that can deliver up to 130W of output power. The module can operate over a wide range of input voltage ($V_{IN} = 8V_{dc}-16V_{dc}$) and provide an adjustable 32 to 54V_{DC} output. The output voltage is programmable via an external resistor. Features include remote On/Off, over current and over temperature protection. The module also includes the Tunable Loop™ feature that allows the user to optimize the dynamic response of the converter to match the load with reduced amount of output capacitance leading to savings on cost and PWB area.

Applications

- Industrial equipment
- Distributed power architectures
- Telecommunications equipment

Features

- Compliant to RoHS Directive 2011/65/EU and amended Directive (EU) 2015/863
- Compliant to IPC-9592 (September 2008), Category 2, Class II
- Compatible in a Pb-free or SnPb reflow environment (Z versions)
- Compliant to REACH Directive (EC) No 1907/2006
- Wide Input voltage range (8V_{dc}-16V_{dc})
- Output voltage programmable from 32 to 54V_{dc} via external resistor
- Tunable Loop™ to optimize dynamic output voltage response
- Power Good signal
- Output over current protection (V_o drops to V_{in})
- Over temperature protection
- Remote On/Off
- Support Pre-Biased Output
- Optimized for conduction-cooled applications
- Small size: 27.9 mm x 24 mm x 8.5 mm (MAX)
- Wide operating temperature range [-40°C to 85°C]
- ANSI/UL* 62368-1 and CAN/ CSA† C22.2 No. 62368-1 Recognized, DIN VDE‡ 0868-1/A11:2017 (EN62368- 1:2014/A11:2017)
- ISO** 9001 and ISO 14001 certified manufacturing facilities

See footnotes on page no. :- 3

Page 1

Technical Specifications

Absolute Maximum Ratings

Stresses in excess of the absolute maximum ratings can cause permanent damage to the device. These are absolute stress ratings only, functional operation of the device is not implied at these or any other conditions in excess of those given in the operations sections of the data sheet. Exposure to absolute maximum ratings for extended periods can adversely affect the device reliability.

| Parameter | Device | Symbol | Min | Max | Unit |
|---|--------|-----------|------|-----|------|
| Input Voltage Continuous | All | V_{IN} | -0.3 | 18 | V |
| Operating Ambient Temperature (see Thermal Considerations section) | All | T_A | -40 | 85 | °C |
| Storage Temperature | All | T_{stg} | -55 | 125 | °C |

General Specifications

| Parameter | Device | Min | Typ | Max | Unit |
|--|--------|-----|------------|-----|---------|
| Calculated MTBF ($I_O=0.8I_{O,max}$, $T_A=40^\circ\text{C}$) Telecordia Issue 3 Method 1 Case 3 | All | | 32,263,860 | | Hours |
| Weight | | — | 10.8 | — | g (oz.) |

Electrical Specifications

Unless otherwise indicated, specifications apply over all operating input voltage, resistive load, and temperature conditions.

| Parameter | Device | Symbol | Min | Typ | Max | Unit |
|---|------------------------------|-------------------|-----|-----------|-----|----------------|
| Operating Input Voltage | All | V_{IN} | 8 | — | 16 | V_{dc} |
| Maximum Input Current (Note 1) ($V_{IN}=8\text{V}$, $V_{out} = 34\text{V}$, $I_O=I_{O,max}$) | All | I_{IN1max} | | | 20 | A_{dc} |
| Input No Load Current ($V_{IN} = 12V_{dc}$, $I_O = 0$, module enabled) | $V_{O,set} = 40$ V_{dc} | $I_{IN,No\ load}$ | | | 300 | mA |
| | $V_{O,set} = 54V_{dc}$ | $I_{IN,No\ load}$ | | | 350 | mA |
| Input Stand-by Current ($V_{IN} = 12V_{dc}$, module disabled) | All | $I_{IN,stand-by}$ | | 10 | 20 | mA |
| Inrush Transient | All | I_1^2t | | | 1 | A^2s |
| Input Reflected Ripple Current, peak-to-peak (5Hz to 20MHz, $1\mu\text{H}$ source impedance; $V_{IN} = 8$ to 16V, $I_O=I_{O,max}$; See Test Configurations) | All | | | 285 | | mAp-p |
| Input Ripple Rejection (120Hz) | All | | | 15 | | dB |
| Output Voltage Set-point (with 0.1% tolerance for external resistor used to set output voltage) | All | $V_{o,set}$ | | $\pm 1\%$ | | $\% V_{o,set}$ |
| Output Voltage (Overall operating input voltage, resistive load, and temperature conditions until end of life) | All | $V_{o,set}$ | | $\pm 3\%$ | | $\% V_{o,set}$ |
| Adjustment Range (selected by an external resistor) | All | V_o | 32 | | 54 | V_{dc} |
| Remote Sense Range | All | | | | 0.5 | V_{dc} |
| Output Voltage during module "off" state ³ | All | V_o | | V_{in} | | V_{dc} |

Note 1 – Both pairs of input power pins (3, 4, 5, and 6) must be used

See footnotes on page no. :- 3

Technical Specifications (continued)

Electrical Specifications (continued)

| Parameter | Device | Symbol | Min | Typ | Max | Unit |
|---|--------------------|-------------|-----|------------|------|---------------|
| Output Regulation | | | | | | |
| Line ($V_{IN}=V_{IN,min}$ to $V_{IN,max}$) | All | | | 0.4 | | % $V_{O,set}$ |
| Load ($I_O=I_{O,min}$ to $I_{O,max}$) | All | | | 0.4 | | % $V_{O,set}$ |
| Temperature ($T_{ref}=T_{A,min}$ to $T_{A,max}$) | All | | | 0.4 | | % $V_{O,set}$ |
| Input Noise on nominal input at 25°C ($V_{IN}=V_{IN,nom}$ and $I_O=I_{O,min}$ to $I_{O,max}$ $C_{in}=470\mu F$) Peak-to-Peak (Full Bandwidth) for all V_O | All | | — | 3% | | mVpk-pk |
| Output Ripple and Noise on nominal output at 25°C ($V_{IN}=V_{IN,nom}$ and $I_O=I_{O,min}$ to $I_{O,max}$ $C_o=2*470\mu F$) Peak-to-Peak (Full bandwidth) RMS (Full bandwidth) | All | | | 300 180 | | mVpk-pk mV |
| External Capacitance ¹ Without the Tunable Loop™ ESR $\geq 1\text{ m}\Omega$ | All | $C_{O,max}$ | 22 | | 122 | μF |
| With the Tunable Loop™ ESR $\geq 0.15\text{ m}\Omega$ | All | $C_{O,max}$ | 47 | | 1000 | μF |
| ESR $\geq 10\text{ m}\Omega$ | All | $C_{O,max}$ | | | 1000 | μF |
| Output power | All | P_o | 0 | | 130 | Watts |
| Output Current | $32V_{out}$ | I_o | | | 4.06 | A |
| | $40V_{out}$ | | | | 3.25 | |
| | $48V_{out}$ | | | | 2.71 | |
| | $54V_{out}$ | | | | 2.41 | |
| Output Current Limit Inception (Hiccup Mode) (current limit does not operate in sink mode) 2 | All | $I_{o,lim}$ | | 150 | | % $I_{o,max}$ |
| Efficiency | $V_{O_r}=40V_{dc}$ | η | | 93.0 | | % |
| $V_{IN}=12V_{dc}$, $T_A=25^\circ C$ | $V_{O_r}=48V_{dc}$ | η | | 92.0 | | % |
| $I_O=I_{O,max}$, $V_O=V_{O,set}$ | $V_{O_r}=54V_{dc}$ | η | | 91.0 | | % |
| Switching Frequency | All | f_{sw} | — | 322 | — | kHz |

- External capacitors may require using the new Tunable Loop™ feature to ensure that the module is stable as well as getting the best transient response. See the Tunable Loop™ section for details.
- Because of the inherent body diode of the high-side MOSFET in Synchronous Boost Converter, this Boost PoL do not support short circuit protection. When OCP, V_{OUT} will be drop down to a voltage close to V_{in} (Not 0V), so the total output power will be reduced.
- Please note because of the specific design of the BOOST topology, the input voltage will present on the output when the input voltage is applied. This will occur even when the unit is in its "OFF" State. When the module is turned ON, the output voltage will start to rise from V_{in} level and not 0V. When turning off, the output will only drop back to V_{in} (If V_{in} is still present). Please refer to Figure 23 for typical start-up waveform using Remote ON/OFF. It shows the V_{in} level present prior to turning the module "ON"

Footnotes

- * UL is a registered trademark of Underwriters Laboratories, Inc.
- † CSA is a registered trademark of Canadian Standards Association.
- ‡ VDE is a trademark of Verband Deutscher Elektrotechniker e.V.
- ** ISO is a registered trademark of the International Organization of Standards

Technical Specifications (continued)

Feature Specifications

| Parameter | Device | Symbol | Min | Typ | Max | Unit |
|---|--------|--------------|------|-------|--------------|----------------|
| On/Off Signal Interface ($V_{IN}=V_{IN,min}$ to $V_{IN,max}$; open collector or equivalent, Signal referenced to GND) | | | | | | |
| Device Code with no suffix – Negative Logic (See Ordering Information) (On/OFF pin is open collector/drain logic input with external pull-up resistor; signal referenced to GND) | | | | | | |
| Logic High (Module OFF) | | | | | | |
| Input High Current | All | I_{IH} | — | — | 1 | mA |
| Input High Voltage | All | V_{IH} | 2.5 | — | $V_{IN,max}$ | V_{dc} |
| Logic Low (Module ON) | | | | | | |
| Input low Current | All | I_{IL} | — | — | 1 | mA |
| Input Low Voltage | All | V_{IL} | -0.2 | — | 0.6 | V_{dc} |
| Turn-On Delay and Rise Times | | | | | | |
| ($V_{IN}=V_{IN,nom}$, $I_O=I_{O,max}$, V_O to within $\pm 1\%$ of steady state) | | | | | | |
| Case 1: On/Off input is enabled and then input power is applied (delay from instant at which $V_{IN} = V_{IN,min}$ until $V_O = 10\%$ of $(V_{O,set} - V_{in})$) | All | T_{delay1} | — | 24 | — | msec |
| Case 2: Input power is applied for at least one second and then the On/Off input is enabled (delay from instant at which $V_{on/off}$ is enabled until $V_O = 10\%$ of $(V_{O,set} - V_{in})$) | All | T_{delay1} | — | 24 | — | msec |
| Output voltage Rise time (time for V_O to rise from 10% of $(V_{O,set} - V_{in})$, set to 90% of $(V_{O,set} - V_{in})$) | All | T_{rise1} | | 32 | — | msec |
| Output voltage overshoot ($T_A = 25^\circ C$, $V_{IN} = V_{IN,min}$ to $V_{IN,max}$, $I_O = I_{O,min}$ to $I_{O,max}$) With or without maximum external capacitance | | | | 3 | | $\% V_{O,set}$ |
| Over Temperature Protection (See Thermal Considerations section) | All | T_{ref} | | 135 | | $^\circ C$ |
| Input Undervoltage Lockout * | | | | | | |
| Turn-on Threshold | All | | | | 7.7 | V_{dc} |
| Turn-off Threshold | All | | 6.0 | | | V_{dc} |
| Hysteresis | All | | | 1 | | V_{dc} |
| PGOOD (Power Good) | | | | | | |
| Signal Interface Open Drain, $V_{supply} \leq 5V_{DC}$ | | | | | | |
| Overshoot threshold for PGOOD ON | All | | | 107.6 | | $\% V_{O,set}$ |
| Overshoot threshold for PGOOD OFF | All | | | 112.8 | | $\% V_{O,set}$ |
| Undervoltage threshold for PGOOD ON | All | | | 92.2 | | $\% V_{O,set}$ |
| Undervoltage threshold for PGOOD OFF | All | | | 87.9 | | $\% V_{O,set}$ |
| Pulldown resistance of PGOOD pin | All | | | 94 | | Ω |
| Sink current capability into PGOOD pin | All | | 6 | | | mA |

* For $V_{out} > 32V$, there is a minimum V_{in} at different V_{out} , Input UVLO doesn't apply

Technical Specifications (continued)

Characteristic Curves $V_o = 32V$

The following figures provide typical characteristics for the ABXS003at 32V_o and 25°C.

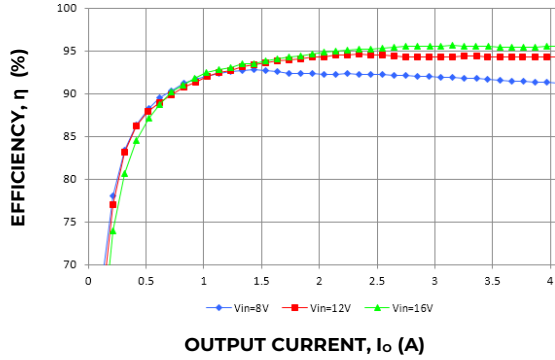

Figure 1. Converter Efficiency versus Output Current.

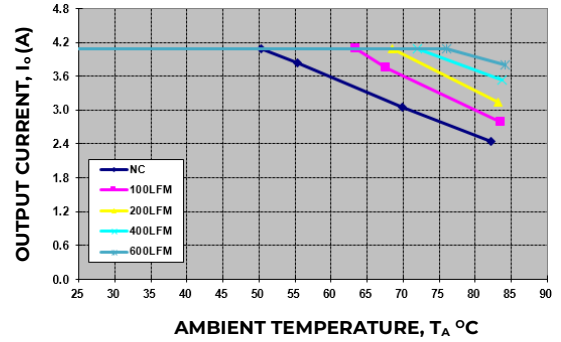

Figure 2. Derating Output Current versus Ambient Temperature and Airflow. $V_{IN}=12V$

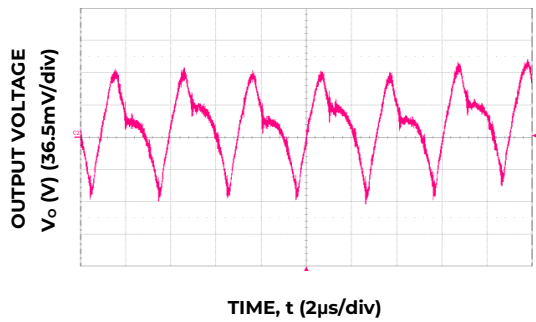

Figure 3. Typical output ripple and noise ($C_o=3x10uF+470uF$, $V_{IN} = 12V$, $I_o = I_{o,max}$).

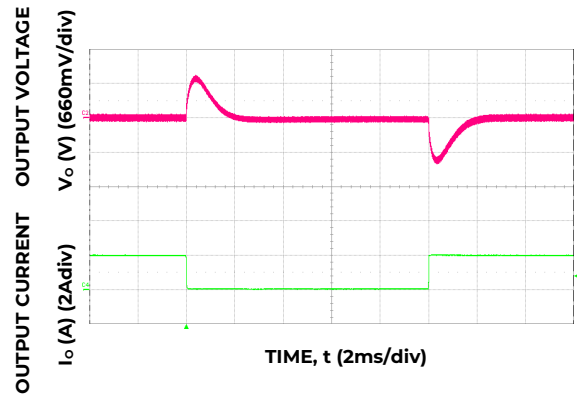

Figure 4. Transient Response to Dynamic Load Change from 50% to 0% at 12V_{in}, $C_{out}=3x10uF+470uF$, $C_{Tune}=1000pF$, $R_{Tune}=30.1k\Omega$

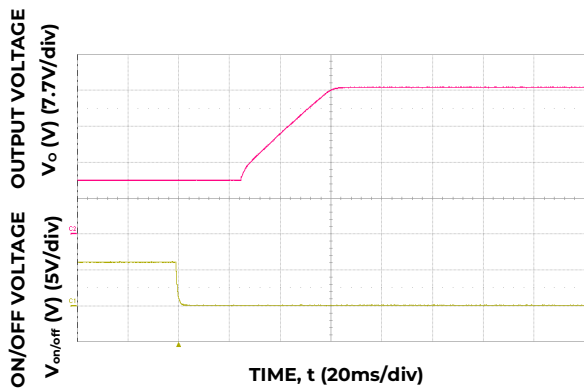

Figure 5. Typical Start-up Using On/Off Voltage ($I_o = I_{o,max}$).

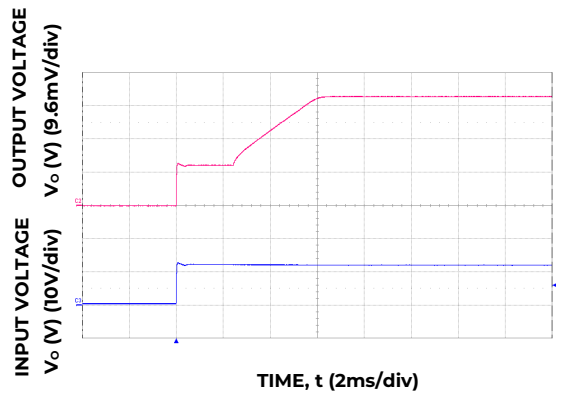

Figure 6. Typical Start-up Using Input Voltage ($V_{IN} = 12V$, $I_o = I_{o,max}$).

Technical Specifications (continued)

Characteristic Curves $V_o = 40V$

The following figures provide typical characteristics for the ABXS003 at 40V_o and 25°C.

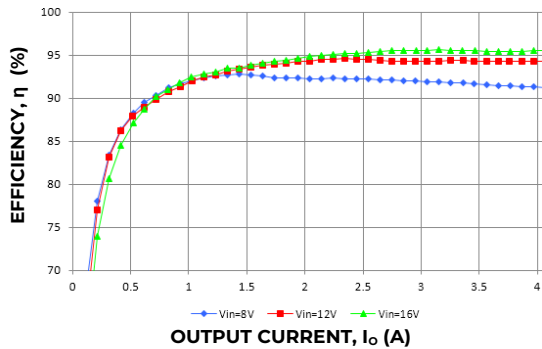

Figure 7. Converter Efficiency versus Output Current.

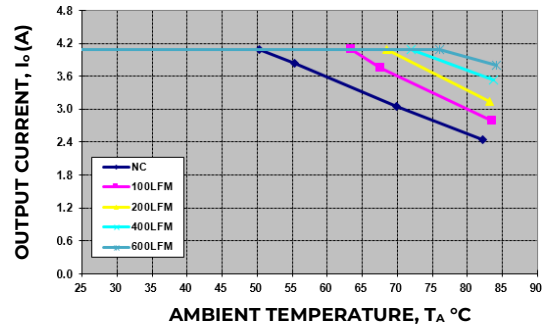

Figure 8. Derating Output Current versus Ambient Temperature and Airflow., $V_{IN}=12V$

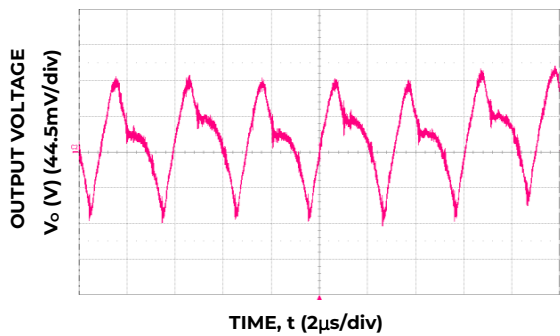

Figure 9. Typical output ripple and noise ($C_o=3x10uF+470uF$, $V_{IN} = 12V$, $I_o = I_{o,max}$).

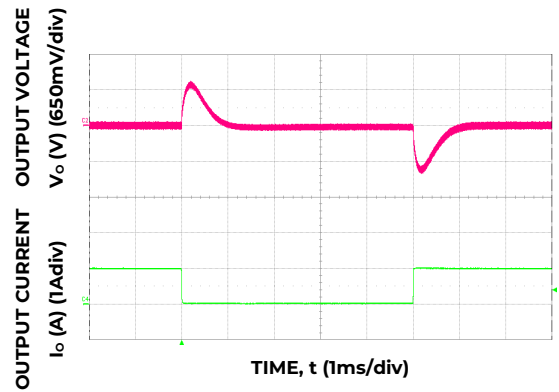

Figure 10. Transient Response to Dynamic Load Change from 50% to 0% at 12V_{in}, $C_{out}=3x10uF+470uF$, $C_{Tune}=1000pF$, $R_{Tune}=30.1k\Omega$

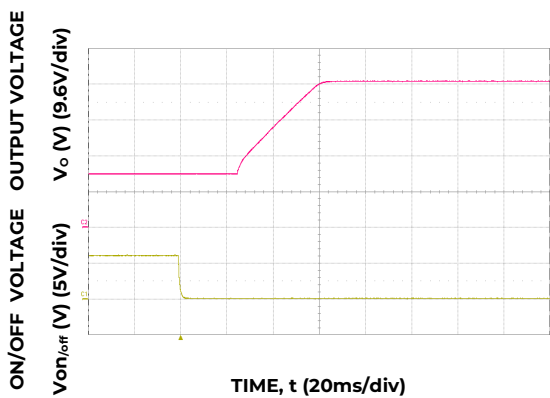

Figure 11. Typical Start-up Using On/Off Voltage ($I_o = I_{o,max}$).

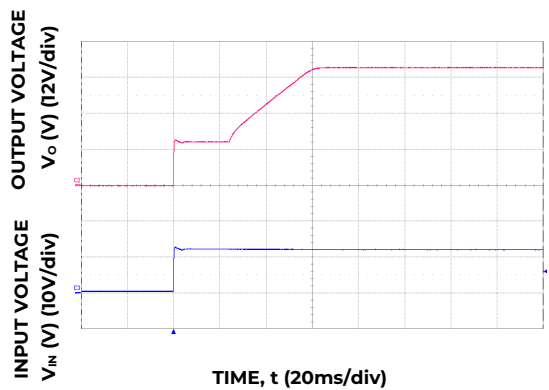

Figure 12. Typical Start-up Using Input Voltage ($V_{IN} = 12V$, $I_o = I_{o,max}$).

Technical Specifications (continued)

Characteristic Curves $V_o = 48V$

The following figures provide typical characteristics for the ABXS003 at 48V_o and 25°C.

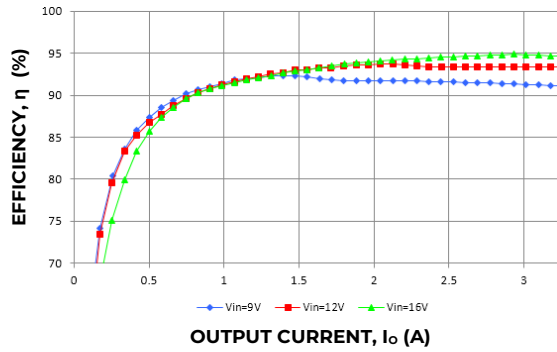

Figure 13. Converter Efficiency versus Output Current.

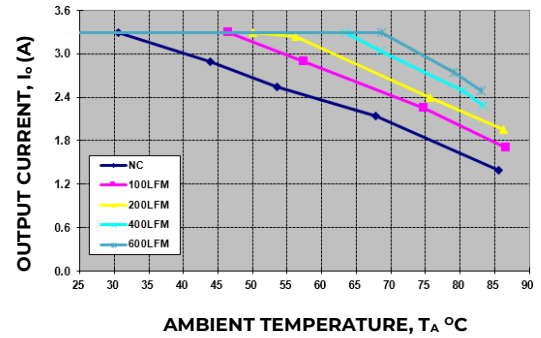

Figure 14. Derating Output Current versus Ambient Temperature and Airflow. $V_{IN}=12V$

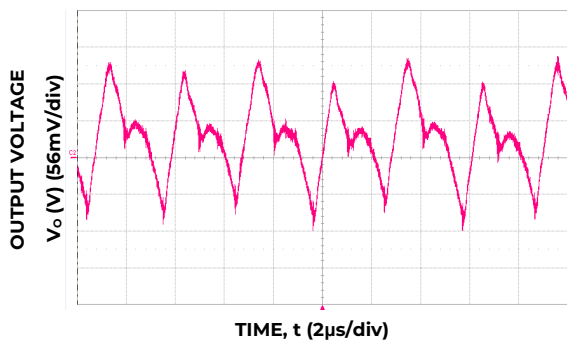

Figure 15. Typical output ripple and noise ($C_o=3 \times 10 \mu F + 470 \mu F$, $V_{IN} = 12V$, $I_o = I_{o,max}$).

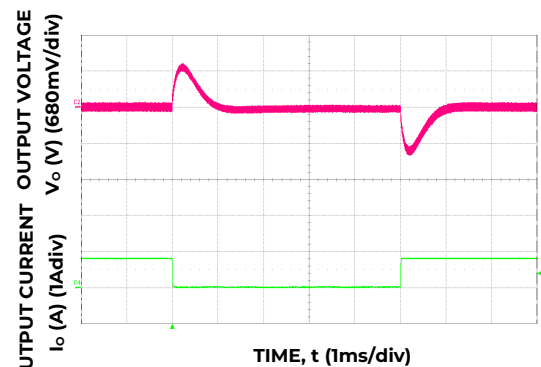

Figure 16. Transient Response to Dynamic Load Change from 50% to 0% at $12V_{in}$, $C_{out}=470 \mu F$, $C_{Tune}=1000pF$, $R_{Tune}=30.1k\Omega$

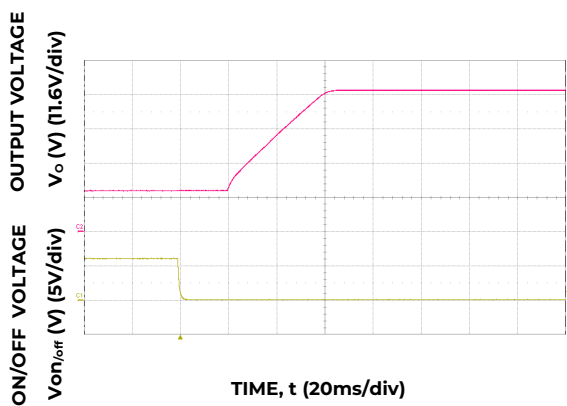

Figure 17. Typical Start-up Using On/Off Voltage ($I_o = I_{o,max}$).

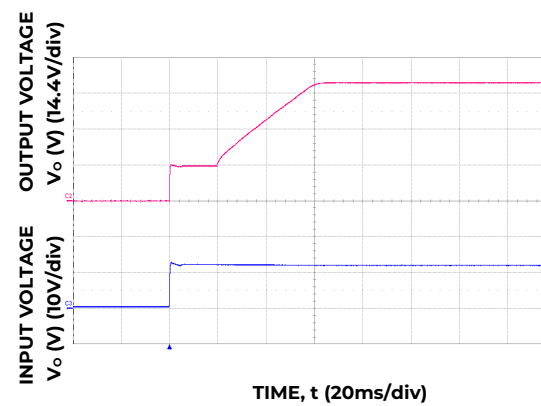

Figure 18. Typical Start-up Using Input Voltage ($V_{IN} = 12V$, $I_o = I_{o,max}$).

Technical Specifications (continued)

Characteristic Curves $V_o = 54V$

The following figures provide typical characteristics for the ABXS003 at 54V_o and 25°C

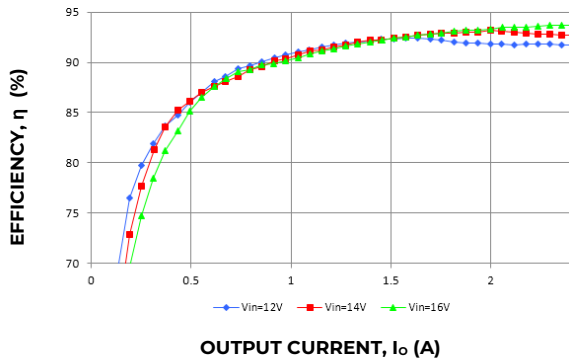

Figure 19. Converter Efficiency versus Output Current.

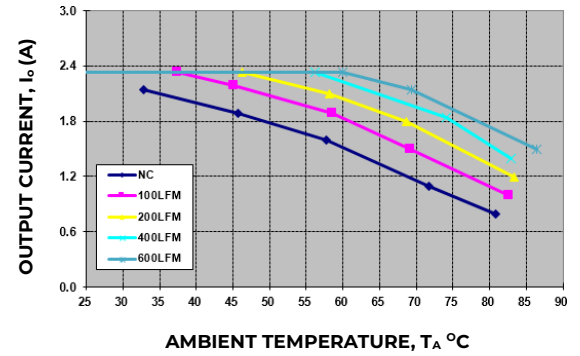

Figure 20. Derating Output Current versus Ambient Temperature and Airflow. $V_{IN} = 14V$

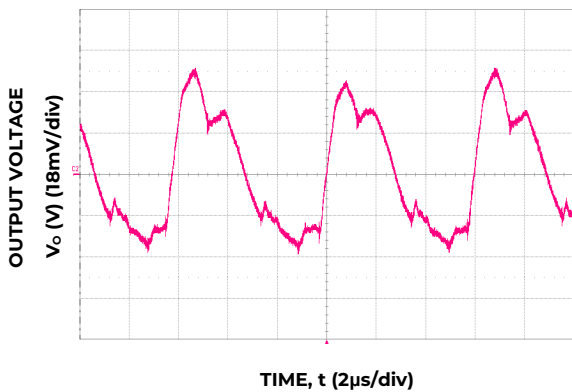

Figure 21. Typical output ripple and noise ($C_o=3x10uF+470uF$, $V_{IN} = 12V$, $I_o = I_{o,max}$).

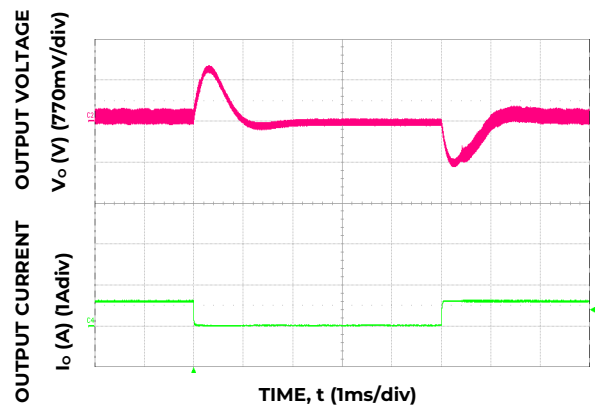

Figure 22. Transient Response to Dynamic Load Change from 50% to 0% at 12V_{in}, $C_{out}=470uF$, $C_{Tune}=1000pF$, $R_{Tune}=30.1k\Omega$

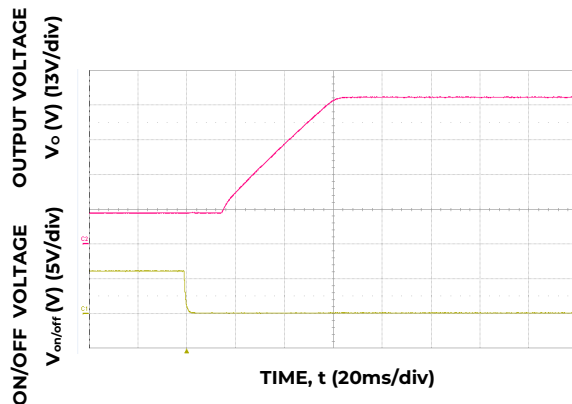

Figure 23. Typical Start-up Using On/Off Voltage ($I_o = I_{o,max}$).

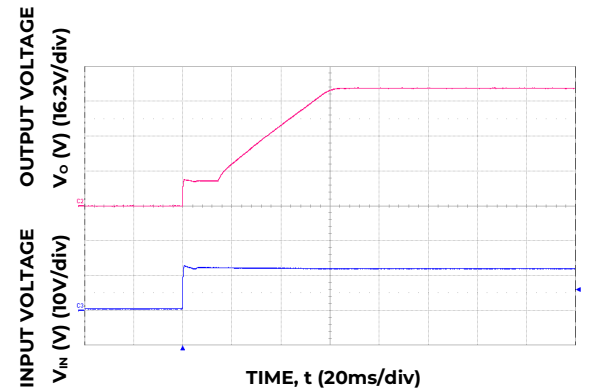

Figure 24. Typical Start-up Using Input Voltage ($V_{IN} = 12V$, $I_o = I_{o,max}$).

Technical Specifications (continued)

Input Filtering

The ABXS003 Open Frame module should be connected to a low ac-impedance source. A highly inductive source can affect the stability of the module. An input capacitance must be placed directly adjacent to the input pin of the module, to minimize input ripple voltage and ensure module stability.

To minimize input voltage ripple, ceramic capacitors are recommended at the input of the module.

Both pairs of input power pins (3, 4, 5, and 6) must be used.

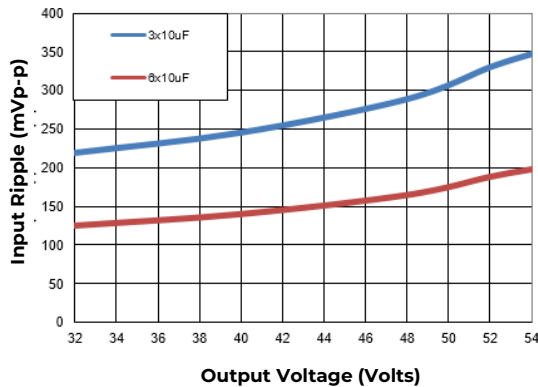

Figure 25. Input ripple voltage. Input voltage is 12V. Scope BW Limited to 20MHz

Output Filtering

These modules are designed for low output ripple voltage and will meet the maximum output ripple specification with 66uF ceramic capacitors at the output of the module. However, additional output filtering may be required by the system designer for a number of reasons. First, there may be a need to further reduce the output ripple and noise of the module. Second, the dynamic response characteristics may need to be customized to a particular load step change.

To reduce the output ripple and improve the dynamic response to a step load change, additional capacitance at the output can be used. Low ESR polymer and ceramic capacitors are recommended to improve the dynamic response of the module. Figure 26 provides output ripple information, measured with a scope with its Bandwidth limited to 20MHz for different external capacitance values at various Vo. For stable operation of the module, limit the capacitance to less than the maximum output

capacitance as specified in the electrical specification table. Optimal performance of the module can be achieved by using the Tunable Loop™ feature described later in this data sheet.

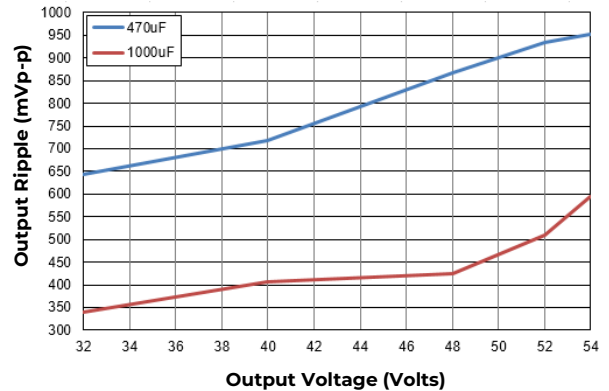

Figure 26. Output ripple voltage. Input voltage is 12V. Scope BW Limited to 20MHz

Safety Considerations

For safety agency approval the power module must be installed in compliance with the spacing and separation requirements of the end-use safety agency standards, i.e., UL ANSI/UL 62368-1 and CAN/CSA C22.2 No. 62368-1 Recognized, DIN VDE 0868-1/A11:2017 (EN62368-1:2014/A11:2017).

For the converter output to be considered meeting the Requirements of safety extra-low voltage (SELV) or ES1, the input must meet SELV/ES1 requirements. The power module has extra-low voltage (ELV) outputs when all inputs are ELV.

The input to these units is to be provided with a 25A Fuse in the positive input lead.

Technical Specifications (continued)

Analog Feature Descriptions

Remote On/Off

The ABXS003 Open Frame power modules feature an On/Off pin for remote On/Off operation.

For negative logic On/Off modules, the circuit configuration is shown in Fig. 27. The On/Off pin should be pulled high with an external pull-up resistor. When Q1 turns On, the On/Off pin is pulled low. This turns Q2 off and the internal PWM Enable is pulled high and the module turns on. When Q1 is Off, Q2 turns ON and the internal PWM Enable is pulled low and the module turns OFF

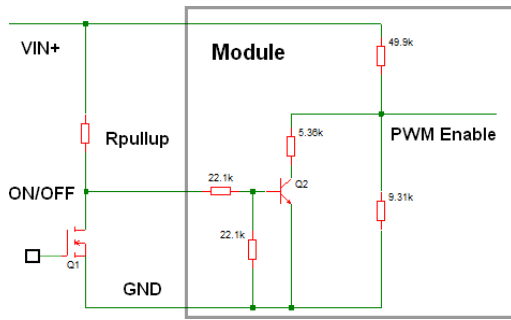

Figure 27. Circuit configuration for using negative On/Off logic.

Please note because of the specific design of the BOOST topology, the input voltage will present on the output when the input voltage is applied. This will occur even when the unit is in its "OFF" State.

When the module is turned ON, the output voltage will start to rise from Vin level and not 0V. When turning off, the output will only drop back to Vin (If Vin is still present). Please refer to Figure 23 for typical start-up waveform using Remote ON/OFF. it shows the Vin level present prior to turning the module "ON"

Monotonic Start-up and Shutdown

The module has monotonic start-up and shutdown behavior for any combination of rated input voltage, output current and operating temperature range.

Startup into Pre-biased Output

The module can start into a prebiased output as long as the prebias voltage is 5V less than the set output voltage.

Analog Output Voltage Programming

The output voltage of each output of the module can be programmable to any voltage from 16VDC to 34VDC by connecting a resistor between the Trims and GND pins of the module.

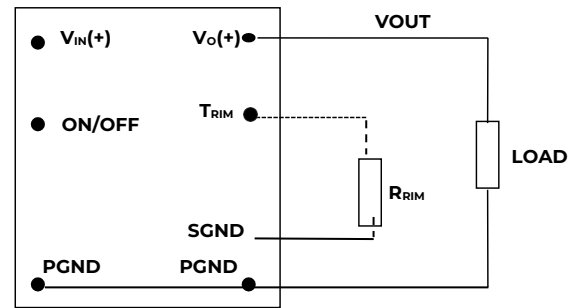

Figure28. Circuit configuration for programming output voltage using an external resistor.

Without an external resistor between TRIM and sGND pins, each output of the module will be the same as input voltage. The value of the trim resistor, Rtrim for a desired output voltage, should be as per the following equation:

$$R_{trim} = \left[\frac{1.2}{(V_o - 1.2)} \right] \times 200.5 \text{ k}\Omega$$

Rtrim is the external resistor in kΩ

Vo is the desired output voltage.

| V _{o,set} (V) | R _{trim} (kΩ) |
|------------------------|------------------------|
| 32 | 7.812 |
| 40 | 6.201 |
| 48 | 5.141 |
| 54 | 4.557 |

Table 1 Trim Resistor (1% resolution or better)

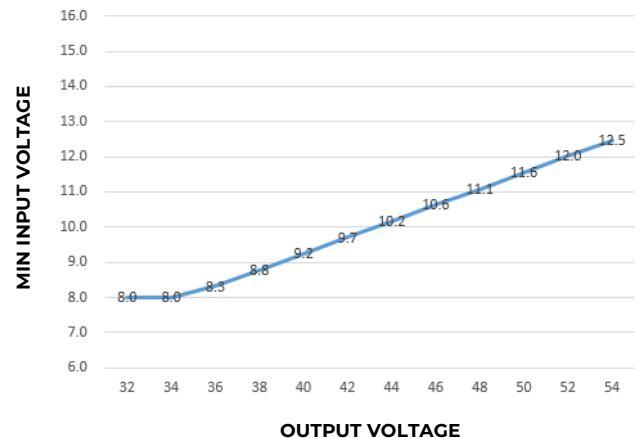

Figure 29. Output Voltages vs. Input Voltage Set point Area plot showing limits where the output voltage can be set for different input voltages

Technical Specifications (continued)

Analog Feature Descriptions (continued)

Remote Sense

The power module has a Remote Sense feature to minimize the effects of distribution losses by regulating the voltage between the sense pin. The voltage drops between the sense pin and VOUT pin should not exceed 0.5V.

Analog Voltage Margining

Output voltage margining can be implemented in the module by connecting a resistor, $R_{margin-up}$, from the T_{rim} pin to the ground pin for margining-up the output voltage and by connecting a resistor, $R_{margin-down}$, from the Trim pin to output pin for margining-down. Figure 30 shows the circuit configuration for output voltage margining. The POL Programming Tool, available at omnionpower.com under the Downloads section, also calculates the values of $R_{margin-up}$ and $R_{margin-down}$ for a specific output voltage and % margin. Please consult your local OmniOn Critical Power technical representative for additional details

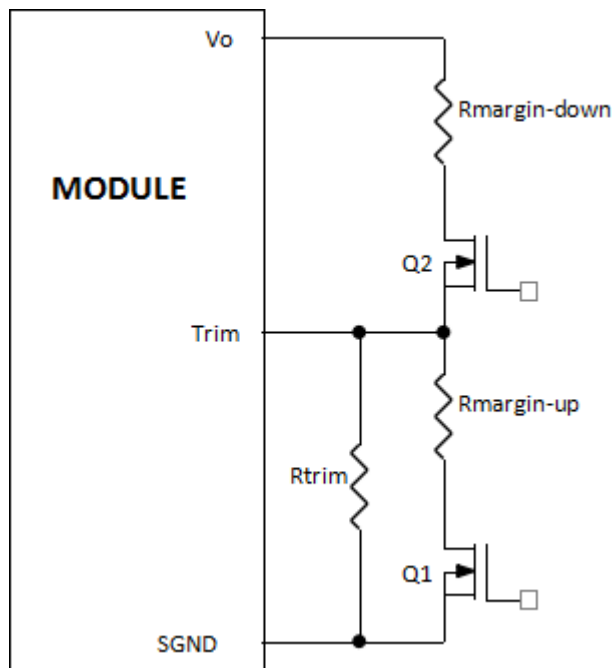

Figure 30. Circuit Configuration for margining Output voltage.

Overcurrent Protection

To provide protection in a fault (output overload) condition, the unit is equipped with internal current-limiting circuitry and can endure current limiting continuously. At the point of current-limit inception, the unit enters hiccup mode. The unit operates normally once the output current is brought back into its specified range.

Overtemperature Protection

To provide protection in a fault condition, the unit is equipped with a thermal shutdown circuit. The unit will shut down if the overtemperature threshold of 135°C(typ) is exceeded at the thermal reference point T_{ref} .

Once the unit goes into thermal shutdown it will then wait to cool before attempting to restart.

Input Undervoltage Lockout

At input voltages below the input undervoltage lockout limit, the module operation is disabled. The module will begin to operate at an input voltage above the undervoltage lockout turn-on threshold.

Tunable Loop™

The module has a feature that optimizes transient response of the module called Tunable Loop™.

External capacitors are usually added to the output of the module for two reasons: to reduce output ripple and noise (see Figure 26) and to reduce output voltage deviations from the steady-state value in the presence of dynamic load current changes. Adding external capacitance however affects the voltage control loop of the module, typically causing the loop to slow down with sluggish response. Larger values of external capacitance could also cause the module to become unstable.

The Tunable Loop™ allows the user to externally adjust the voltage control loop to match the filter network connected to the output of the module. The Tunable Loop™ is implemented by connecting a series R-C between the VOUT and TRIM pins of the module, as shown in Fig. 31. This R-C allows the user to externally adjust the voltage loop feedback compensation of the module.

Technical Specifications (continued)

Analog Feature Descriptions (continued)

Tunable Loop™ (continued)

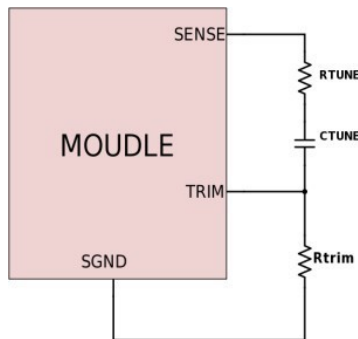

Figure 31. Circuit diagram showing connection of R_{TUNE} and C_{TUNE} to tune the control loop of the module

Please contact your OmniOn Critical Power technical representative to obtain more details of this feature as well as for guidelines on how to select the right value of external R-C to tune the module for best transient performance and stable operation for other output capacitance values.

| C_o | 200 μ F | 300 μ F | 400 μ F | 500 μ F | 600 μ F |
|------------|-------------|-------------|-------------|-------------|-------------|
| R_{TUNE} | 274k | 274k | 274k | 200k | 200k |
| C_{TUNE} | 470p | 470p | 470p | 470p | 1000p |

Table 2. General recommended values of R_{TUNE} and C_{TUNE} for $V_{in}=12V$ and various external ceramic capacitor combinations. $V_o=40V$

| V_{in} | 12V | | | |
|------------|------------------|------------------|-----------------|-----------------|
| V_o | 32V | 40V | 48V | 54V |
| ΔI | 2A | 1.6A | 1.35A | 1.2A |
| C_o | 9x10uF + 1x680uF | 9x10uF + 1x680uF | 9x10uF+ 1x680uF | 9x10uF+ 1x680uF |
| R_{TUNE} | 200k Ω | 200k Ω | 200k Ω | 274k Ω |
| C_{TUNE} | 470pF | 470pF | 470pF | 470pF |
| ΔV | 256mV | 432mV | 566mV | 769mV |

Table 3. Recommended values of R_{TUNE} and C_{TUNE} to obtain transient deviation of 2% of V_{out} for a 50% full load step load with $V_{in}=12V$

Power Good

The module provides a Power Good (PGOOD) signal that is implemented with an open-drain output to indicate that the output voltage is within the regulation limits of the power module.

The PGOOD signal will be de-asserted to a low state if any condition such as overtemperature, overcurrent or loss of regulation occurs that would

result in the output voltage going outside the specified thresholds.

The PGOOD terminal can be connected through a pullup resistor (suggested value 10k Ω) to a source of 5V_{DC} or lower.

Thermal Considerations

Power modules operate in a variety of thermal environments; however, sufficient cooling should always be provided to help ensure reliable operation.

Considerations include ambient temperature, airflow, module power dissipation, and the need for increased reliability. A reduction in the operating temperature of the module will result in an increase in reliability. The thermal data presented here is based on physical measurements taken in a wind tunnel. The test set-up is shown in Figure 32. The preferred airflow direction for the module is in Figure 33.

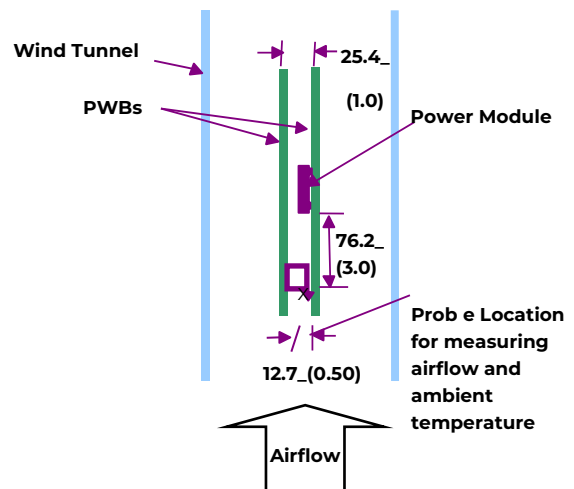

Figure 32. Thermal Test Setup

The thermal reference points, T_{ref} used in the specifications are also shown in Figure 33. For reliable operation the temperatures at the Q1 should not exceed 135°C. The output power of the module should not exceed the rated power of the module

$$(V_{o,set} \times I_{o,max}).$$

Please refer to the Application Note “Thermal Characterization Process For Open-Frame Board-Mounted Power Modules” for a detailed discussion of thermal aspects including maximum device temperatures.

Technical Specifications (continued)

Analog Feature Descriptions (continued)

Thermal Considerations (continued)

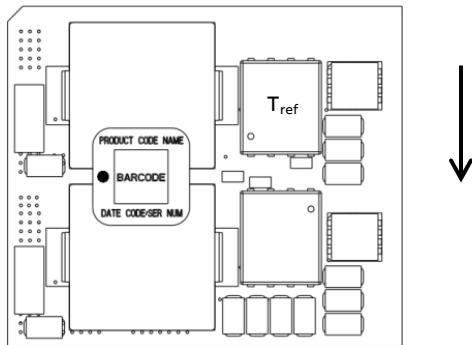

Figure 32. Preferred airflow direction and location of hot-spot of the module (T_{ref}).

Heat Transfer via Conduction

The module can also be used in a sealed environment with cooling via conduction from the module's top surface through a gap pad material to a coldwall, as shown below.

Thermal pad: Bergquist P/N: GP2500S20

Gap filler: Bergquist P/N: GF2000

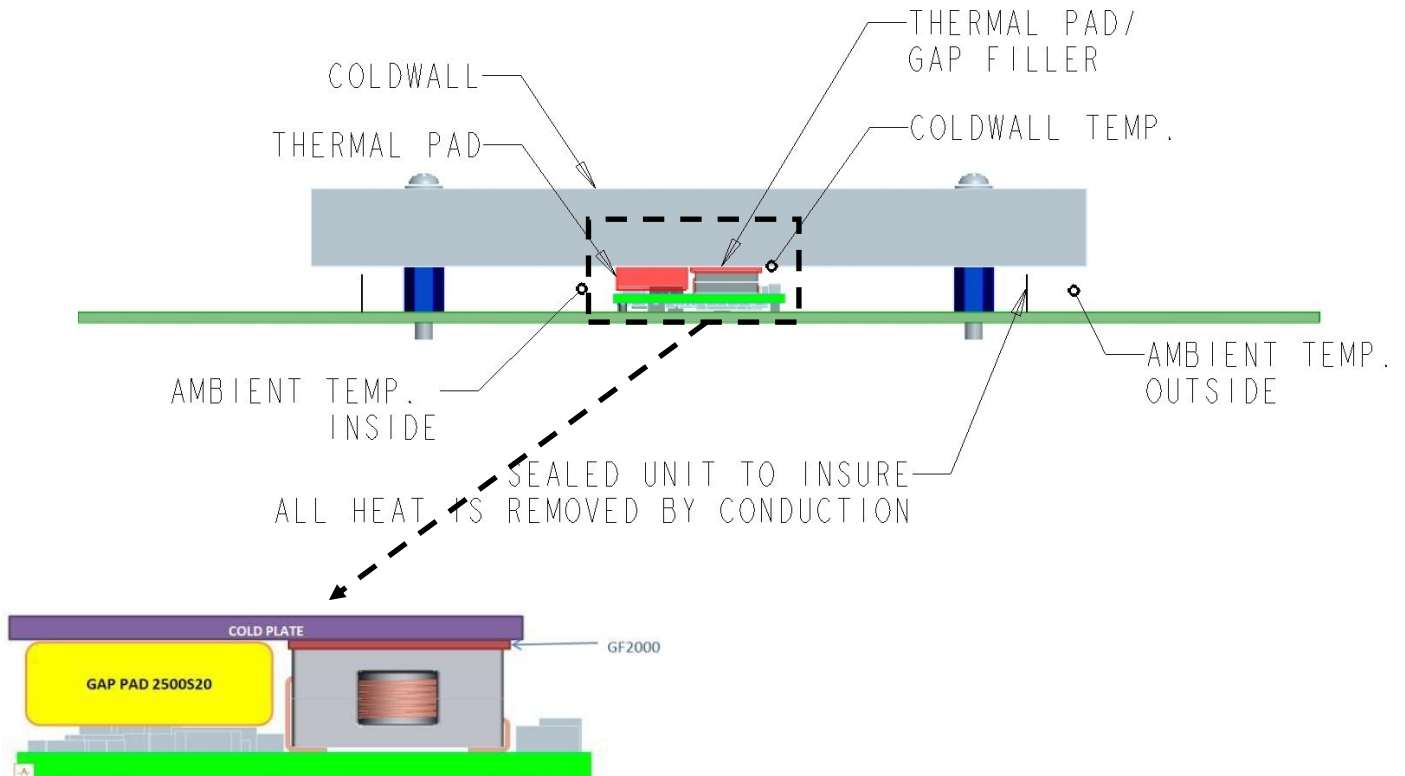

Technical Specifications (continued)

Example Application Circuit

Requirements:

| | |
|--------------------|--|
| V_{in} : | 12V (Note: Two VIN-PGND ports must all connected to external power source) |
| V_{out} : | 1.8V |
| I_{out} : | 2.7A max., worst case load transient is from 2.2A to 3.4A |
| ΔV_{out} : | 1.5% of V_{out} (420mV) for worst case load transient |
| $V_{in, ripple}$: | 1.5% of V_{in} (180mV, p-p) |

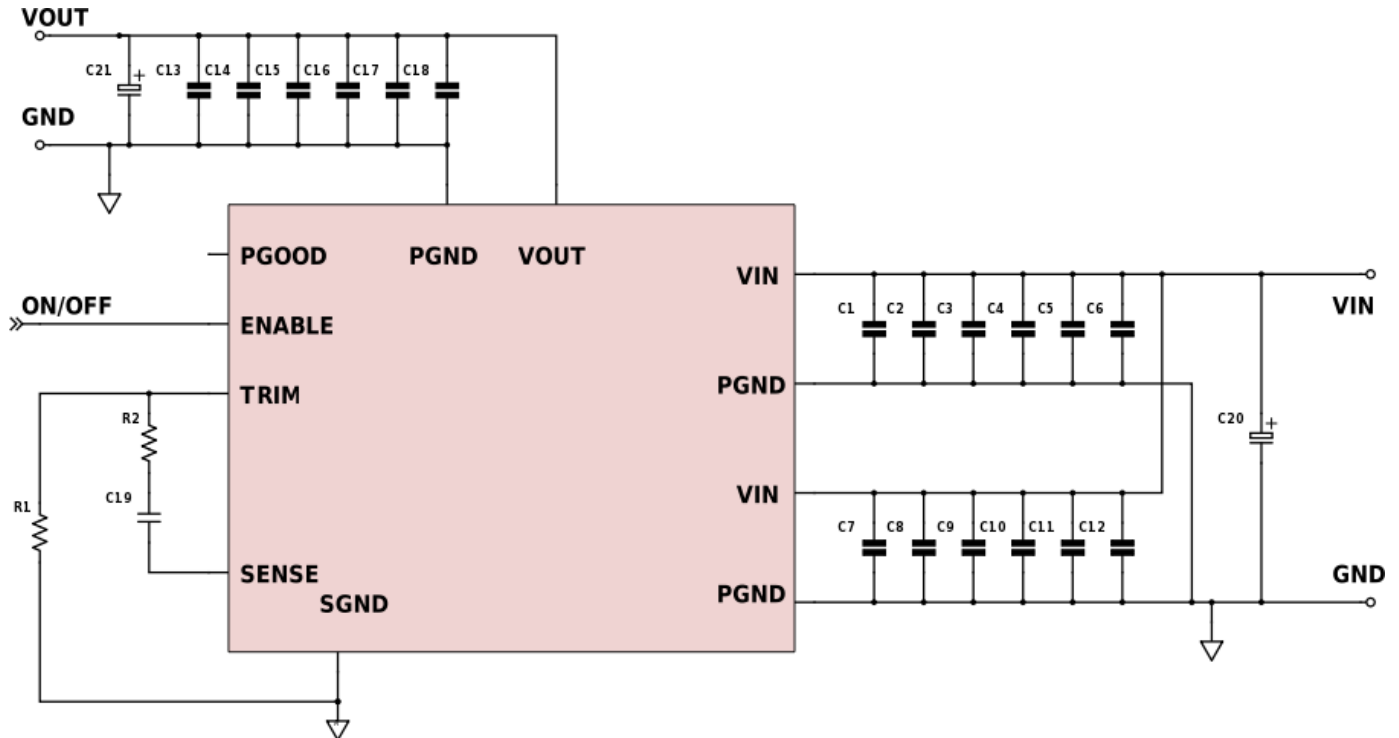

| | |
|--------------------|---|
| C2-C6, C8-C12 | 4.7 μ F/25V, 1210 ceramic capacitor |
| C1, C7 | 0.047 μ F/50V, 0603 ceramic capacitor |
| C20 | 470 μ F/25V, bulk electrolytic |
| C13-C17 | 4.7 μ F/50V, 1210 ceramic capacitor |
| C18 | 0.01 μ F/100V, 0805 ceramic capacitor |
| C21 | 470 μ F/100V, bulk electrolytic |
| R1 | 5.11k Ω |
| C19 (C_{Tune}) | 470pF/100V ceramic capacitor (can be 1206, 0805 or 0603 size) |
| R2 (R_{Tune}) | 200k Ω SMT resistor (can be 1206, 0805 or 0603 size) |

Technical Specifications (continued)

Mechanical Outline

Dimensions are in millimeters and (inches).

Tolerances: x.x mm ± 0.5 mm (x.xx in. ± 0.02 in.)

x.xx mm ± 0.25 mm (x.xxx in ± 0.010 in.)

[unless otherwise indicated]

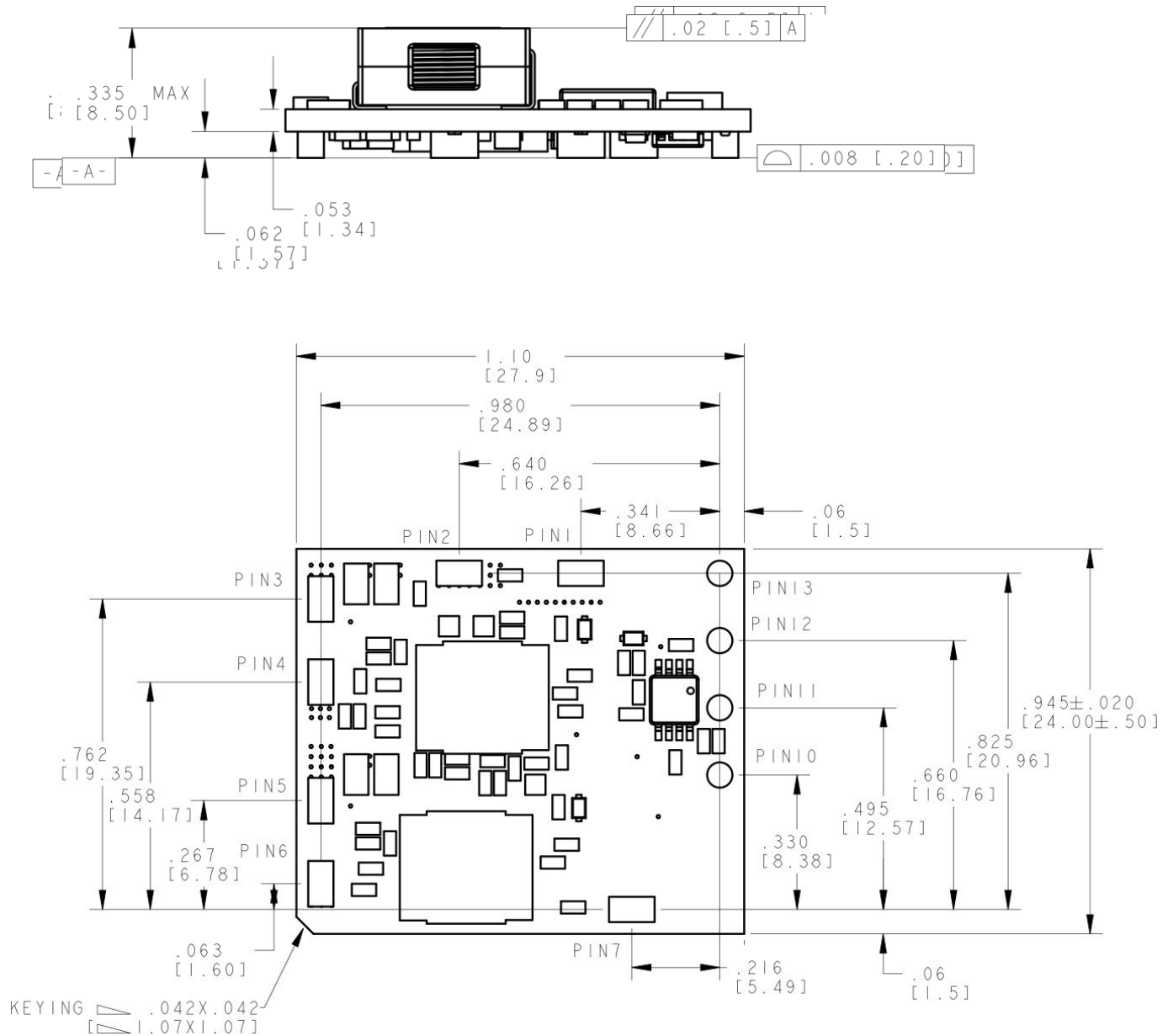

Technical Specifications (continued)

Recommended Pad Layout

Dimensions are in millimeters and (inches).

Tolerances:

x.x mm \pm 0.5 mm (x.xx in. \pm 0.02 in.) [unless otherwise indicated]

x.xx mm \pm 0.25 mm (x.xxx in \pm 0.010 in.)

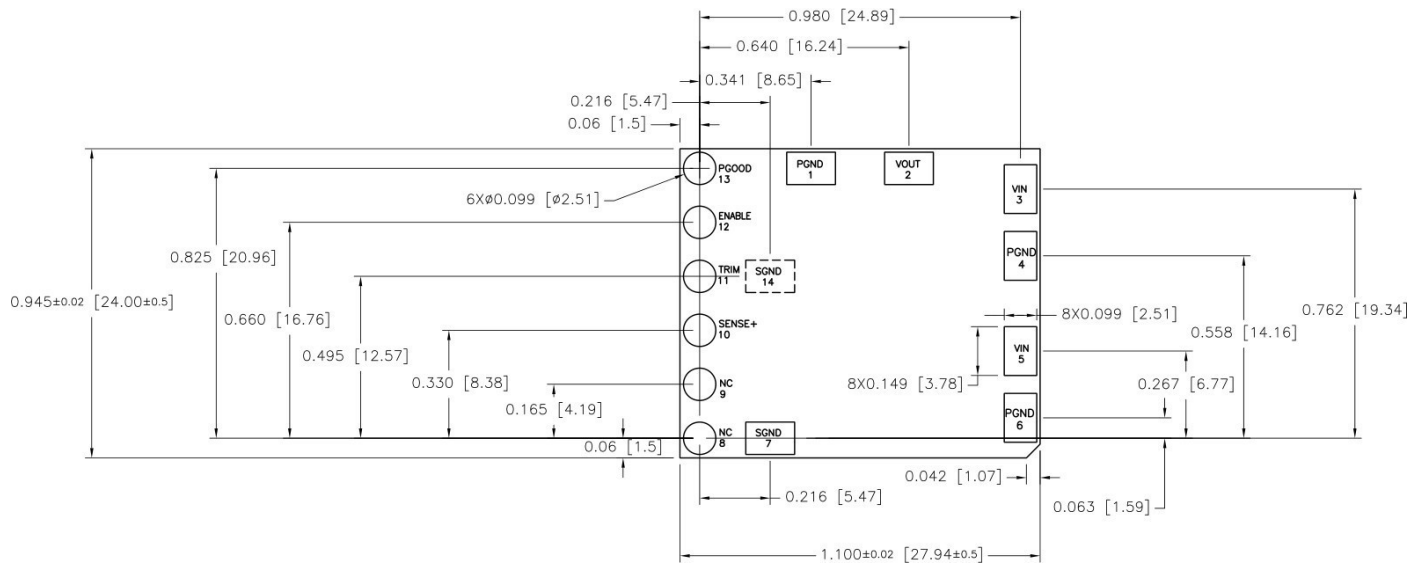

| PIN | FUNCTION | PIN | FUNCTION |
|-----|------------------|-----|----------|
| 1 | PGND | 8 | NC |
| 2 | V _{OUT} | 9 | NC |
| 3 | V _{IN} | 10 | SENSE+ |
| 4 | PGND | 11 | TRIM |
| 5 | V _{IN} | 12 | ENABLE |
| 6 | PGND | 13 | PGOOD |
| 7 | SGND | 14* | SGND |

*PIN 14 is an optional pad, only need if you want this footprint can also cover the 65W Boost PoL (ABXS001/002)

Both pairs of input power pins (3, 4, 5, and 6) must be used

Technical Specifications (continued)

Packaging Details

The ABXS003 Open Frame modules are supplied in tape & reel as standard.
 Modules are shipped in quantities of 150 modules per reel.
 All Dimensions are in millimetres.

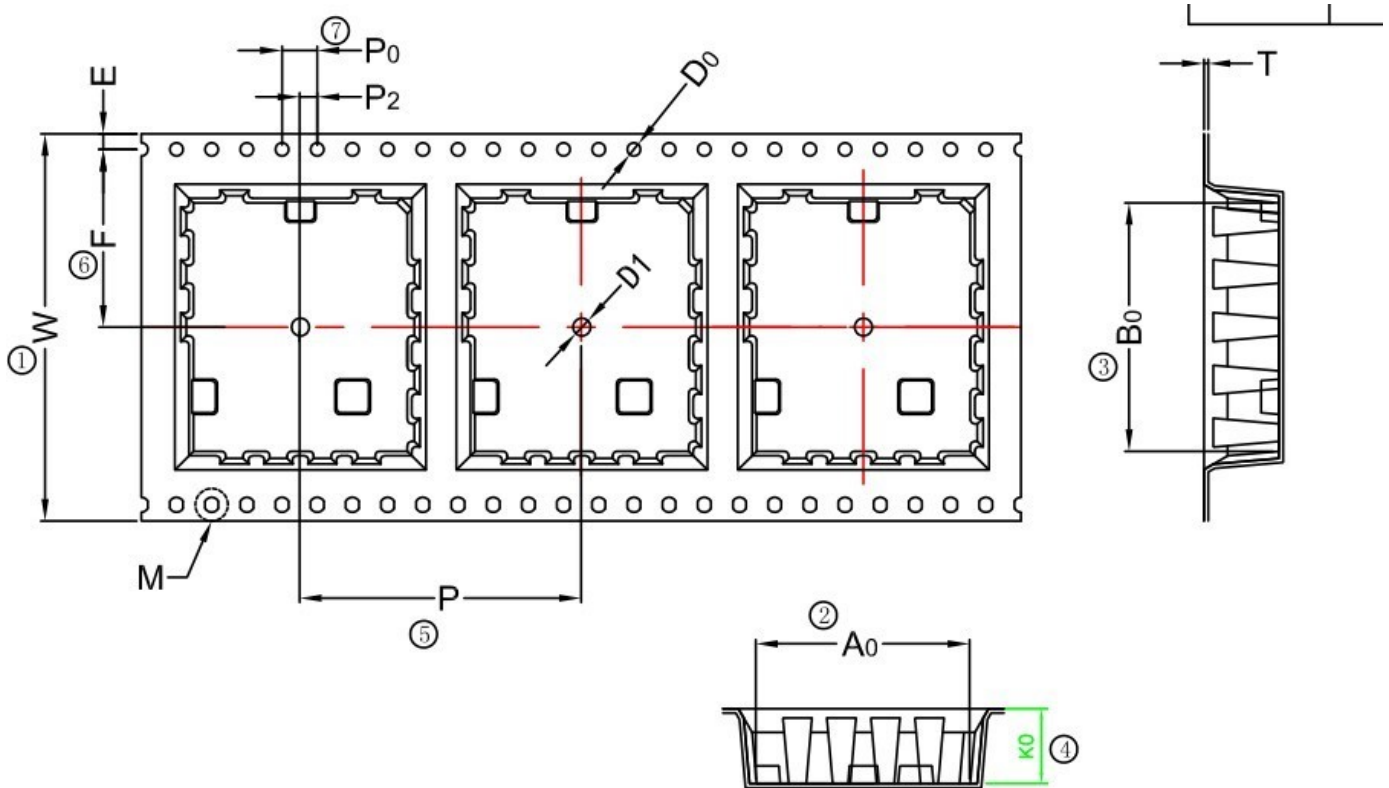

| ITEM | W | A0 | B0 | K0 | K1 | P | F | E | S0 | D0 | D1 | P0 | P2 | T |
|------|-------------------------|------------------------|-------------------------|-----------------------|----|-------------------------|------------------------|------------------------|----|-----------------------|------------------------|------------------------|------------------------|-----------------------|
| DIM | $44.00^{+0.30}_{-0.30}$ | $24.3^{+0.10}_{-0.10}$ | $28.24^{+0.10}_{-0.10}$ | $8.5^{+0.10}_{-0.10}$ | | $32.00^{+0.10}_{-0.10}$ | $20.2^{+0.10}_{-0.10}$ | $1.75^{+0.10}_{-0.10}$ | | $1.5^{+0.10}_{-0.00}$ | $2.00^{+0.10}_{-0.10}$ | $4.00^{+0.10}_{-0.10}$ | $2.00^{+0.10}_{-0.10}$ | $0.4^{+0.05}_{-0.05}$ |

Technical Specifications (continued)

Surface Mount Information

Pick and Place

The ABXS003 Open Frame modules use an open frame construction and are designed for a fully automated assembly process. The modules are fitted with a label designed to provide a large surface area for pick and place operations. The label meets all the requirements for surface mount processing, as well as safety standards, and is able to withstand reflow temperatures of up to 300°C. The label also carries product information such as product code, serial number and the location of manufacture.

Stencil and Nozzle Recommendations

Stencil thickness of 6 mils minimum must be used for this product. The module weight has been kept to a minimum by using open frame construction. Variables such as nozzle size, tip style, vacuum pressure and placement speed should be considered to optimize this process. The minimum recommended inside nozzle diameter for reliable operation is 3mm. The maximum nozzle outer diameter, which will safely fit within the allowable component spacing, is 7 mm.

Lead Free Soldering

The modules are lead-free (Pb-free) and RoHS compliant and fully compatible in a Pb-free soldering process. Failure to observe the instructions below may result in the failure of or cause damage to the modules and can adversely affect long-term reliability.

Pb-free Reflow Profile

Power Systems will comply with J-STD-020 Rev. D (Moisture/Reflow Sensitivity Classification for Nonhermetic Solid State Surface Mount Devices) for both Pb-free solder profiles and MSL classification procedures. This standard provides a recommended forced-air-convection reflow profile based on the volume and thickness of the package (table 4-2). The suggested Pb-free solder paste is Sn/Ag/Cu (SAC). The recommended linear reflow profile using Sn/Ag/Cu solder is shown in Fig. 35. Soldering outside of the recommended profile requires testing to verify results and performance.

MSL Rating

The ABXS003 Open Frame modules have a MSL rating of 2a

Storage and Handling

The recommended storage environment and handling procedures for moisture-sensitive surface mount packages is detailed in J-STD-033 Rev. A (Handling, Packing, Shipping and Use of Moisture/Reflow Sensitive Surface Mount Devices). Moisture barrier bags (MBB) with desiccant are required for MSL ratings of 2 or greater. These sealed packages should not be broken until time of use. Once the original package is broken, the floor life of the product at conditions of $\leq 30^{\circ}\text{C}$ and 60% relative humidity varies according to the MSL rating (see J-STD-033A). The shelf life for dry packed SMT packages will be a minimum of 12 months from the bag seal date, when stored at the following conditions: $< 40^{\circ}\text{C}$, $< 90\%$ relative humidity.

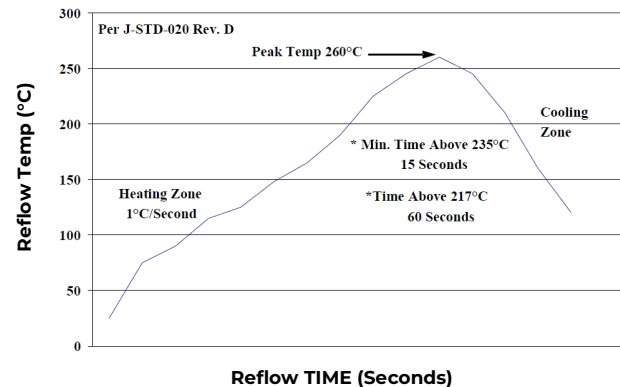

Figure 35. Recommended linear reflow profile using Sn/Ag/Cu solder.

Post Solder Cleaning and Drying Considerations

Post solder cleaning is usually the final circuit-board assembly process prior to electrical board testing. The result of inadequate cleaning and drying can affect both the reliability of a power module and the testability of the finished circuit-board assembly. For guidance on appropriate soldering, cleaning and drying procedures, refer to Board Mounted Power Modules: Soldering and Cleaning Application Note (AN04-001).

Technical Specifications (continued)

Ordering Information

Please contact your OMNION Sales Representative for pricing, availability and optional features.

| Device Code | Input Voltage Range | Output Voltage | Output Current | On/Off Logic | Ordering Code |
|-------------------|-----------------------|------------------------|----------------|--------------|---------------|
| ABXS003A3X341-SRZ | 8 – 16V _{dc} | 32 – 54V _{dc} | 3.3A (40V) | Negative | 1600096705A |

Table 4. Device Codes

-Z refers to RoHS compliant Versions

| Package Identifier | Family | Sequencing Option | Input Voltage Range | Output current | Output voltage | On/Off logic | Remote Sense | Special Code | Options | ROHS Compliance |
|------------------------|-------------|----------------------|---------------------|----------------|-----------------------|-------------------------------------|------------------|---------------|---------------------------------|-----------------|
| A | B | X | S | 003A3 | X | | 3 | 41 | -SR | Z |
| A=Non-Isolated, Non-4G | B=Boost POL | X=without sequencing | 8-16V _{dc} | 3.3A | X=programmable output | 4 = positive No entry = negative | 3 = Remote Sense | 24/48V Output | S = Surface Mount R = Tape & | Z = ROHS |

Table 5. Device Codes

Contact Us

For more information, call us at

1-877-546-3243 (US)

1-972-244-9288 (Int'l)

Change History (excludes grammar & clarifications)

| Revision | Date | Description of the change |
|----------|------------|--------------------------------|
| 1.5 | 03/24/2022 | Updated ROHS |
| 1.6 | 11/24/2023 | Updated as per OmniOn template |

OmniOn Power Inc.

601 Shiloh Rd.
Plano, TX USA

omnionpower.com

We reserve the right to make technical changes or modify the contents of this document without prior notice. OmniOn Power does not accept any responsibility for errors or lack of information in this document and makes no warranty with respect to and assumes no liability as a result of any use of information in this document.

We reserve all rights in this document and in the subject matter and illustrations contained therein. Any reproduction, disclosure to third parties or utilization of its contents – in whole or in parts – is forbidden without prior written consent of OmniOn Power. This document does not convey license to any patent or any intellectual property right. Copyright© 2023 OmniOn Power Inc. All rights reserved.