

# RP450 Integrated Pole Mount

## Quick Start Guide

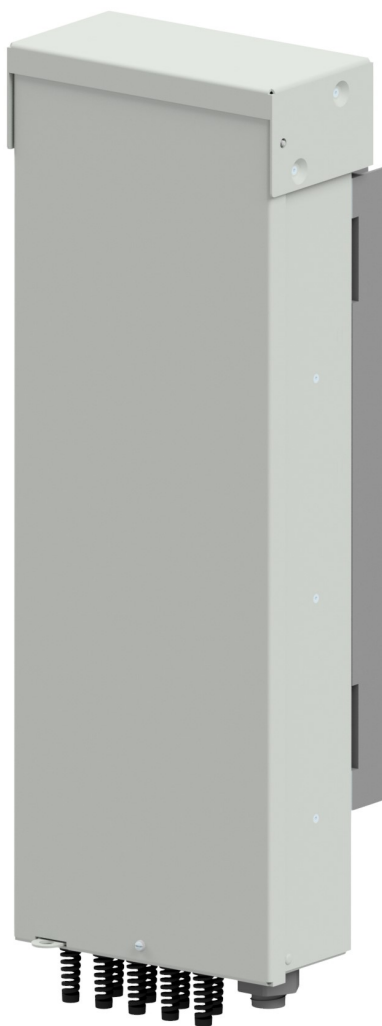

### Important safety instructions

#### Save these instructions

This equipment is not suitable for use in locations where children are likely to be present

Read and follow all safety statements, warnings, and precautions in this manual before installing, maintaining or repairing this equipment.

### consignes de sécurité importantes

#### Conservez ces instructions

Cet équipement n'est pas adapté à une utilisation dans des endroits où des enfants sont susceptibles d'être présents

Lisez et suivez toutes les consignes de sécurité, les avertissements et les précautions de ce manuel avant d'installer, d'entretenir ou de réparer cet équipement.

# Contents

<b>Important Safety Instructions</b> .....	<b>4</b>
<b>Consignes de sécurité importantes</b> .....	<b>5</b>
<b>Precautions</b> .....	<b>6</b>
<b>Précautions</b> .....	<b>7</b>
<b>Safety</b> .....	<b>8</b>
<b>Sécurité</b> .....	<b>8</b>
<b>Equipment Identification</b> .....	<b>8</b>
<b>Introduction</b> .....	<b>9</b>
<b>Information - Tools Required</b> .....	<b>10</b>
<b>Check for deliveries</b> .....	<b>10</b>
<b>Step 1 - Mount unit to Pole</b> .....	<b>11</b>
<b>Step 2 - Ground the Unit</b> .....	<b>12</b>
<b>Step 3 - Open the door and remove dead-fronts for access to field wiring</b> .....	<b>12</b>
<b>Information - Strain Relief Detail for output wiring</b> .....	<b>13</b>
<b>Step 4 - Wire the DC Output</b> .....	<b>14</b>
For DC Breaker Version .....	<b>14</b>
For DC GMT Fuse Version .....	<b>14</b>
<b>Step 5 - Wire the Alarms</b> .....	<b>15</b>
<b>Step 6 - Wire the AC Input</b> .....	<b>15</b>
Configured as Service Entrance .....	<b>15</b>
Not Configured as Service Entrance.....	<b>15</b>
<b>Step 7 - Final wire Dressing and Close the Door</b> .....	<b>17</b>
<b>Step 8 - Apply AC Power and Confirm -48V Power</b> .....	<b>17</b>
<b>Information - Electrical Connections</b> .....	<b>18</b>
Alarm Terminal Blocks.....	<b>18</b>
DC Output Connections.....	<b>18</b>
AC Input Connections .....	<b>19</b>
Configured as Service Entrance .....	<b>19</b>
Not Configured as Service Entrance.....	<b>19</b>
<b>Information - LED States</b> .....	<b>19</b>
<b>Information - External electrical equipment</b> .....	<b>20</b>
<b>Information - Lifting the Unit</b> .....	<b>20</b>
<b>Information - External Icing</b> .....	<b>20</b>
<b>Information - for Retrofit Applications</b> .....	<b>20</b>
<b>Information - Touch Up Paint</b> .....	<b>20</b>
<b>Parts List</b> .....	<b>21</b>
<b>Specifications and Application</b> .....	<b>21</b>
<b>Ordering Information</b> .....	<b>21</b>
<b>Change History</b> .....	<b>22</b>
<b>Disclaimer</b> .....	<b>23</b>

## List of Figures

Figure 1 Warning Label.....	8
Figure 2 Product ID Label Information.....	8
Figure 3 Mounting unit to pole .....	11
Figure 4 Unit Grounding.....	12
Figure 5 AC/DC Field wiring .....	12
Figure 6 Upper and lower dead front screws .....	12
Figure 7 chamber wiring.....	13
Figure 8 Strain Relief for output wiring.....	13
Figure 9 DC Output wiring .....	14
Figure 10 Pluggable terminal block.....	15
Figure 11 AC Feed .....	15
Figure 12 AC Input Wiring .....	16
Figure 13 Final Wire Dressing .....	17
Figure 14 Alarm Connections.....	18
Figure 15 DC output connections.....	18
Figure 16 AC Input connections.....	19

## Important Safety Instructions

1. SAVE THESE INSTRUCTIONS – This document contains important safety and operating instructions for the Repeater Power Pole Mount System
2. Before using the Repeater Power Pole Mount System, read all instructions and cautionary markings on the AC feed equipment and the radio/repeater, and all other connected equipment.
3. Rules and Regulations - Follow all national and local rules and regulations when making field connections.
4. Field-wired Conductors - Follow all National Electric Code (NEC) and local rules and regulations.
  - a. Insulation rating: 90°C minimum; if internal to enclosed equipment cabinets.
  - b. Size AC field-wired conductors with 75°C ampacity (NEC) equal to or greater than their panel board circuit breaker rating. 12-8 AWG copper wire.
  - c. Size DC field-wired conductors with 90°C ampacity (NEC) equal to or greater than 30A .
5. AC input disconnect/protection – If an external AC service entrance is configured, provide accessible devices to remove input power in an emergency.
6. Compression Connectors
  - a. U. S. or Canada installations - use Listed/Certified compression connectors to terminate Listed/Certified field-wire conductors.
  - b. All installations - apply the appropriate connector to the correct size conductor as specified by the connector manufacturer, using only the connector manufacturer’s recommended or approved tooling for that connector.
7. Electrical Connection Securing: Torque to the values specified on labels or in the product documentation.
8. Cable Dress - dress to avoid damage to the conductors and undue stress on the connectors. Always provide a drip loop to shed water off cables before they enter the strain reliefs.
9. Alarm Signals - Provide external current limiting protection. Rating - 60V, 0.5A unless otherwise noted.
10. Grounding - Connect the equipment chassis directly to ground.
11. This equipment is to be mounted directly and permanently above non-combustible surface, such as concrete or metal.
12. WARNING: Equipment is not designed to charge an external battery source.
13. This equipment is not suitable for use in locations where children are likely to be present

## Consignes de sécurité importantes

1. CONSERVEZ CES INSTRUCTIONS - Ce document contient des instructions de sécurité et d'utilisation importantes pour le système de montage sur poteau d'alimentation du répéteur
2. Avant d'utiliser le système de montage sur poteau d'alimentation du répéteur, lisez toutes les instructions et les mises en garde sur l'équipement d'alimentation CA et sur la radio/le répéteur, ainsi que sur tous les autres équipements connectés.
3. Règles et réglementations - Suivez toutes les règles et réglementations nationales et locales lors des connexions sur le terrain.
4. Conducteurs câblés sur le terrain - Suivez tous les codes électriques nationaux (NEC) et les règles et réglementations locales.
  - a. Indice d'isolation : 90 °C minimum ; s'il est interne à des armoires d'équipement fermées.
  - b. Dimensionnez les conducteurs CA câblés sur place avec un courant admissible de 75 °C (NEC) égal ou supérieur à la valeur nominale du disjoncteur du panneau de distribution. Fil de cuivre 8 - 12 AWG
  - c. Dimensionnez les conducteurs CC câblés sur place avec un courant admissible à 90 °C (NEC) égal ou supérieur à 30 A .
5. Déconnexion/protection de l'entrée CA – Si une entrée de service CA externe est configurée, fournissez des dispositifs accessibles pour couper l'alimentation d'entrée en cas d'urgence.
6. Connecteurs à compression
  - a. Installations aux États-Unis ou au Canada - utilisez des connecteurs à compression répertoriés/certifiés pour terminer les conducteurs de câbles de terrain répertoriés/certifiés.
  - b. Toutes les installations - appliquez le connecteur approprié au conducteur de taille correcte tel que spécifié par le fabricant du connecteur, en utilisant uniquement l'outillage recommandé ou approuvé par le fabricant du connecteur pour ce connecteur.
7. Fixation de la connexion électrique : Serrez aux valeurs spécifiées sur les étiquettes ou dans la documentation du produit.
8. Habillage de câble - Habillez-vous pour éviter d'endommager les conducteurs et une contrainte excessive sur les connecteurs. Prévoyez toujours une boucle d'égouttement pour évacuer l'eau des câbles avant qu'ils n'entrent dans les serre-câbles.
9. Signaux d'alarme - Fournit une protection de limitation de courant externe. Note - 60V, 0.5A sauf indication contraire.
10. Mise à la terre - Connectez le châssis de l'équipement directement à la terre.
11. Cet équipement doit être monté directement et en permanence au-dessus d'une surface non combustible, comme le béton ou le métal.
12. AVERTISSEMENT : L'équipement n'est pas conçu pour charger une source de batterie externe.
13. Cet équipement ne convient pas à une utilisation dans des endroits où des enfants sont susceptibles d'être présents

## Precautions

- Install, service, and operate equipment only by professional, skilled and qualified personnel who have the necessary knowledge and practical experience with electrical equipment and who understand the hazards that can arise when working on this type of equipment.
- Do not disconnect permanent bonding connections unless all power inputs are disconnected.
- Verify that equipment is properly safety earth grounded before connecting power. High leakage currents may be possible.
- Exercise care and follow all safety warnings and practices when servicing this equipment. Hazardous energy and voltages are present in the unit and on the interface cables and connectors that can shock or cause serious injury.
- Use safe lifting practices. The equipment is heavy. Lifting devices are recommended.
- Use the following precautions in addition to proper job training and safety procedures:
  - Use only properly insulated tools.
  - Remove all metallic objects (key chains, glasses, rings, watches, or other jewelry).
  - Follow Lock Out Tag Out (LOTO) procedures: customer specified, site specific, or general as appropriate.  
Disconnect all power input before servicing the equipment. Check for multiple power inputs.
  - Wear safety glasses.
  - Follow Personal Protective Equipment requirements: customer specified, site specific, or general as appropriate.
  - Test circuits before touching.
  - Be aware of potential hazards before servicing equipment.
  - Identify exposed hazardous electrical potentials on connectors, wiring, etc.
  - Avoid contacting circuits when removing or replacing covers.
  - Use a personal ESD strap when accessing or removing electronic components.
- Personnel with electronic medical devices need to be aware that proximity to DC power and distribution systems can affect medical electronic devices, such as pacemakers. Effects decrease with distance.
- If equipment is mounted 10 ft high or above, use an elevated platform to access equipment.

## Précautions

- Installez, entretenez et utilisez l'équipement uniquement par du personnel professionnel, compétent et qualifié qui possède les connaissances et l'expérience pratique nécessaires avec l'équipement électrique et qui comprend les dangers qui peuvent survenir lors de travaux sur ce type d'équipement.
- Ne déconnectez pas les connexions de liaison permanentes à moins que toutes les entrées d'alimentation ne soient déconnectées.
- Vérifiez que l'équipement est correctement mis à la terre de sécurité avant de brancher l'alimentation. Des courants de fuite élevés peuvent être possibles.
- Soyez prudent et suivez tous les avertissements et pratiques de sécurité lors de l'entretien de cet équipement. Des énergies et des tensions dangereuses sont présentes dans l'unité et sur les câbles d'interface et les connecteurs qui peuvent provoquer des chocs ou des blessures graves.
- Utilisez des pratiques de levage sécuritaires. Le matériel est lourd. Les appareils de levage sont recommandés.
- Utilisez les précautions suivantes en plus de la formation professionnelle appropriée et des procédures de sécurité :
- Utilisez uniquement des outils correctement isolés:
  - Retirez tous les objets métalliques (porte-clés, lunettes, bagues, montres ou autres bijoux).
  - Suivez les procédures LOTO (Lock Out Tag Out) : spécifiées par le client, spécifiques au site ou générales, selon le cas.
  - Débranchez toutes les entrées d'alimentation avant de procéder à l'entretien de l'équipement. Vérifiez les entrées d'alimentation multiples.
  - Portez des lunettes de sécurité.
  - Respectez les exigences relatives à l'équipement de protection individuelle : spécifiées par le client, spécifiques au site ou générales, selon le cas.
  - Testez les circuits avant de toucher.
  - Soyez conscient des dangers potentiels avant de procéder à l'entretien de l'équipement.
  - Identifiez les potentiels électriques dangereux exposés sur les connecteurs, le câblage, etc.
  - Éviter tout contact avec les circuits lors du retrait ou du remplacement des couvercles.
  - Utilisez une sangle ESD personnelle lors de l'accès ou du retrait des composants électroniques.
- Le personnel disposant d'appareils médicaux électroniques doit être conscient que la proximité des systèmes d'alimentation et de distribution CC peut affecter les appareils électroniques médicaux, tels que les stimulateurs cardiaques. Les effets diminuent avec la distance.
- Si l'équipement est monté à 10 pieds de haut ou plus, utilisez une plate-forme surélevée pour accéder à l'équipement.

**QUICK START GUIDE**

**Safety**

Read and follow all safety statements, warnings, and precautions in this manual before installing, maintaining or repairing this equipment.

**Sécurité**

Lisez et suivez toutes les consignes de sécurité, les avertissements et les précautions de ce manuel avant d'installer, d'entretenir ou de réparer cet équipement.

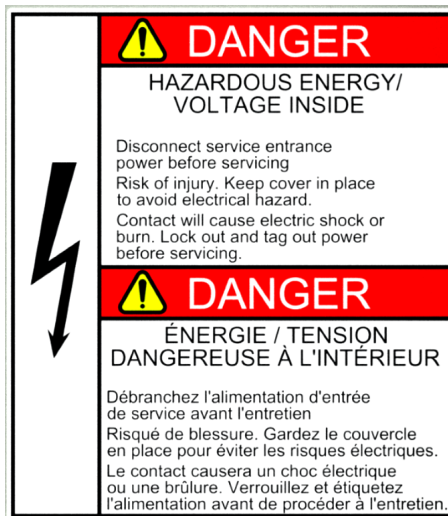
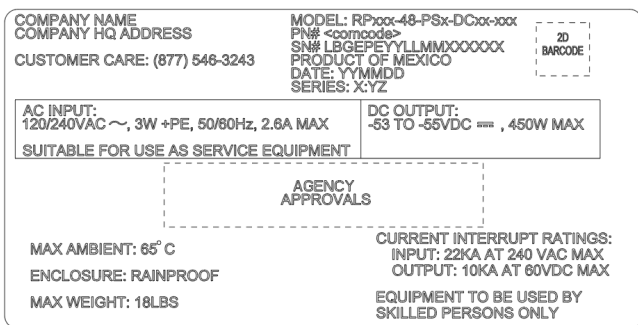

Figure 1 Warning Label

**Equipment Identification**

The product ID label on the front door of the RP450 model is shown below. It includes the product serial number and input - output specifications of the cabinet.

1600361512A, RP450-48-PS1-DC6B-SRG



1600408704A, RP450-48-PS1-DC6F-SRG

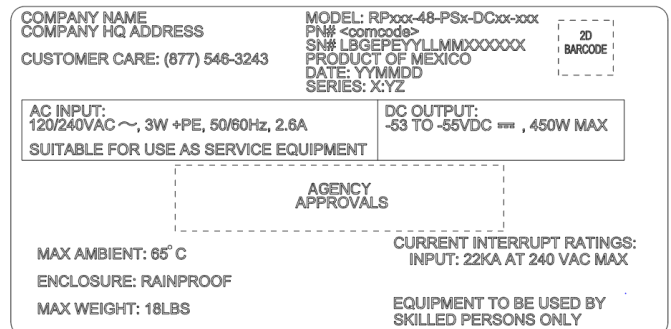

Figure 2 Product ID Label Information

**Customer Care**

+1 877 546-3243

**Reference Documents**

RPxxx-48-PSx-DC6xx-SRG-AD



## Introduction

The repeater power system is an integrated pole mount solution that combines high efficiency rectifier, input AC breaker and Surge Protection, up to six DC output breakers or fuses and DC surge protection in a pole/wall mountable enclosure to simplify small cell / 5G Repeater deployments .

### Basic Features:

- The positive voltage is referenced to ground. The output is – 48V nominal. It is powered off of 120/240V<sub>AC</sub>~3W+PE with operational parameters as shown here: Input: 2.6A @ 120/240V<sub>AC</sub>~3W+PE, Output: 450W Maximum at 54V<sub>DC</sub>, depending on ambient temperature.
- Isolated alarm contacts are available for DC Fault and AC Fault.

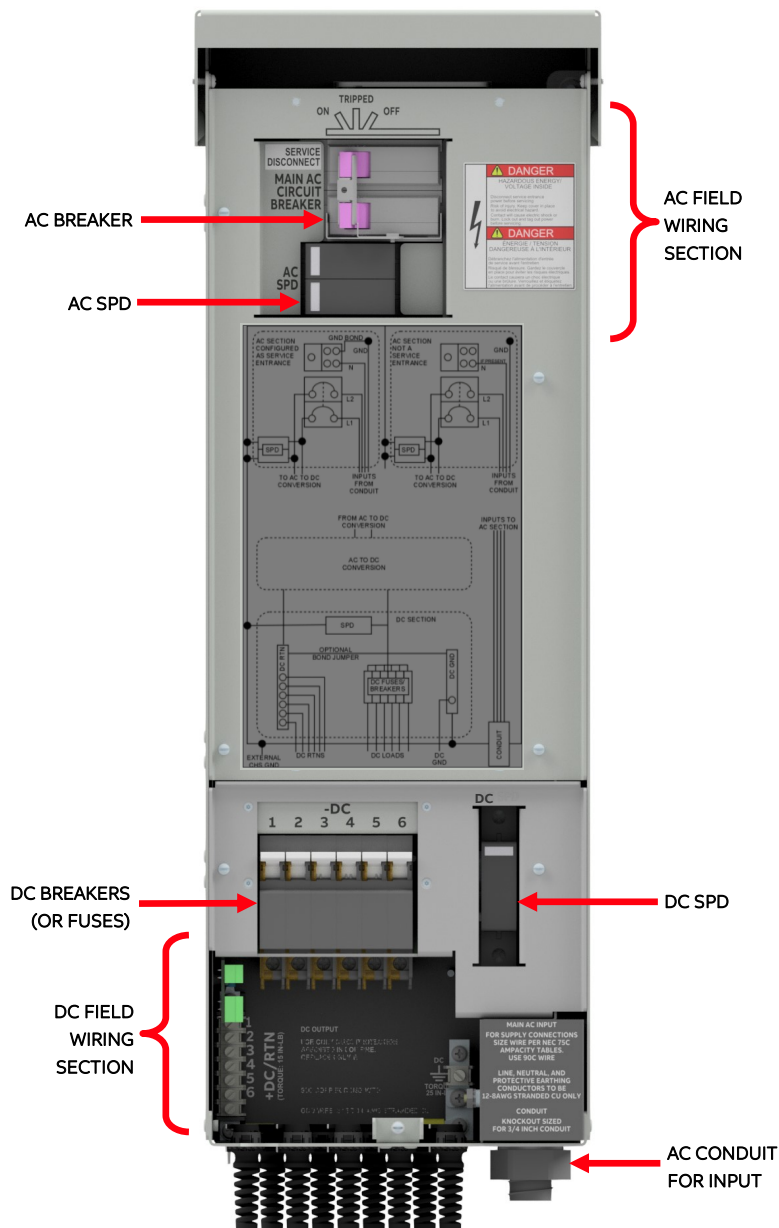

## Information - Tools Required

Regulations, standards, site engineering instructions, MOPs, etc. take precedence over these general installation instructions.

- Steel toed safety shoes
- Wire cutters, strippers, Termination & Channel Lock Tools
- Torque wrench - 0-65 in-lb (0-10 Nm) and 40 ft-lbs
- Volt Meter for Lock-Out Tag-Out procedures.
- Sockets - as needed for mounting hardware
- Screwdrivers - #2 pozi drive screwdriver. Flat and Torx bit set with security pin

## Check for deliveries:

Make sure that the box contains the

- RP450 module
- Installation hardware kit which consists of:
  - 10-32 FLANGE NUT
  - 7 x HOLE PLUG
  - 9 x STRAIN RELIEF
  - 3 x TERMINAL BLOCK, 3 POS
  - LUG, 6AWG, 2 HOLE, #10
  - TERMINAL BLOCK, 2 POS

## Step 1 - Mount unit to pole

**CAUTION:** Use safe lifting practices. Lifting devices are recommended. Steel toed shoes required. The weight of the unit is 18.0 lbs. and the mounting straps and pole must support 3 times the weight of the unit.

When choosing a location, please keep in mind:

- i) The unit must be mounted in “portrait” orientation so that air can flow vertically by natural convection.
- ii) Leave at least 3 inches above and below the unit to allow air to feed the fins and exit from the fins.
- iii) Mount the unit above the flood line. Note: the unit has weep holes at the bottom to equalize pressure and drain any water/condensate that may enter.
- iv) Orient the wiring entrance toward the ground and provide drip loops to shed any water running down the jacket.

### Pole Locations

1. Remove the unit from the packaging
2. Select an elevation and orientation on the pole.

**Note:** Wires must dress out of the bottom of the unit when installed.

**Note:** If the rectifier is being mounted overhead (or above 10 ft.) use a hoist and harness to reduce the chance of serious injury. The recommended harness is approximately a 25 inch loop of 2.5mm diameter Samson Amsteel Blue Dyneema, or equivalent. This loop is made by taking a 55 inch length and joining the ends together via an appropriate knot (Figure 3 or water knot are two suggestions) as shown in the view below.

3. Use ¾” inch wide straps to mount the unit to the pole approximately as show in view to the right.

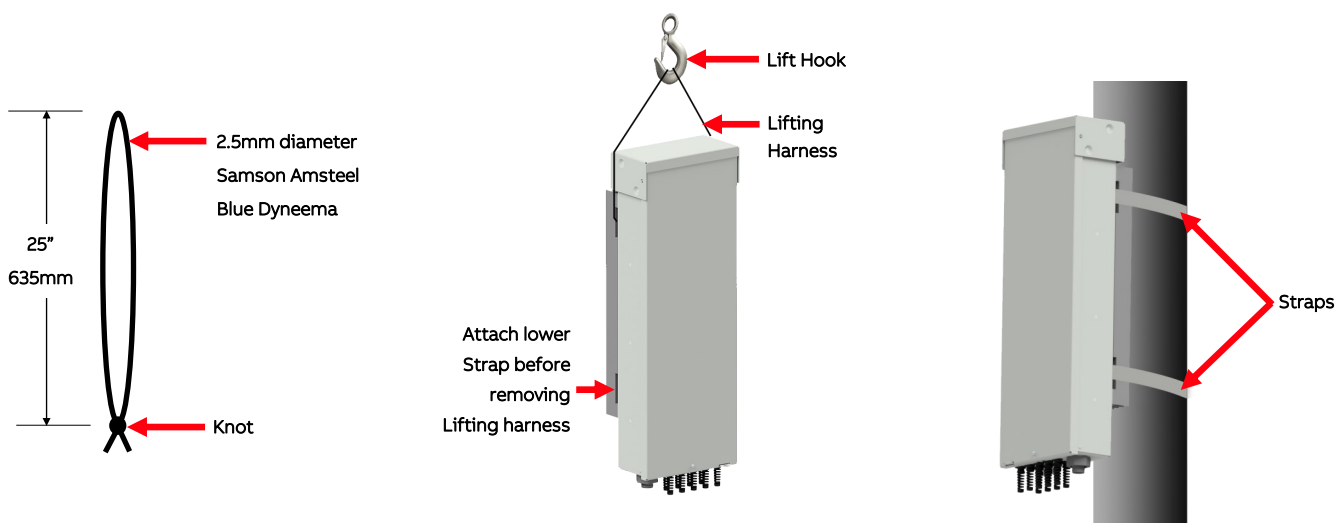

Figure 3 Mounting unit to pole

**QUICK START GUIDE**

**Step 2 - Ground the unit**

There are #10-32 studs on 5/8 centers on the lower back of the unit. Use this location to provide external grounding as required by code or network standard. 8 AWG minimum recommended ground wire.

Torque each nut to 26 in-lbs.

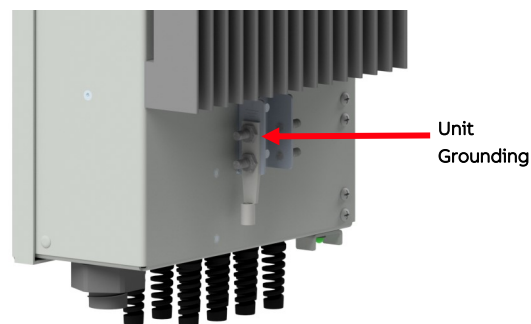

Figure 4 Unit Grounding

**Step 3 - Open the door and remove dead-fronts for access to field wiring**

1. For field wiring, open the front door as shown.

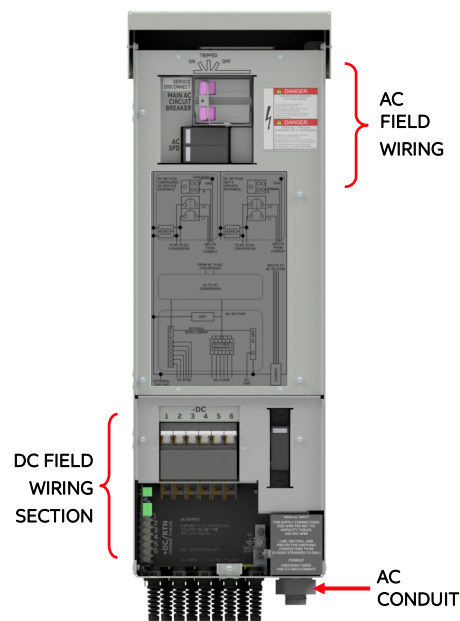

Figure 5 AC/DC Field wiring

2. Use a slotted screwdriver to loosen the 4 captive screws of the upper dead-front cover, then remove the upper dead-front cover.

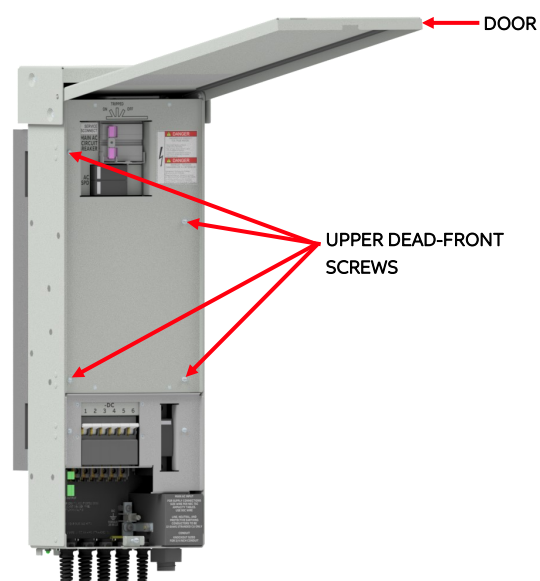

Figure 6 Upper dead front screws

**QUICK START GUIDE**

3. After the dead front cover is removed, open the necessary insulators. Wiring chamber will look like as shown in figure 7. The AC wiring comes in at the bottom and is routed through the channel on the right up to the AC wiring compartment. The DC wiring is connected in the DC wiring compartment and is routed out the bottom through the strain reliefs

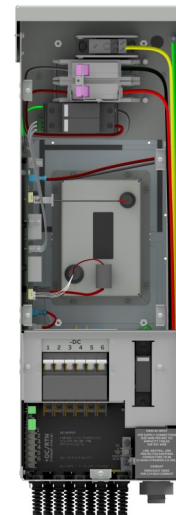

Figure 7 Chamber wiring

**Information - Strain relief detail for output wiring**

There are 9 strain relief attached to unit

- 6 Strain Relief for DC Output wire breakers
- 1 Strain Relief for Signal wires
- 1 Strain Relief for DC Ground
- One unused should be populated with the plug which is part of ship loose kit

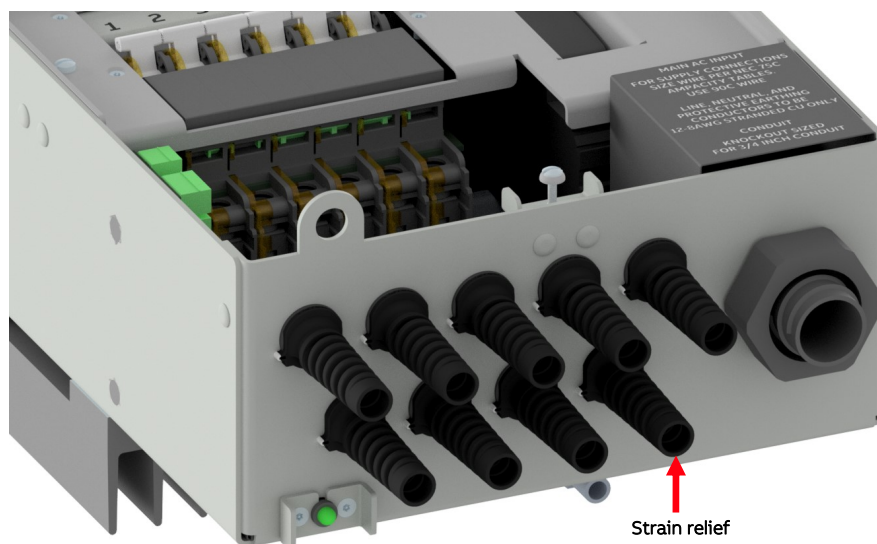

Figure 8 Strain relief for output wiring

**QUICK START GUIDE**

**Step 4 - Wire the DC output**

This unit will accept up to 6 pairs of DC Power wires and a DC ground wire. Terminal block located on the left side of the wiring space. Wiring will be directly to the breakers or to terminal blocks for the fuse option. Select a wire and jacket suitable for the application. The strain relief accepts a range of wire bundle diameters from .220" to .290".

1. Run the DC output cables through the strain relief fittings.
2. If there are more than 2 conductors in the outer jacket, strip the outer jacket to reveal inner jacketed conductors.
3. If there are more than 2 conductors in the jacket, apply 1 inch of heat shrink tubing to the conductor that will be unused, leaving 1/2 inch of free tubing past the end of the conductor to assure that that conductor will never be energized..

**For DC Breaker Version**

4. Strip the inner jacket off the two conductors to expose .5 inches (13mm) of bare conductor to terminate in circuit breaker and 0.6" (16mm) to terminate in return bus terminal block.
5. Connect the first pair of the wires to the first set of + and -48V terminals, toward the left end of the terminal block. One wire carries +. The other carries -48V.

**For DC GMT Fuse Version**

4. Strip the inner jacket off the two conductors to expose .4 inches (9mm) of bare conductor to terminate in circuit breaker and 0.6 inches (16mm) to terminate in return bus terminal block.
5. Connect the first pair of the wires to the first set of + and -48V terminals, toward the left end of the terminal block. One wire carries +. The other carries -48V.

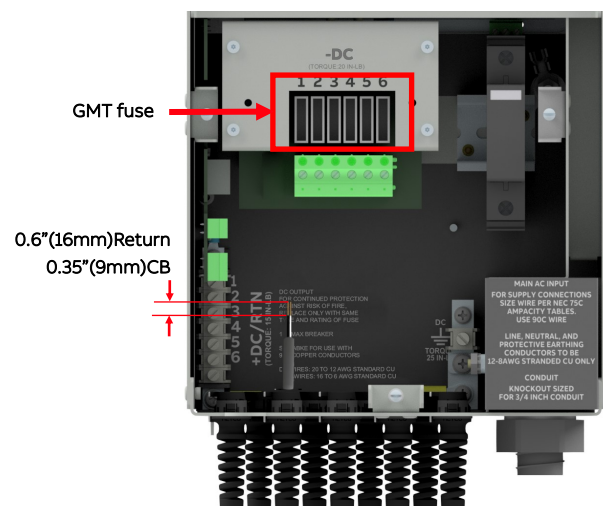
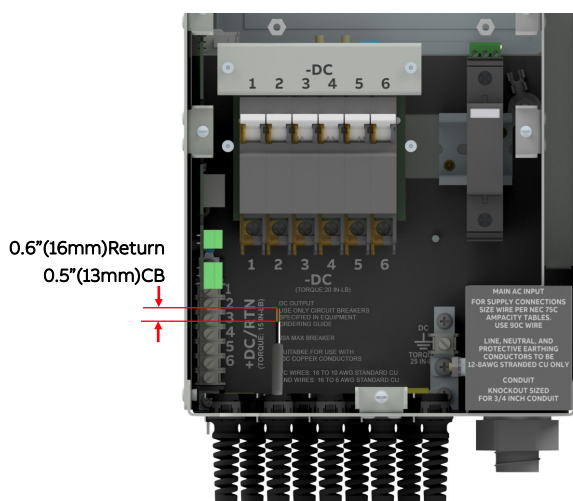

Figure 9 DC Output wiring

QUICK START GUIDE

### Step 5 - Wire the alarms

The unit provides three optional alarm contact closures via three pluggable terminal block and also provides a ground terminal block. See Information Table on sheet 18.

1. Run the alarm wires through the appropriate strain relief fitting.
2. If required, strip the outer jacket to reveal inner jacketed conductors.
3. Strip the inner jacket to expose 0.3 inches (7 mm) of bare conductor
4. Connect the pairs of the wires to the pluggable terminal block. See Information Table on sheet 18.
5. Plug in terminal blocks into the board mounted terminal block bases

**Note:** There is no alarm provision for blown fuse or tripped circuit breaker.

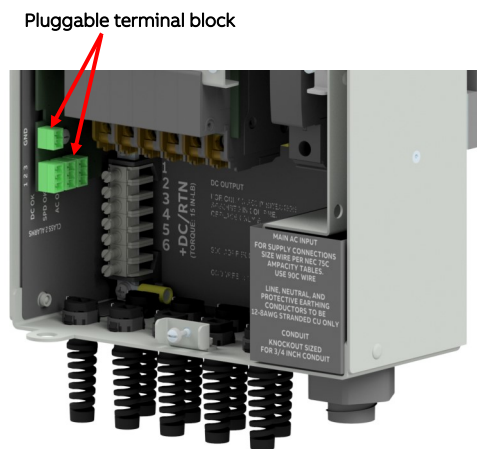

Figure 10 Pluggable terminal block

### Step 6 - Wire the AC input

**Danger:** Shock Hazard - Confirm the AC source is NOT ENERGIZED before making AC connections.

**Danger:** Risque d'électrocution - Vérifiez que la source CA N'EST PAS SOUS TENSION avant d'effectuer les connexions CA.

When connecting to AC mains, follow all local and national wiring rules.

**Caution:** Ensure that wires do not come in contact with sharp or rough surfaces that may damage insulation and cause a short circuit.

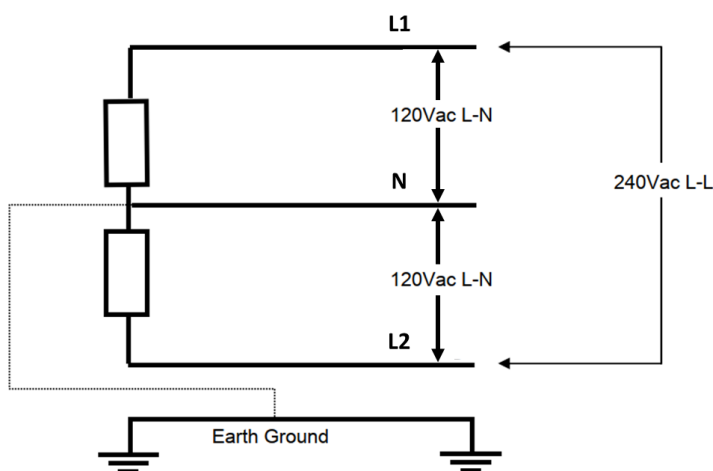

Figure 11 AC Feed

## QUICK START GUIDE

### Verify all AC breakers are off!

The unit's input is designed for up to four 8 AWG conductors to be terminated in the AC mains breaker, neutral terminal block and ground location(s) within the AC termination area at the top of the unit. The AC input is brought into the unit at the bottom of the unit through industry standard ¾" water-tight conduit and the wires are routed up to the top AC termination area.

1. Attached industry standard ¾" water-tight conduit at the bottom of the unit and run the AC input wires through the conduit and route to the top of the unit where the AC termination area is located.
2. Strip the jacket off each of the conductors to expose bare conductor as follows: 0.5 inches (13 mm) for L1 and L2; 0.35 inches (9 mm) Neutral and Ground

#### Configured as Service Entrance

3. Connect the ground wire to the chassis stud with the provided ring terminal. Torque the nut to 30 in-lbs.
4. Connect provided bond wire between neutral bus assembly and chassis stud. Torque the terminal block screw to 25 in-lbs using a flat bladed screw driver and 30 in-lb on the chassis stud.
5. Connect neutral conductor to the grounded terminal block. Torque the terminal block screw to 25 in-lbs using a flat bladed screw driver.
6. Pull wire to verify.
7. Connect the Line 1 wire to the lower position of the 2-pole circuit breaker. Refer figure 12.
8. Torque the screw compression fitting to 35 in-lb for 10 AWG or smaller, 40 in-lb for 8 AWG using a flat bladed screw driver.
9. Pull wire to verify.
10. Connect the Line 2 wire to the upper position of the 2-pole circuit breaker. Refer figure 12.
11. Torque the screw compression fitting to 35 in-lb for 10 AWG or smaller, 40 in-lb for 8 AWG using a flat bladed screw driver.
12. Pull wire to verify.

#### Not Configured as Service Entrance

3. N/A
4. Connect the ground wire to the chassis stud with the provided ring terminal. Torque the nut to 30 in-lbs.
5. The neutral wire should be terminated/grounded at the external service entrance. However, if neutral conductor is brought into this unit it can be terminated to the floating neutral terminal block. Torque the terminal block screw to 25 in-lbs. using a flat bladed screw driver.
6. Pull wire to verify.
7. Connect the Line 1 wire to the lower position of the 2-pole circuit breaker. Refer figure 12.
8. Torque the screw compression fitting to 35 in-lb for 10 AWG or smaller, 40 in-lb for 8 AWG using a flat bladed screw driver.
9. Pull wire to verify.
10. Connect the Line 2 wire to the upper position of the 2-pole circuit breaker. Refer figure 12.
11. Torque the screw compression fitting to 35 in-lb for 10 AWG or smaller, 40 in-lb for 8 AWG using a flat bladed screw driver.
12. Pull wire to verify.

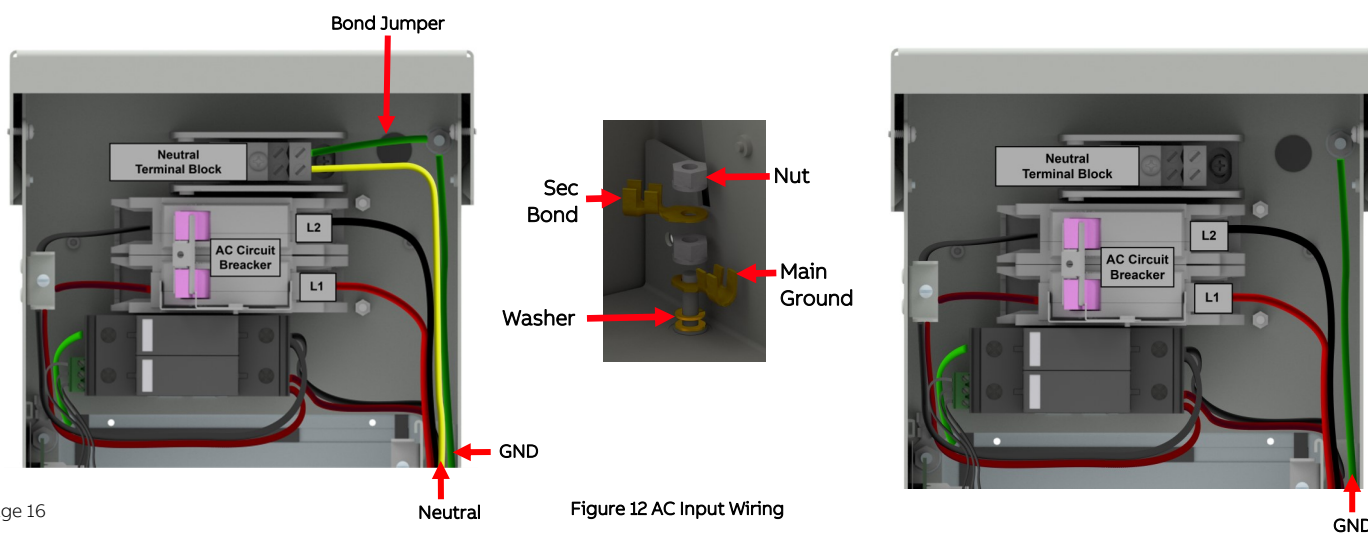

Figure 12 AC Input Wiring



## Step 7 - Final wire dressing and close the door

The field wiring compartment is closed after all wires are dressed and secured.

1. Pull all the alarm wires and DC cables out through the strain relief holes until excess wire slack is removed.
2. Secure the strain relief fittings in the holes on the bottom, using channel lock for snap in type strain relief as needed.
3. Dress the wire with a drip loop and visibly relaxed region outside the unit.
4. Strain relieve the external wire to the environment to maintain this relaxed region even under load.
5. Pull the AC cable out through the conduit excess slack is removed.
6. Tie the AC wires (L1, L2, N, and GND) with cable ties as appropriate along wire channel.
7. Dress the wire with a drip loop and visibly relaxed region outside the unit.
8. Strain relieve the external wire to the environment to maintain this relaxed region even under load.
9. Position the top dead-front cover on the chassis. Use a flat bladed screw driver to secure all captive screws. Torque to 5 in-lbs.
10. Repeat step #1 for the lower dead-front cover.
11. Close the front door, tighten the captive screw on the front door and secure the pad lock.

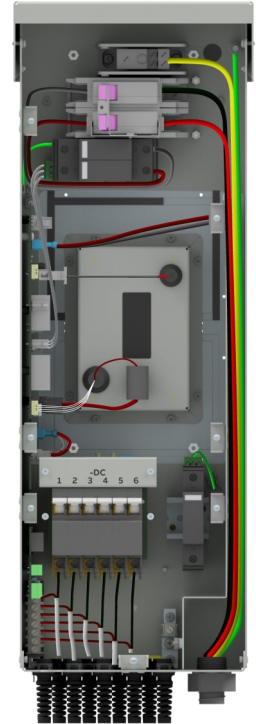

Figure 13 Final Wire Dressing

## Step 8 - Apply AC power and confirm -48V power

1. Terminate, insulate or protect the far end of the DC cables, as these will be energized when AC is applied.
2. Energize the AC source feeding the unit.
3. Turn on the mains circuit breaker at the top of the unit
4. Observe the LED illuminates green, indicating that DC is present on the output terminations.
5. Confirm that DC is present on the outputs by observing a signal from the repeater(s) or radio(s).
6. Test the alarm contacts by cycling the AC to off. Observe that AC and DC alarms are active when no AC is present.

## Information - Electrical connections

### Alarm Terminal Blocks

Alarm Closure pin definitions for isolated contact closures (relays rated at 75V<sub>DC</sub> and 0.5A with 3 to 5 ms switching times).

DC OK, SPD OK, and AC OK Alarm Terminal Blocks		
Pin #	Signal	Notes
1	N/C	Contact closure indicates alarm
2	Comm	
3	N/O	Contact open indicates alarm

Pin #	Signal	Notes
1	GND	
2	GND	

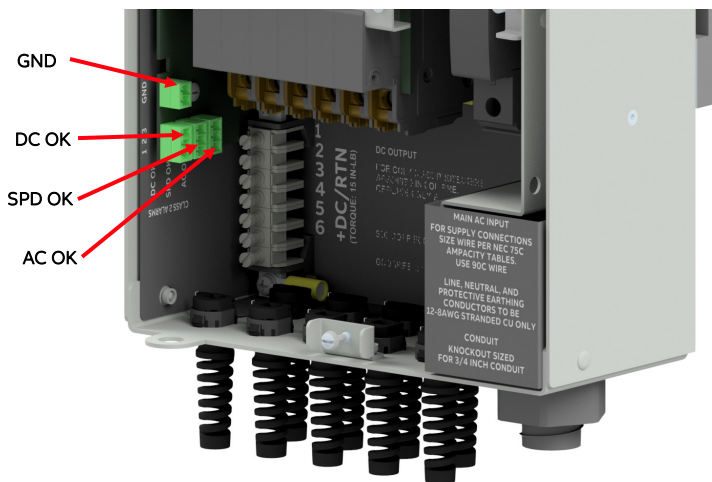

Figure 14 Alarm connections

### DC Output Connections

For -48V connections:

- Circuit Breaker Version: Directly wired to the circuit breaker itself or;
- Fuse Version: Wired to the terminal block aligned with its corresponding fuse holder

For +DC Returns: wired to the common return bus

**Note:** The output source is common and electrically protected from short circuit. Maximum current delivered is limited. When the output is short circuited, the unit will cycle on and off with a interval of about 14 seconds. Short circuit hiccup is disabled for the first 20 seconds after start up to support the inrush requirements of the load.

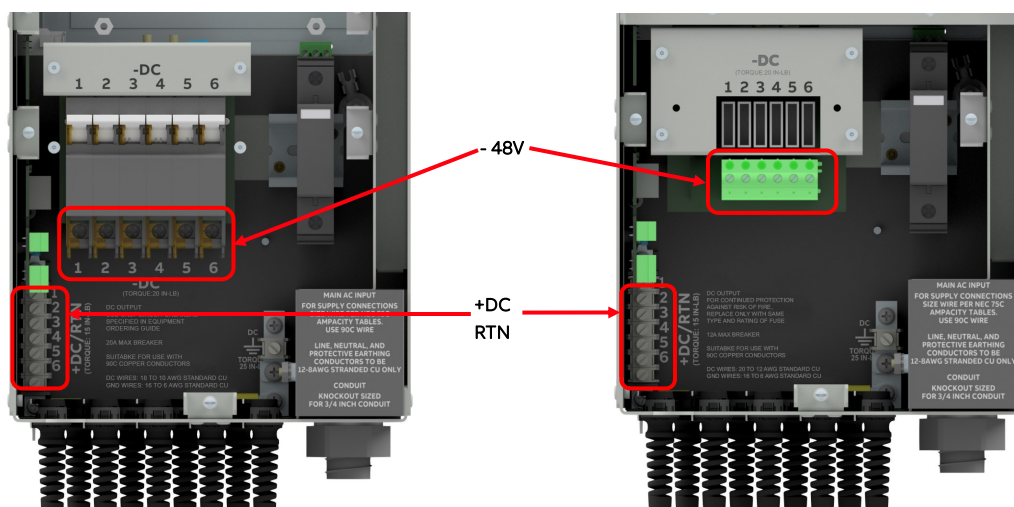

Figure 15 DC output connections

## AC Input Connections

### Configured as Service Entrance

- Line 1 and Line 2 connected directly to the AC breaker as shown.
- AC Neutral connected to terminal block and neutral terminal block bonded to ground
- AC Ground connected to chassis stud with provided ring terminal

### Not Configured as Service Entrance

- Line 1 and Line 2 connected directly to the AC breaker as shown.
- AC Neutral (if present) is connected to floating terminal block
- AC Ground connected to chassis stud with provided ring terminal

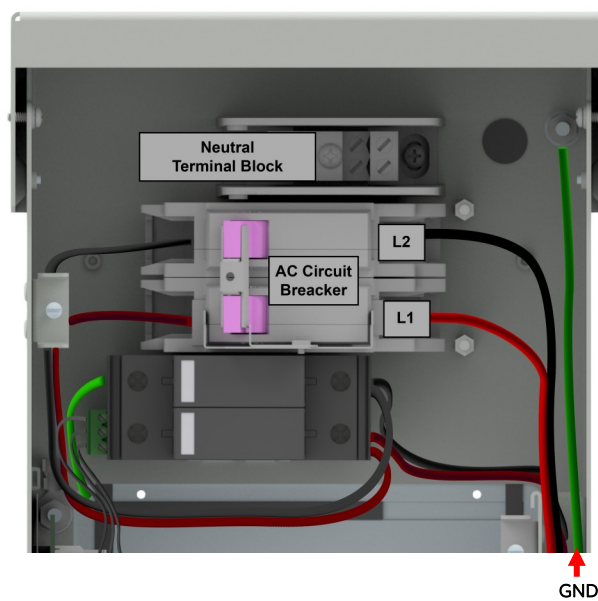
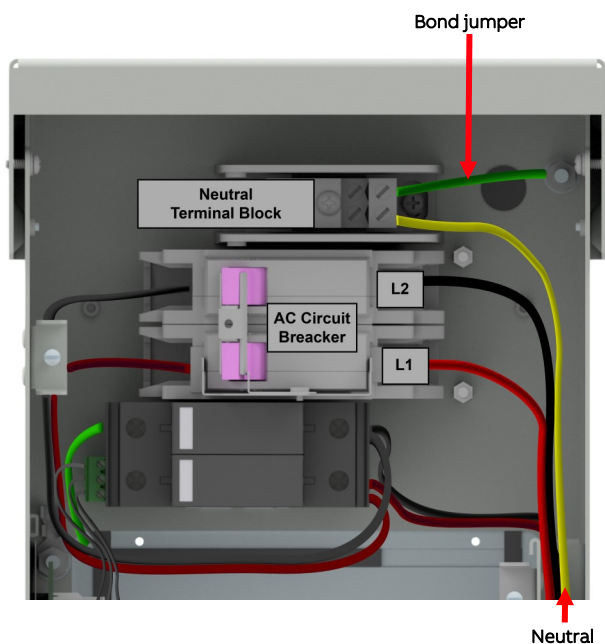

Figure 16 AC Input connections

## Information – LED States

State	State Description	LED Color/State	Customer Action
1	AC Fail	Off	AC Breaker is Off/Open or AC is not present at the input of unit.
2	DC Fail	Red	AC is present and breaker Closed/On, but module is not producing DC output.
3	SPD Fail	Red	AC is present and breaker Closed/On, DC power to the load, and the AC SPD, DC SPD, or both SPDs have failed.
4	DC Fail And SPD Fail	Red	AC is present and breaker is Closed/On, and both the DC and SPD Fail are present.
5	Normal	Green	No Alarms and everything Normal.

## Information - External electrical equipment

This equipment includes an embedded DC output surge protection network to mitigate risk of damage to itself from external transient events occurring on the DC output conductors. This device is not intended to be used as a surge suppression device for the externally connected devices being powered by the unit. Connected devices must provide their own suitable DC input transient suppression as dictated by the equipment's vendor for the installation site environment or per company or industry standards (e.g., ITU K series standards).

## Information - Lifting the unit

The rectifier assembly is less than 80 lbs. and should have two installers to place the unit into position to the pole or wall mounting bracket.

## Information - External icing

When external icing affects the access to the four hardware screws a plastic or rubber hammer can be used to break the ICE to remove the securing screws.

## Information - For retrofit applications

1. Unlock and open door of unit.
2. Turn mains breaker feeding the unit following Lock-Out Tag-Out procedures.  
**Warning:** line side of Mains breaker is still energized high voltage.
3. Remove power from source feeding mains breaker in the unit by following local regulatory and National Electric Code (NEC) practices to deenergize power from the AC meter
4. with a meter, confirm the AC input and DC outputs are all deenergized.
5. Remove the dead-front covers and disconnect wiring
6. Secure all wiring.
7. Remove straps holding the unit in position.
8. Remove the pole mounted unit.
9. Install the retrofit unit and secure with the appropriate mounting straps.
10. Install the electrical and dc output following removal using the installation procedure described earlier in this document.
11. Close all openings and power the input and verify the LED is now green.
12. Reinstall both dead - front covers and close and lock front door.

## Information - Touch up paint

Should any part of the unit coating be damaged, repaint using:

LVP Powder and Paints

RAL7035 Touch Up Paint - Light Grey - 12 oz Spray Can.

## Parts List

### Additional/Replacement Accessories

Ordering code	Amperage	Description
405006222	0.25A	GMT Fuse
3150439	0.5A	
405673146	1.33A	
405181983	2A	
406976985	3A	
406159061	5A	
405725433	7.5A	
406159236	10A	
407854197	12A	
406473959	15A	
450029223	5A	DC Breaker
450029222	10A	
450029220	15A	
450029219	20A	



## Specifications and Application

The AC input port of this device meets GR-1089 Table 4-2 First Level Lightning Surge test [IEC61000-4-5, Level 4 & ANSI C62.41- 2002 (6kV)] without external surge protection device (SPD). In regions that experience consistently higher lightning activity, consider adding an external Surge Protective Device (SPD) consistent with region specific, and network specific, best standard practice.

- Equipment Safety is Approved to UL62368-1 Equipment to be Installed Outdoors in environments with ambient temperature up to 65°C.
- Equipment and subassembly ports:
  1. are suitable for connection to intra-building or unexposed wiring or cabling;
  2. can be connected to shielded intra-building cabling grounded at both ends.
- Grounding / Bonding Network – Connect to an Isolated Ground Plane (Isolated Bonding Network) or an Integrated Ground Plane (Mesh-Bonding Network or Common Bonding Network).
- Installation Environment - Install where NEC applies.
- Enclosure is rainproof.
- Internal rectifier is in an IP 6x enclosure.

## Ordering Information

Ordering Code	Model	Power (W)	Redundancy	Backup	Load Breakers	Load Fuses	Surge
1600361512A	RP450-48-PS1-DC6B-SRG	450	NO	NONE	6	-	YES
1600408704A	RP450-48-PS1-DC6F-SRG	450	NO	NONE	-	6	YES

## Change History (excludes grammar & clarifications)

Version	Date	Description of the change
1.0	08/05/2022	Initial release



---

## QUICK START GUIDE

### ABB

601 Shiloh Rd.  
Plano, TX USA

[abbpowerconversion.com](http://abbpowerconversion.com)

We reserve the right to make technical changes or modify the contents of this document without prior notice. With regard to purchase orders, the agreed particulars shall prevail. ABB does not accept any responsibility whatsoever for potential errors or possible lack of information in this document.

We reserve all rights in this document and in the subject matter and illustrations contained therein. Any reproduction, disclosure to third parties or utilization of its contents – in whole or in parts – is forbidden without prior written consent of ABB.

Copyright© 2021 ABB  
All rights reserved