

# BPS48 Power Systems

Compact, High Density, Rack Mounted Power System



## TABLE OF CONTENT

03	Overview
04	BP040 Rectifier Information
05 - 07	Pulsar Plus Controller Information
12	Step 1: Base Power System
14	Step 2: Expansion Bus Kits and AC Accessories
14	Step 3: Rectifier and Converter Modules
15 - 17	Step 4: Distribution Components
18	Step 5: Alarm Input/Output Cables
18 - 19	Step 6: Battery Monitoring
20	Service and Warranty

## Overview

BPS48 Power Systems are easy to setup and operate with a broad range of applications in outside plant and customer premise locations. The controller can be configured using either the front panel display, a laptop computer connected to the local port, or remotely using the Ethernet connection. Battery management features and options include slope thermal compensation, low voltage battery disconnect, battery high temperature alarm and battery shorted cell detection. Ideally suited for applications where space and durability in harsh environments are critical.

## Shelf Options

BPS48 Power system is a -48Vdc compact power system that is as small as 5U up to 11RU (8.75 in./222 mm to 22.25in./565 mm) and mounts in either 19" or 23" wide frameworks. The BPS Power system is a front to rear airflow system consisting of rectifiers, controller, battery monitoring and integrated or external distribution options.

## Rectifier Options

The BPS48 Power System offers a compact (42w/in<sup>3</sup>), 2000W, hot-pluggable rectifier with input voltages both in 120V and 208/240V nominal for worldwide 50/60Hz applications. The 19" shelf supports 5 rectifiers for 200A per shelf and the 23" shelf supports A six position rectifier shelf (300A) with external distribution panel accommodates up to 26 bullet breaker positions. The entire rectifier line is designed for operation in the temperature range -40°C to +75°C. The BPS Power System is NEBS Level 3 certified and Zone 4 rated.

## Galaxy Pulsar\* Plus Controller

The Galaxy Pulsar Plus is used throughout many of the OmniOn Power DC Power products including BPS, Infinity, CPS, and GPS with the only differentiator being the form factor which is scaled to meet the nature of the application. The controller utilizes standard network management protocols allowing for advanced network supervision with SNMP communications to deliver extensive monitoring and control features with both local and remote access.

## Advantages

- Compact power plant
- -48V up to 800A
- High availability wireless telecom applications
- Telecom service providers
- Wireless service providers
- Cable service providers
- Industrial and Rail communication systems
- Efficiency greater than 96%

## BP040 Rectifier

- Compact – 1RU form factor providing high power density (42 W/in<sup>3</sup>)
- Shallow depth to allow for systems to be installed in ETSI depth applications where plant depth is a concern.
- Plug and Play-installation of the rectifier in a shelf connected to a compatible system controller initializes all set up parameters automatically. No adjustments are needed.
- Extended service life – parallel operation with automatic load sharing ensures that parallel units are not unduly stressed even when a unit fails or is removed.
- Monitoring / control – the built in microprocessor controls and monitors all critical rectifier functions and communicates with the system controller using the built in Galaxy Protocol serial interface.
- Fail safe performance – hot insertion capabilities allow for converter replacement without system shutdown; soft start and inrush current protection prevent nuisance tripping of upstream breakers.



## Applications

- Telecommunications Networks
- Digital Subscriber Line (DSL)
- Indoor/Outdoor Wireless
- Routers/Switches
- Fiber in the Loop
- Transmission
- Data Networks
- Distributed Antenna Systems

## Key Features

- Extended temperature range
- Redundant fan cooling
- Front panel LED indicators
- 1U height, hi power density
- 240/ 230 / 208 / 120V AC input
- Digital load sharing
- Hot pluggable
- RoHS compliant

## Rectifier Specifications

INPUT		BP040AC48TEZ
Voltage Range		95-265Vac
Input Current		13.2-11A @ 100-120Vac 10.7-8.9A @ 200-240Vac
Input Frequency		45 – 66Hz
Power Factor		0.98 at >50% load
Efficiency		> 96% (Peak 96.2%)
Total Harmonic Distortion		<5% @loads over 50%

Output		BP040AC48TEZ
Voltage Adjust Range		42-58Vdc
Voltage Nominal		54.5V
Regulation (with controller)		±0.05%
Ripple		100mVrms
Output Current		41.7A @48V
• High-Line		37A @54.5V
• Low-Line		22A @54.5V
Heat Dissipation @ max output		70W / 238 BTU/hr.

## Pulsar Plus Controller

The Pulsar Plus family of controllers provides system monitoring and control features for BPS, Infinity, CP, and other power systems. These controllers monitor and control system components including rectifiers, converters, and distribution modules via a multi-drop RS485 digital communications bus. System status, parameters, settings, and alarm thresholds can be viewed and configured from the controller's front panel display. Assignment and configuration of alarm inputs and output relays can be performed from a laptop computer connected to a local RS-232 or Ethernet port, or by remote access is through a secure network connection to the World Wide Web (internet) or your enterprise network (intranet). An optional modem is also available.

This controller utilizes standard network management protocols allowing for advanced network supervision. The OmniOn Power Galaxy Manager\* software is the centralized visibility and control component of a comprehensive power management system designed to meet engineering, operations and maintenance needs. The Galaxy Manager client-server architecture enables remote access to system controllers across the power network, featuring ECO Priority advanced monitoring features which provides detailed energy source analysis to help better customize your renewable energy resources.



## Applications

- Telecommunications Networks
- Digital Subscriber Line (DSL)
- Indoor/Outdoor Wireless
- Routers/Switches
- Fiber in the Loop
- Transmission
- Off-Grid/On-Grid Renewable Energy Sites
- Data Networks
- PBX
- DHCP for plug-n-play
- FTPS for rapid backup and upgrades
- HTTPS for standard web pages and browsers
- Compatible with Galaxy Manager and other management packages
- Shielded RJ-45 interface referenced to chassis ground

## Key Features

### Remote Access and Features

- Integrated 10/100Base-T Ethernet Network
  - TCP/IP with IPV6 Capability
  - SNMP V3 for management
  - SMTP for email
  - Telnet for command line interface
- Password protected security levels: User, Super-User, Administrator for all access
- Ground-referenced RS232 system port
- ANSI T1.317 command-line interface
- Modem access support
  - Remote via external modem
  - Callback security
- EasyView2, Windows-based GUI software for local terminal or Modem access
- ECO Priority controls and features

## Key Features (Continued)

- Advanced generator controls to help minimize fuel consumption for off grid applications
- ECO Energy Management allowing for non-ECO sources outputs to be minimized while ECO resources are available
- Source and load trend logging

## Standard System Features

- Monitor and control of more than 40 connected devices
  - Robust RS485 system bus
- Standard and user defined alarms
  - Alarm test
  - Assignable alarm severity: Critical, Major, Minor, Warning, and record-only
  - 10 alarm relays (7 user assigned)
- Rectifier management features
  - Automatic rectifier restart
  - Active Rectifier Management ARM (energy efficiency)
  - Remote rectifier (on/off)
  - Reserve Operation
  - Automatic rectifier sequence control
  - N + X redundancy check
- Multiple Low Voltage Load and Low Voltage Battery Disconnect thresholds
- Configuration, statistics, and history
  - All stored in non-volatile memory
  - Remote/local backup and restore of configuration data
- Industry standard defaults
  - Customer specific configuration available
- Remote/local software upgrade
- Basic, busy hour, and trend statistics
- Detailed event history
- User defined events and derived channels

## Standard Battery Management Features

- Float/boost mode control

- Manual boost
- Manual timed boost locally, T1.317, and remotely initiated
- Auto boost terminated by time or current
- Battery discharge testing
  - Manual (local/remote)
  - Periodic
  - Plant Battery Test (PBT) input driven
  - Configurable threshold or 20% algorithm
  - Graphical discharge data
  - Rectifiers on-line during test
- Slope thermal compensation
  - High temperature
  - Low temperature
  - Step temperature
  - STC Enable/Disable, low temperature Enable/Disable
  - Configurable mV/°C slopes
- State of charge indication
- High temperature disconnect setting
- Reserve-time prediction
- Recharge current limit
- Emergency Power-Off input

## Integrated Monitoring Inputs/Outputs

- System plant voltage (accuracy  $\pm 0.5\%$ , resolution 0.01V)
- One system shunt (accuracy  $\pm 0.5\%$  full scale, resolution 1A)
  - Battery or load
  - Mounted in the return side of DC bus
- Up to 15 binary inputs
  - 6 inputs close/open to battery
  - 9 input close/open to return
  - User assignable
- Up to 7 Form-C output alarms (60VDC @ .5A)

- User assignable
- 1-Wire™ bus devices
  - Up to 16 temperature probes (QS873)
  - Up to 6 mid-string monitors (ES771)
- Monitor and control of more than 40 connected devices
- Management information from polling or alarms received from alarm traps from multiple sites are available on one screen via the inter/intranet
- Trend user selected data over time
- Automatic or manual report generation
- Standard engineering tools like reserve time calculators and cable voltage drop analyzer

### Galaxy Manager Compatible

- Centralized web server and database with multiple user access to live or managed data with drill down to problem details

## Specifications

GENERAL	
Operating Voltage	±24 Vdc, ±48 Vdc (Range: ±18 to ±60 Vdc)
Input Power	Less than 7W
Operating Temperature	-40°C to +75°C (-40°F to 167°F)
Operating Relative Humidity	0 - 95% (non-condensing)
Storage Temperature Range	-40°C to +85°C (-40°F to 185°F)
Physical Specifications	Sizes vary by packaging option
Display	8-line by 40-character with alarm context sensitive backlit LCD

SAFETY AND STANDARDS COMPLIANCE	
NEBs	Evaluated by independent NRTL test lab to Telcordia GR63, Issue 3 and GRI089-CORE, Issue 6
Safety	ANSI/UL60950-1-2014 and CAN/CSA C22.2 No. 60950-1-07, Second Edition + A2:2014 (MOD), dated October 14, 2014
RoHS	Compliant to RoHS II EU Directive 2002/95/EC/RoHS 6/6
EMC	European Directive 2014/30/EU; EN55032, Class A, EN55035; FCC, Class A; GRI089-CORE, Issue 6

AGENCY CERTIFICATIONS	
NEBs Level 3	Evaluated by independent NRTL test lab to Telcordia GR63, Issue 3 and GRI089-CORE, Issue 6
EMC	European Directive 2014/30/EU; EN55032, (CISPR32) Class A, EN55035 (CISPR24)
Safety	Underwriters Laboratories (UL) Listed per Subject Letter 1801: Power Distribution Center for (CSA 22.2 950): Safety of Information Technology Equipment

## BPS System

The BPS power system may be configured as a 19" or 23" rack mounted solution supporting a -48Vdc bus. The BPS includes dedicated 48V, 48V Battery, and return buses. The primary voltage capacity is 800A at 48V. The Battery bus is rated to support the full output current at 40Vdc on the bus. The system includes low voltage battery disconnect option. A low voltage load disconnect option can be used on second distribution panel for load shedding to maintain critical loads. Systems can be shipped alone or packaged into an earthquake Zone 4 frame with optional battery trays.



## Applications

- Wireless Telecom Networks
- Indoor/Outdoor Wireless
- Cable TV Networks
- Transmission and Regen Sites
- Data Networks
- Customer Point of Presence

## Features

- Compact BP series rectifier for high density power in a shallow mounting depth.
- Digital load sharing.
- Back-bias powered system and rectifiers controllers to ensure peak plant operation throughout the plants operation.
- DC Distribution with each position selectable between load and battery breakers.
- Temperature hardened harsh environments. (-40°C to +75°C).
- Compact size: Base System with 1 power shelf occupies 5 RU (8.75 in) of 19" or 23" rack space (14.5"-24" depth).
- Frame options-Factory installed in 7ft or 42" tall, 19" or 23" wide frame or field installed in user supplied frame.
- Optional battery earthquake zone 4 rated battery trays with either quick connections or integrated battery breakers.
- Bulk Battery connections, LVBD and LVLD options.
- Plug-N-Play Pulsar Plus controller with Web based interface for local and remote (LAN) access.
- Distribution options include 3A-300A bullet style circuit breakers, and GMT fuses.
- RoHS 10 Compliant



## Specifications (Continued)

INPUT	MIN	TYP	MAX
Voltage Range • High-Line • Low-Line	175Vac 85Vac	220Vac 110Vac	265Vac 140Vac
Frequency	45Hz	60Hz	66Hz
Power Factor	98%	99.5%	
Total Harmonic Distortion			5%

### PRIMARY OUTPUT

Nominal Voltage	-48Vdc
Output Current	800A
Vo Setpoint (factory)	-54.5Vdc±1%
Vo Range	-42Vdc to -58Vdc
Regulation	±0.5%

### ENVIRONMENTAL

Operating Temperature	-40°C to +75°C (-40°F to 167°F)
Storage Temperature	-40°C to +85°C (-40°F to 185°F)
Humidity	95% non-condensing
Altitude	4000M (for altitudes above 2000M, peak operating temperature de-rates 0.656° C /100M; 4000M peak temperature rating is 62°C)

### SAFETY AND STANDARDS COMPLIANCE

NEBs	Evaluated by independent NRTL test lab to Telcordia GR63-CORE and GR1089-CORE [Level 3] ISSUE 7
Safety	ANSI/UL62368-1 and CAN/CSA C22.2 No. 62638-1, IEC62638-1
RoHS	Compliant to 2011/65/EU and amended Directive (EU) 2015/863
EMC	European Directive 2014/30/EU; EN55032, Class A; EN55035; FCC, Class A; GR1089-CORE ISSUE 7

### AGENCY CERTIFICATIONS

CSA	ANSI/UL62638-1 and CAN/CSA C22.2 No. 62638-1
EMI/EMC	European Directive 2014/30/EU; EN55032 (CISPR22) Class A; EN55035 (CISPR35)
NEBS LEVEL 3	GR1089-CORE Special equipment room cooling may be needed - heat dissipation exceeds values of GR-63 Table 4-5

## Specifications (Continued)

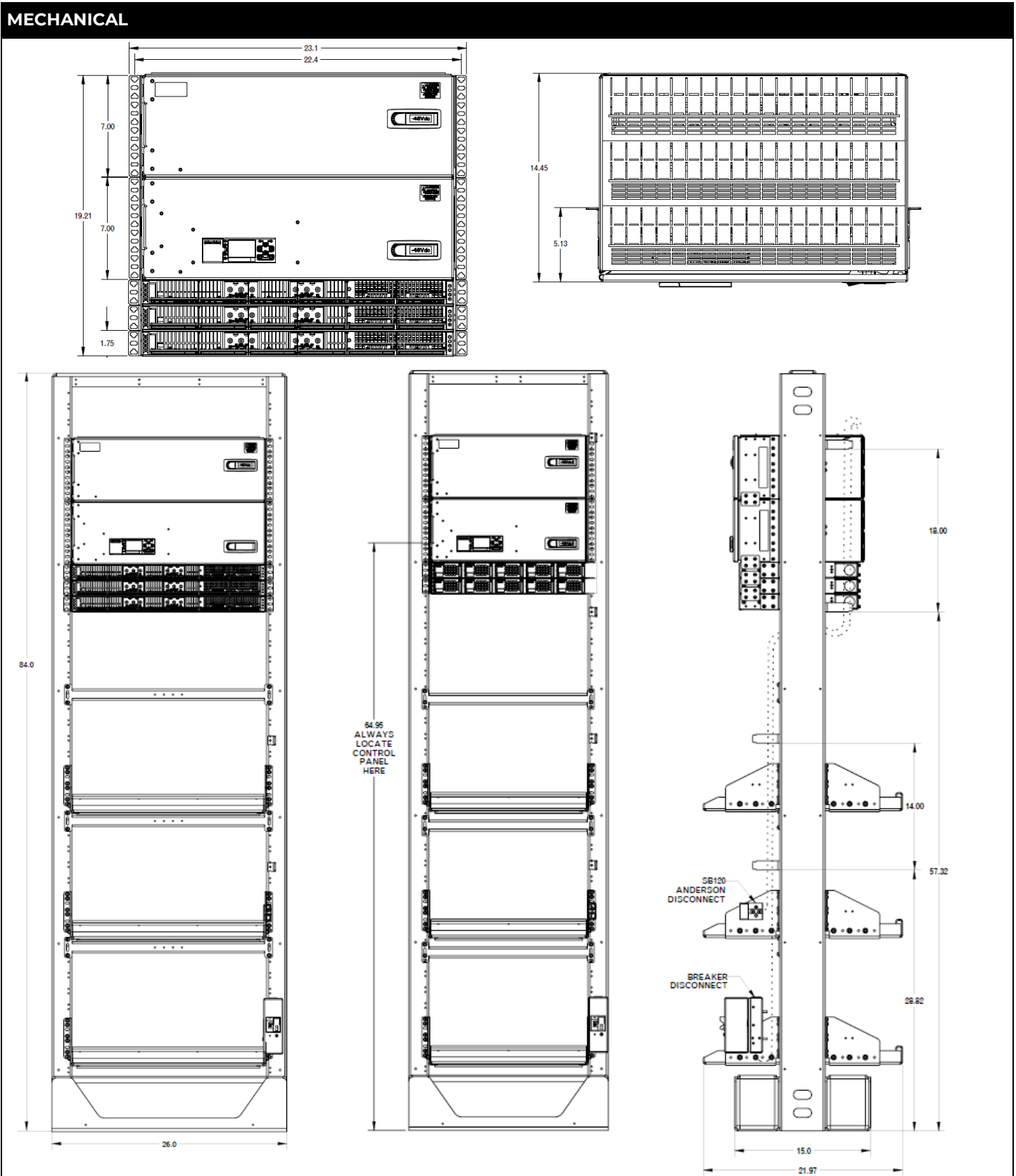

## Specifications (Continued)

AC Input	DESCRIPTION	SCHEMATIC
AC5	Individual Feed, Terminal Strip, 3/4" Conduit or Cord Grip	

## DC Distribution

Image	Schematic
	<p>Optional LVBD</p> <p>Rectifiers</p> <p>1 to A Positions</p> <p>Configurable Battery Breaker Positions; 2-Hole 1/4" studs on 5/8" centers</p> <p>1 to B Positions</p> <p>Configurable Load Breaker Positions; 2-Hole 1/4" studs on 5/8" centers</p> <p>Optional Supplemental Load Breaker Positions; 2-Hole 1/4" studs on 5/8" centers</p> <p>A = 20 Positions for a 19" and 26 Positions for a 23" System; Each position is configurable between battery and load.            B = 20 Positions for a 19" and 26 Positions for a 23" System; Each position is a load breaker position only</p>

## Bulk Battery Connections





19" Single Voltage system with Battery Breaker Bus	23" Single Voltage system with Battery Breaker bus
<p>Return Bus</p> <p>LVBD</p> <p>Bulk Battery Bus</p>	<p>Return Bus</p> <p>LVBD</p> <p>Bulk Battery Bus</p>

## Product Documentation

CC848815341	Advanced Features User Guide for the Pulsar Plus Controller, 167-792-183
8600481128P	BPS -48V Power System Quick Start Guide

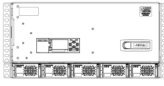
## Step 1: Select the Base Power System







### Single Voltage System -48V Battery Breaker Input, 19" Width

OUTPUT RATING	DESCRIPTION	AC INPUT	LVD	FRAME	ORDERING CODE	MODEL	PHOTO
<div style="background-color: #003366; color: white; padding: 5px; text-align: center; font-weight: bold;">-48V</div> 200A	200A BPS Power system equipped with 5 rectifier positions and 20 distribution positions System - 5RU	AC5	No	None	1600469909A	BPS48-19-AC5-PS5-DC1E	
		AC5	Yes	None	1600469914A	BPS48-19-AC5-PS5-DC1E-LVBD	
<div style="background-color: #003366; color: white; padding: 5px; text-align: center; font-weight: bold;">-48V</div> 400A	400A BPS Power system equipped with 10 rectifier positions and 20 distribution positions System - 6RU	AC5	No	None	1600469911A	BPS48-19-AC5-PS10-DC1E	
		AC5	Yes	None	1600469915A	BPS48-19-AC5-PS10-DC1E-LVBD	
<div style="background-color: #003366; color: white; padding: 5px; text-align: center; font-weight: bold;">-48V</div>	400A BPS Power system equipped with 10 rectifier positions and 40 distribution positions System - 10RU	AC5	No	None	1600469912A	BPS48-19-AC5-PS10-DC2E	
		AC5	Yes	None	1600469916A	BPS48-19-AC5-PS10-DC2E-LVBD	
<div style="background-color: #003366; color: white; padding: 5px; text-align: center; font-weight: bold;">-48V</div>	600A BPS Power system equipped with 15 rectifier positions and 40 distribution positions System - 11RU	AC5	No	None	1600469913A	BPS48-19-AC5-PS15-DC2E	
		AC5	Yes	None	1600469917A	BPS48-19-AC5-PS15-DC2E-LVBD	

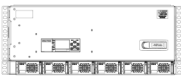
\* Integrated MODBUS adapter included and attached to the system controller

## Step 1: Select the Base Power System (continued)

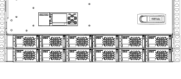
### Single Voltage System -48V Battery Breaker Input, 23" Width

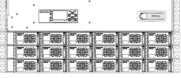
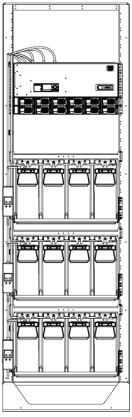
OUTPUT RATING	DESCRIPTION	AC INPUT	LVD	FRAME	ORDERING CODE	MODEL	PHOTO
<b>-48V</b>	240A BPS Power system equipped with 6 rectifier positions and 26 distribution positions System - 5RU	AC5	No	None	1600469902A	BPS48-23-AC5-PS6-DC1E	
		AC5	Yes	None	1600469904A	BPS48-23-AC5-PS6-DC1E-LVBD	
<b>-48V</b>	480A BPS Power system equipped with 12 rectifier positions and 26 distribution positions System - 6RU	AC5	No	None	1600469903A	BPS48-23-AC5-PS12-DC1E	
		AC5	Yes	None	1600469905A	BPS48-23-AC5-PS12-DC1E-LVBD	
<b>-48V</b> 480A	480A BPS Power system equipped with 12 rectifier positions and 52 distribution positions System - 10RU	AC5	No	None	1600469906A	BPS48-23-AC5-PS12-DC2E	
		AC5	Yes	None	1600469907A	BPS48-23-AC5-PS12-DC2E-LVBD	
<b>-48V</b> 720A	720A BPS Power system equipped with 18 rectifier positions and 52 distribution positions	AC5	No	None	1600469908A	BPS48-23-AC5-PS18-DC2E	
		AC5	Yes	None	1600469910A	BPS48-23-AC5-PS18-DC2E-LVBD	
<b>-48V</b> 480A	480A BPS Power system equipped with 12 rectifier positions and 26 distribution positions System mounted in a 7' frame. Frame is equipped with 3, 24" deep Battery trays prewired to the system with 2/0 wiring and 200A shelf mounted breakers-84"  (Batteries not included)	AC5	No	Yes	1600481369A	BPS48-23-AC5-PS12-DC1E-7FTR-3BT3	

## Step 2: Select Expansion Kits and AC Input Accessories

**Battery Bus Extension Kits**—Used for expanding battery bus connections in single voltage systems

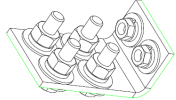
ORDERING CODE	DESCRIPTION	SYSTEM COMPATIBILITY	
850022254	Battery Lug Connection Bus Kit	All Systems	

**Supplemental Rectifier Shelf Kits - Used for Installing Additional Rectifier Shelves to an BPS System in the Field**

ORDERING CODE	DESCRIPTION	Notes:
1600449176A	BPS AC5 19in Supplemental Shelf Kit	Each kit includes: Rectifier shelf with mounting hardware, busbar interconnects with hardware
1600470478A	BPS AC5 23in Supplemental Shelf Kit	



**AC Input Adapters - FUTURE RELEASE**

ORDERING CODE	DESCRIPTION	Notes:
TBD	TBD	NOT YET AVAILABLE

## Step 3: Select Rectifier and Converter Modules

### Rectifier Modules

BPS rectifiers are designed to operate in all BPS based power systems. They are designed and qualified to operate 40°C to +55°C with extended operation to +75°C. The 48V rectifiers are programmable from 42 - 58Vout, whereas the 24V rectifiers are programmable from 21 - 29Vout. All rectifiers of the same output voltage type will operate in parallel and load share based on the percentage of load capacity of each rectifier, ensuring that no one rectifier is loaded more than others.

ORDERING CODE	Description	Input	Output	Float	Max	Picture
1600420226A 	BP040AC48ATEZ	95 - 140Vac	1200W	22A	24A (50V)	
		175 - 305Vac	2000W	37A	40A (50V)	
		Input Current	12A - 8.9A			
		Heat Release	98 Watts	334 BTU/hr.		

## Step 4: Distribution Components



### Bullet Style Load Circuit Breakers

Infinity distribution panels support plug-in (bullet style) breakers modules. Larger breakers can be 2 or even 3 poles. The multi-pole breakers require output bus bar adapters, with returns either using the battery return bus or additional adapters connected to the load return bus.



Ordering Code	Amperage	CB Positions	Min Wire Gauge	Picture
407998137	3	1	10	
407998145	5	1	10	
407998152	10	1	10	
407998160	15	1	10	
407998178	16	1	10	
407998186	20	1	10	
407998194	25	1	10	
407998202	30	1	10	
408213486	40	1	10	
407998210	45	1	8	
407998228	50	1	8	
407998236	60	1	6	
407998244	70	1	6	
407998251	80	1	4	
407998269	90	1	4	
407998277	100	1	2	
CC848808551	100	2	2	
408185353	125	2	2	
408185346	150	2	1	
408544076	200	2	3/0	
408564941	200	3	3/0	
408573975	225	3	3/0	
408535752	250	3	4/0	
450046922	300	3	4/0	
CC848756916	2-pole Adapter bus for 100-150A breakers; used for ¼"-20 on 5/8" lugs (order 2 per 2 pole breaker to accommodate load and return lugs)			
850021775	2-pole Adapter bus for 100-150A breakers; used for 3/8" on 1" lugs (order 2 per 2 pole breaker to accommodate load and return lugs)			
CC848756924	3-pole Adapter bus for 200-250A breakers; used for 3/8" on 1" lugs; off-center connection (order 2 per 3 pole breaker to accommodate load and return lugs)			
850021955	3-pole Adapter bus for 200-250A breakers; used for 3/8" on 1" lugs; center connection (order 2 per 3 pole breaker to accommodate load and return lugs)			

## Step 4: Distribution Components (continued)

### TPS Fuse and Fuse Holders

Ordering Code	Amperage	Picture
406700567	3	
406700583	5	
406700591	6	
406700609	10	
406700617	15	
406700625	20	
406700633	25	
406700641	30	
406700658	40	
406700674	50	
406700682	60	
406700690	70	
CC408618020	80	
CC408618037	90	
CC408618045	100	
CC408618061	125 (Max of 3, 125A fuses per side. A Space must be left between fuses)	
407845197	0.18 Alarm Fuse	
406473959	Bullet Fuse Holder, TFD-101-011-09 (Alarm on Removal or Blown Fuse)	
CC109103157	Bullet Fuse Holder, TFD-101-011-10 (Alarm on Removal or Blown Fuse)	

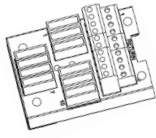

### Bullet Style GMT Fuse Holders and GMT Fuses

Ordering Code	Amperage	Picture
405006222	0.25	
3150439	0.5	
405673146	1.33	
405181983	2	
406976985	3	
406159061	5	
405725433	7.5	
406159236	10	
407845197	12	
406473959	15	
CC109103157	6-pos GMT Bullet Fuse Holder (Requires 2 bullet positions) Note: Max Fuse Load is 12A	
1600316837A	10-pos GMT Bullet Fuse Holder (Requires 3 bullet positions) Note: Max Fuse Load is 15A	
408515823	Fuse Puller	



### Step 4: Select Distribution Component (Continued)



#### Bullet Battery Circuit Breakers (Yellow Handle) (Alarms on Mid-Trip and in Off Position)

ORDERING CODE	AMPERAGE	PHOTO
CC408612758	30	
CC408612766	40	
CC408612774	45	
CC408574370	50	
408560123	60	
CC408574387	70	
CC408574395	100	
CC408574404	125 (2-pole)	
CC408574412	150 (2-pole)	
CC408574420	200 (2-pole)	
CC408645295	250A (3-pole)	
CC109106548	100A battery bullet bus strap (substitute for battery breaker)	

## Step 5: Select Alarm Output and Input Cables

Ordering Code	Description	Picture
CC848890153	5ft Auxiliary input alarm cable for Pulsar Plus Controller	
CC848865980	15ft Auxiliary input alarm cable for Pulsar Plus Controller	
CC848817651	50ft Auxiliary input alarm cable for Pulsar Plus Controller	
CC848817668	150ft Auxiliary input alarm cable for Pulsar Plus Controller	
CC109157442	15ft alarm output cable for Pulsar Plus Controller	
CC848817635	50ft alarm output cable for Pulsar Plus Controller	
CC848817643	150ft alarm output cable for Pulsar Plus Controller	

## Step 6: Select Battery Monitoring

Ordering Code	Description	Application	Picture
CC109142980	QS873A Thermal Probe	(A)	
150026698	QS873B Ambient Probe	(A)	
CC848817024	10 ft wire set	(B: thermal probe to controller)	
CC109157434	20 ft wire set	(B: thermal probe to controller)	
850052679	40 ft wire set	(B: thermal probe to controller)	
CC848822560	1 ft wire set	(C: thermal probe to thermal probe)	
848719803	5 ft wire set	(C: thermal probe to thermal probe)	
CC848822321	10 ft wire set	(C: thermal probe to thermal probe)	
850027334	20 ft wire set	(C: thermal probe to thermal probe)	
7000253598A	30 ft wire set	(C: thermal probe to thermal probe)	
8600089209P	40 ft wire set	(C: thermal probe to thermal probe)	
108958422	ES771A Battery Voltage Monitor Card		
CC848791517	2-1/2 ft. wire set	(D: ES771A to thermal probe)	
CC848797290	6 ft. wire set	(D: ES771A to thermal probe)	
848719829	10 ft. wire set	(D: ES771A to thermal probe)	
CC848791500	4 ft. wire set	(G:ES771A to ES771A or controller)	
848652947	10 ft wire set	(G:ES771A to ES771A or controller)	
555052-1	In Line Coupler	(G: extension coupler)	

Temperature probes are needed for battery monitoring . They are connected to each battery or battery string to provide slope thermal compensation and temperature alarms

Step 6: Select Battery Monitoring (Continued)

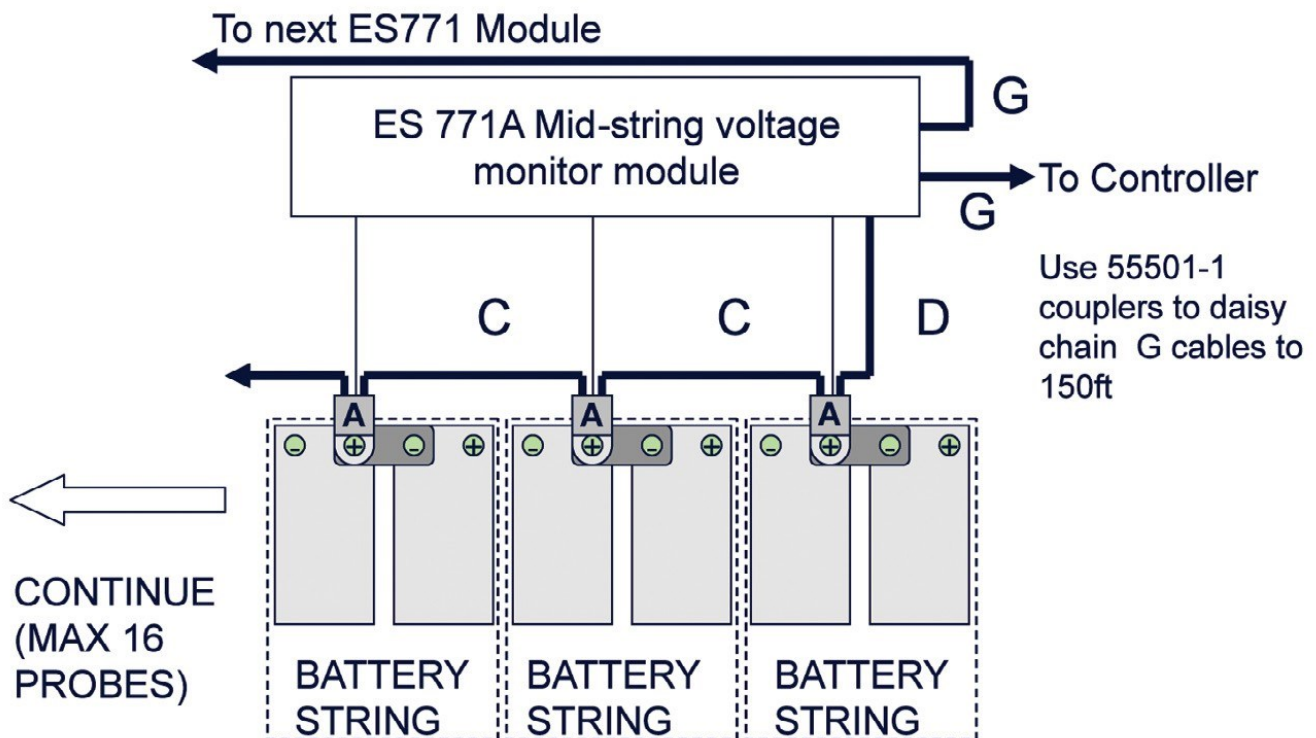
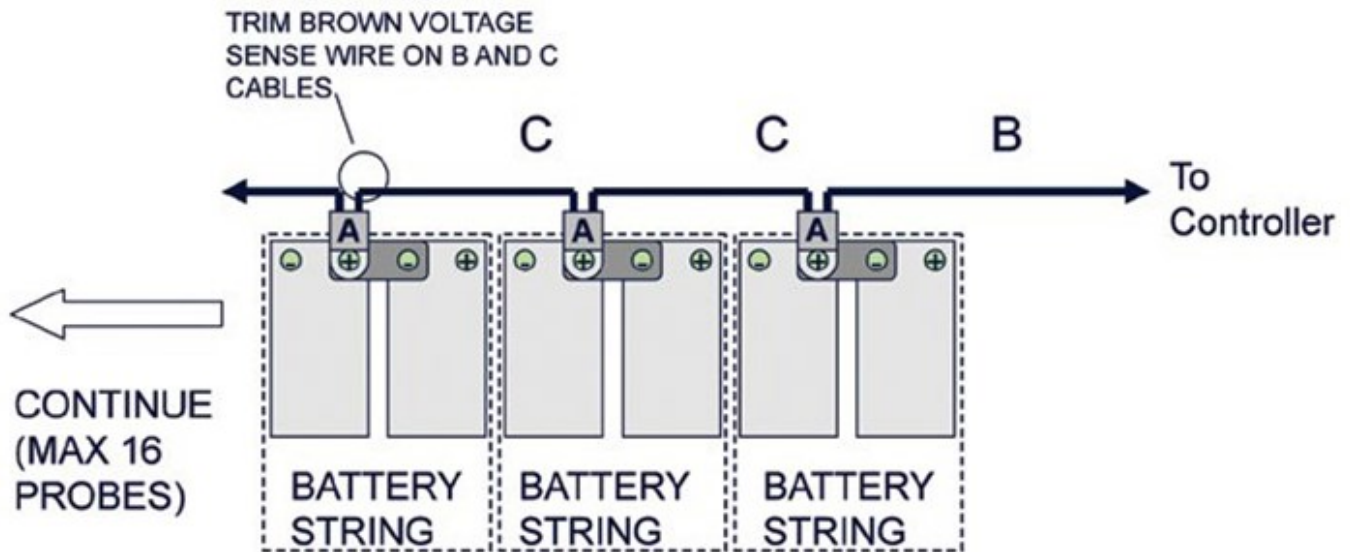

## Reliability

- Distributed fault tolerance
- Proven field performance
- Controller continuity Intelligence
- Industry leading controller features
- Ethernet interface for remote access
- Centralized network management Investment Protection
- Module Compatibility
- Power Shelf Growth
- Renewable Energy Ready
- Flexible Upgrade Options On Time Delivery
- Standard building blocks
- 4 - 6 week availability
- 24/7 technical support

## Management Visibility

Galaxy Manager\* software is the centralized visibility and control component of a comprehensive power management system designed to meet engineering, operations and maintenance needs. The Galaxy Manager client-server architecture enables remote access to system controllers across the power network.

- Dashboard display with one-click access to management information database
- Trend analysis
- Scheduled or on demand reports
- Fault, configuration, asset, and performance management

## Training

OmniOn Power offers on-site and classroom training options based on certification curriculum. Technical training can be tailored to individual customer needs. Training enables customers and partners to more effectively manage and support the power infrastructure. We have built our training program on practical learning objectives that are relevant to specific technologies or infrastructure design objectives.

## Service & Support

OmniOn Power field service and support personnel are trusted advisors to our customers always available to answer questions and help with any project, large or small. Our certified professional services team consists of experts in every aspect of power conversion with the resources and experience to handle large turnkey projects along with custom approaches to complex challenges. Proven systems engineering and installation best practices are designed to safely deliver results that exceed our customers' expectations.

## Warranty

OmniOn Power is committed to providing quality products and solutions. We have developed a comprehensive warranty that protects you and provides a simple way to get your products repaired or replaced as soon as possible.

For full warranty terms and conditions please go to

[omnionpower.com](https://omnionpower.com)



**OmniOn Power Inc.**

601 Shiloh Rd.  
Plano, TX USA

[omnionpower.com](http://omnionpower.com)

We reserve the right to make technical changes or modify the contents of this document without prior notice. OmniOn Power does not accept any responsibility for errors or lack of information in this document and makes no warranty with respect to and assumes no liability as a result of any use of information in this document.

We reserve all rights in this document and in the subject matter and illustrations contained therein. Any reproduction, disclosure to third parties or utilization of its contents – in whole or in parts – is forbidden without prior written consent of OmniOn Power. This document does not convey license to any patent or any intellectual property right. Copyright© 2024 OmniOn Power Inc. All rights reserved.